

FIRE/EMS PRICE BOOK

M130 Effective
4-1-2018



2018

LIGHTS & SIRENS

Innovation for those that
provide safety.



Includes products from price groups [M14](#) | [M19](#) | [M25](#) | [M05](#)

www.fedsig.com

Federal Signal is The Driving Force™ behind the technology that provides safe and reliable emergency warning for first responders. It is our commitment to engineer the most reliable and high-performing products for your emergency vehicles.

Exclusive to Federal Signal, these innovative technologies help provide work zone safety. Ask your local FS Representative how you can experience the latest Federal Signal products.

TECHNOLOGY

Federal Signal Exclusive Technologies



SPECTRALUX® multicolor LED technology provides the ability for a LED light head to change color while in operation. LEDs can change between Red, Blue, Amber or White through user-selected flash patterns.



SOLARIS® LED reflector technology is engineered to increase off-axis warning and maximize the LED light source to eliminate dark spots and distribute 360-degrees of light coverage.



SLR (SOLARIS® LED ROTATOR) maximizes the LED light source for full light coverage. The SLR rotates the Solaris LED reflector providing superior LED warning light output.



FS CONVERGENCE NETWORK provides “plug-n-play” installation with Federal Signal’s SmartSiren® Platinum, amplifier and controller, to our family of serial communication light bars and SpectraLux ILS interior lighting system.



ROC (RELIABLE ONBOARD CIRCUITRY™) technology eliminates approximately 85% of the connection failure points found in a typical light bar. Wires, connections and assemblies are replaced by PCB assemblies — reducing labor repair time and increasing the road time for emergency vehicles.



HOTFOOT® lighted mounting feet provide additional light through powerful Solaris LED reflectors that are built into the mounting system of the light bar.



FSLink™ is a built-in software technology that allows LED perimeter lights, interior lights and beacons to synchronize their flash patterns for a unified vehicle warning solution.

Light bars	
Light bar Features Comparison	4
Navigator®	5-7
Vision® SLR - NFPA	8
Split Vision® SLR	9
Three-Pod Vision® SLR	9
Allegiant™ Serial	10
Legend® LPX Discrete	11
Legend®	12
Integrity®	13
Valor®	14
HighLighter™ Features Comparison	15
HighLighter™ LED	15
HighLighter™ LED Plus	16
HighLighter™ LED Pro	16
Light bar Replacement Parts	17-18
Hook Mount Reference Guide	19
Sirens / Speakers	
Siren/Speaker Features Comparison	20
Q-Siren®	21
Electronic Q-Siren® (e-Q2B®)	21
SmartSiren® Platinum 3000	22
SmartSiren® Platinum 2000	23
650 Series	24
PA640	24
Rumbler®	25
PA300	26
PA4000	26
TS100-N	27
AS124	27
BP Series	28
DynaMax®/ES100C	29
Exterior Perimeter Lights	
Perimeter Light Features Comparison	30
FireRay® LED	31-34
Perimeter Light Programmer	34
QuadraFlare®	35-38
Impaxx®	39
Exterior Perimeter Light Brackets	40-41
MicroPulse® Ultra	42
MicroPulse®	43
MicroPulse® C Series	43
MicroPulse® Wide Angle	44
MicroPulse® Flashing/Marker	44
MicroPulse® Series Brackets	45-46
Latitude™ Flashing Models	47
Corner LED Features Comparison	48
In-Line Corner LED System (416200)	48
416300 Series	49
Corner LED System (416900/416910)	49
Commander® Flashing and Marker Lights	50
Commander® 3" Flashing and Compartment Lights	50
SignalTech® LED Lights	51
Interior Mount Warning Lights	
Interior Mount Light Features Comparison	52
SpectraLux® ILS Low-profile	53-54
XStream™	55
Beacons	
Beacon Features Comparison	56
SLR Beacon	57
IVP SLR	57
LP800	58
Pro LED Beacon	58
Directional Warning Lights	
Directional Warning Features Comparison	59
CN SignalMaster™	60-61
Latitude™ SignalMaster™	62
VPX SignalMaster™	63
Escape 72" SignalMaster™	63
SignalMaster™ Controllers	63
Area Lighting	
Commander® Series	64
Commander® Plus & Plus-S Series	65
Commander® M Series	66
Commander® LC Series	66
Commander® SB Series	67
Commander® Series Surface Mount Lights	67
Commander® Series Brow Mounts	68
Commander® Series 550 Work Lights	69
Commander® Series 750/1200 Work Lights	69
Wireless VisiBeam®/VisiBeam®	70
Compartment Lighting	
FireFly Compartment Light	71
Commander® Series Flex Lights	71
Commander® 5" LED Dome Lights	71
Commander® 8" LED Dome Lights	72
Commander® Illumination Lights	72
Commander® 3" Compartment Lights	73
SignalTech Compartment Light	73
Back-up Alarms and Mobile Camera Systems	
Evacuator® Back-up Alarms	74
2012 Series Back-up Alarm	74
Reverse Camera/Monitor Systems	75
Atkinson Dynamics Intercoms	76
Accessories	
FSX Visor Light	77
Headlight/Taillight Flashers	77
MB1 LED Message Board	78
Switch Controls	79
Intelli-Flash® Flashers	79
Opticom®	79
Littlite®	80
Voice Gun	80
AirEL Illuminated Thermal Identification System	81
Limited Warranty	82-83

General Notes

1. All voltage is 12V (V denotes volts) unless marked otherwise. Contact the factory for pricing and availability of 24V models.
2. A copy of the Federal Signal warranty and Terms and Conditions that accompany these products can be found at www.fedsig.com.
3. Most products are available in Amber, Blue, Red and White. Some products are available in Green. Consult product data sheets or contact the factory for more information.
4. Base models of light bars and other configured products are not available without installed options.
5. For detailed information on how to order, consult the product data sheets or contact the factory at 800-264-3578.
6. When installing equipment inside airbag equipped vehicles, the installer must ensure that the equipment is installed only in areas recommended by the vehicle manufacturer.
7. Prices for light bars do not include controls (purchase separately) unless otherwise noted.

Light bar Feature Comparison

	Navigator®	Vision® SLR	Allegiant™ Serial	Legend® LPX Discrete	Legend®	Integrity™	Valor™
Available lengths (inches)	10, 18, 25, 45, 53, 60, 73, 87	46, 53, 60	45, 53, 61, 70	24, 45, 53, 61, 70	24, 45, 53, 61, 70	44, 51	44, 51
Non-Linear / V-Shape		•					•
Low-profile			•	•	•	•	•
LED Colors	Amber, Blue, Green, Red, White	Amber, Blue, Green, Red, White	Amber, Blue, Green, Red, White	Amber, Blue, Green, Red, White	Amber, Blue, Green, Red, White	Amber, Blue, Green, Red, White	Amber, Blue, Green, Red, White
Dome Colors	Amber, Blue, Clear, Red	Amber, Blue, Clear, Green, Red	Amber, Blue, Clear, Gray, Red	Amber, Blue, Clear, Red	Amber, Blue, Clear, Red	Clear	Clear
HotFoot®*		•			•	•	•
LED Takedown and Alleys	•	•	•	•	•	•	•
LED SignalMaster™	•	•	•		•	•	•
LED Flood Lighting	•	•	•			•	•
Dimming	•	•	•		•	•	•
LED Warranty (years)	5	5	5	5	5	5	5
Online Configurator	•	•	•	•	•	•	•
2-Color Capability	•	•	•			•	•
3-Color Capability		•				•	•
Solaris® LED Reflectors	•	•	•	•	•	•	•
ROC (Reliable Onboard Circuitry™)			•	•	•	•	•
FS Convergence Network	•	•	•		•	•	•
SpectraLux® Multicolor LED	•	•	•			•	•
SLR (Solaris® LED Rotator)	•	•					

NOTE

- Go to www.fedsig.com to view flash pattern videos, installation manuals and parts breakdown
- * HotFoot is only available for standard hook mount kits

Navigator®



- Multiple lengths available to fit a variety of fleet applications
- Patented SLR rotator optimizes LEDs for a true 360-degree light output
- Patented Solaris® technology incorporated in SLR and QuadraFlare® modules
- Preconfigured models that meet NFPA 1901 and J845 Class 1, GSA-KKK-A-1822F and CAC Title 13
- Two-color capability with LED colors in Amber, Blue, Green, Red and White
- Flood light feature illuminates the front of the vehicle, and virtually eliminates the need for additional spotlights
- Five-year warranty

Online Light bar Configurator



10" Navigator Models

Model #	Warning Lights	QuadraFlare Stationary Heads	SLR Rotator	White LED Flood Light	Amber LED SignalMaster	White Light Cut-Off	Dome Color	Mirror	Bulkhead Color	Convergence Network/Discrete	Mount	List Price
NVG10D-NFPA21-D	Red	●					Clear			Discrete	Flat	\$660.00
NVG10D-NFPA21-P	Red	●					Clear			Discrete	Flat	660.00
NVG10D-NFPA20	Red	●					Clear			Discrete	Flat	960.00
NVG10D-NFPA22-D	Red		●				Clear	Driver-Side		Discrete	Flat	650.00
NVG10D-NFPA22-P	Red		●				Clear	Passenger-Side		Discrete	Flat	650.00

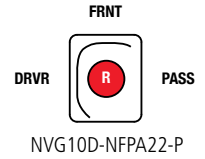
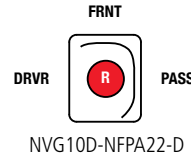
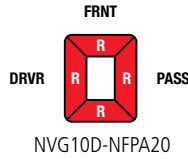
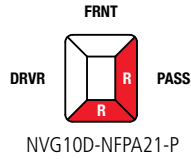
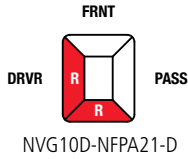

18" Navigator Models

Model #	Warning Lights	QuadraFlare Stationary Heads	SLR Rotator	White LED Flood Light	Amber LED SignalMaster	White Light Cut-Off	Dome Color	Mirror	Bulkhead Color	Convergence Network/Discrete	Mount	List Price
NVG18D-NFPA20-D	Red/White	●				●	Clear		Clear	Discrete	4" Riser	\$1,120.00
NVG18D-NFPA20-P	Red/White	●				●	Clear		Clear	Discrete	4" Riser	1,120.00

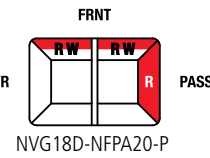
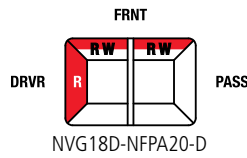

25" Navigator Models

Model #	Warning Lights	QuadraFlare Stationary Heads	SLR Rotator	White LED Flood Light	Amber LED SignalMaster	White Light Cut-Off	Dome Color	Mirror	Bulkhead Color	Convergence Network/Discrete	Mount	List Price
NVG25D-NFPA20-D	Red/White	●				●	Clear		Clear	Discrete	4" Riser	\$1,310.00
NVG25D-NFPA20-P	Red/White	●				●	Clear		Clear	Discrete	4" Riser	1,310.00
NVG25D-NFPA21	Red	●					Clear		Clear	Discrete	4" Riser	1,450.00

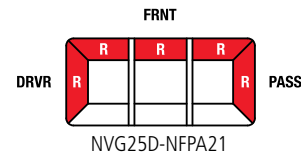
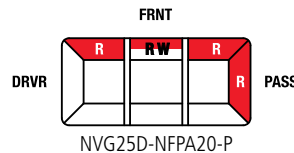
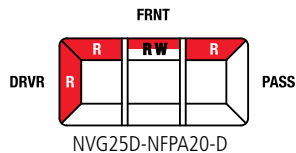

Effective April 1, 2018

45" Navigator Models

Model #	Warning Lights	QuadraFlare Stationary Heads	SLR Rotator	White LED Flood Light	Amber LED SignalMaster	White Light Cut-Off	Dome Color	Mirror	Bulkhead Color	Convergence Network/Discrete	Mount	List Price
NVG45Z-NFPA20	Red/White	●		●	●	●	Clear		Clear	Convergence Network	Hook	\$3,800.00
NVG45Z-NFPA21	Red/White	●	●	●	●	●	Clear	End	Clear	Convergence Network	Hook	3,410.00

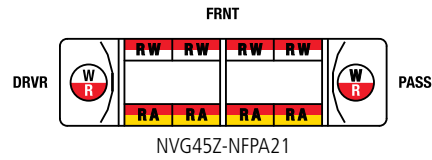
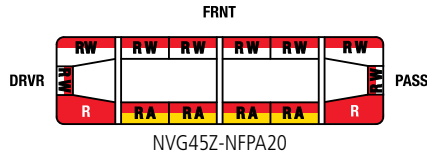

53" Navigator Models

Model #	Warning Lights	QuadraFlare Stationary Heads	SLR Rotator	White LED Flood Light	Amber LED SignalMaster	White Light Cut-Off	Dome Color	Mirror	Bulkhead Color	Convergence Network/Discrete	Mount	List Price
NVG53Z-NFPA20	Red/White	●		●	●	●	Clear		Clear	Convergence Network	Hook	\$4,160.00
NVG53Z-NFPA21	Red/White	●	●	●	●	●	Clear	End	Clear	Convergence Network	Hook	3,850.00

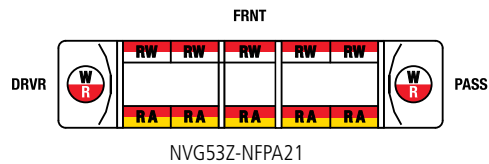
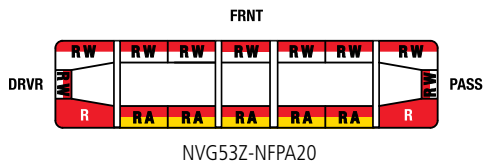

60" Navigator Models

Model #	Warning Lights	QuadraFlare Stationary Heads	SLR Rotator	White LED Flood Light	Amber LED SignalMaster	White Light Cut-Off	Dome Color	Mirror	Bulkhead Color	Convergence Network/Discrete	Mount	List Price
NVG60D-NFPA20	Red/White	●	●			●	Clear	End & Rear-Blocking	Clear	Discrete	4" Riser	\$2,635.00
NVG60D-NFPA21	Red/White	●		●		●	Clear		Clear	Discrete	4" Riser	3,110.00
NVG60D-NFPA22	Red/White	●		●		●	Clear		Clear	Discrete	4" Riser	3,470.00

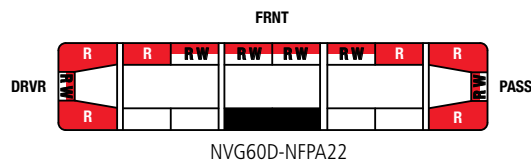
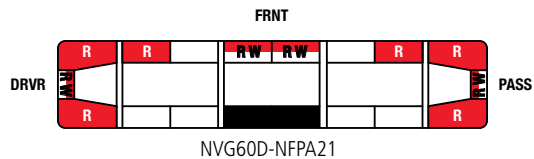
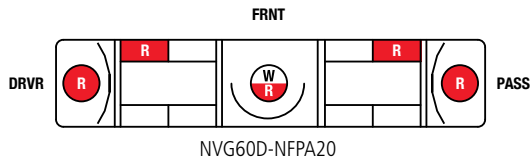

73" Navigator Models

Model #	Warning Lights	QuadraFlare Stationary Heads	SLR Rotator	White LED Flood Light	Alley Lights	Amber LED SignalMaster	White Light Cut-Off	Mirror	Dome Color	Bulkhead Color	Convergence Network/Discrete	Mount	List Price
NVG73D-NFPA20	Red/White	●		●			●		Clear	Clear	Discrete	4" Riser	\$2,670.00
NVG73D-NFPA21	Red/White	●	●	●			●	End & Rear-Blocking	Clear	Clear	Discrete	4" Riser	3,420.00
NVG73D-NFPA22	Red/White		●	●			●	End & Rear-Blocking	Clear	Clear	Discrete	4" Riser	3,400.00
NVG73D-NFPA23	Red	●							Clear	Clear	Discrete	4" Riser	3,310.00
NVG73D-NFPA24	Red/White	●		●			●		Clear	Clear	Discrete	4" Riser	3,470.00

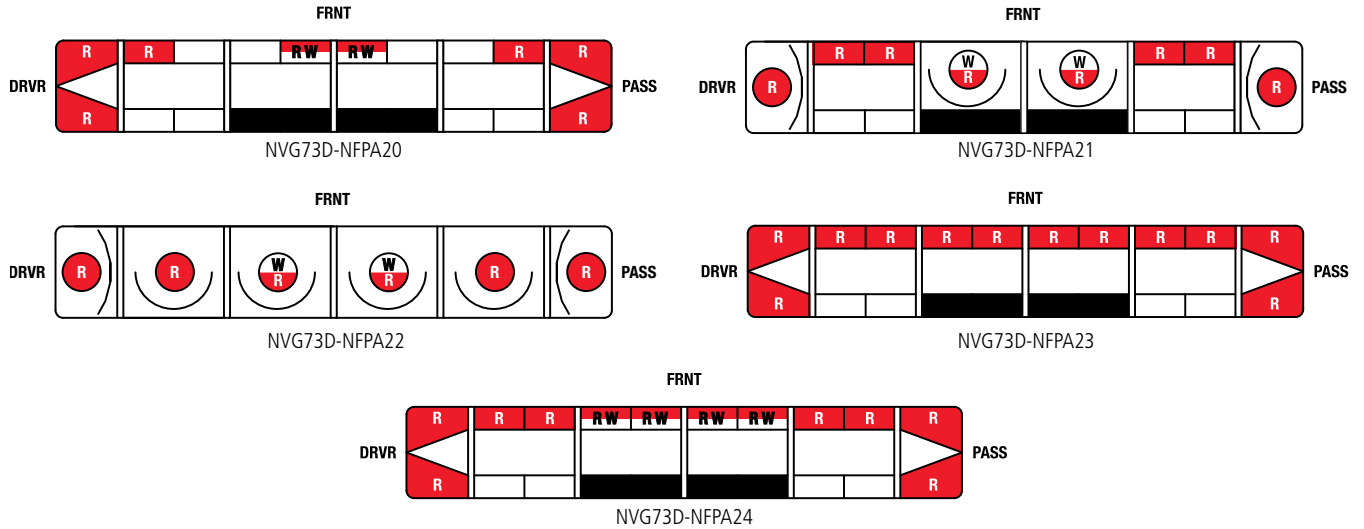

87" Navigator Models

Model #	Warning Lights	QuadraFlare Stationary Heads	SLR Rotator	White LED Flood Light	Alley Lights	Amber LED SignalMaster	White Light Cut-Off	Mirror	Dome Color	Bulkhead Color	Convergence Network/Discrete	Mount	List Price
NVG87D-NFPA20	Red/White	●		●			●		Clear	Clear	Discrete	4" Riser	\$3,100.00
NVG87D-NFPA22	Red/White		●	●			●	End & Rear-Blocking	Clear	Clear	Discrete	4" Riser	3,075.00

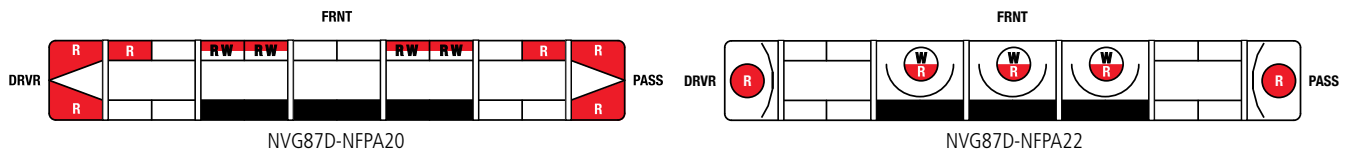

HOW TO ORDER

Choose one of the popular models above, customize your own light bar with our [online configurator](#) or contact a local Federal Signal representative or distributor.

NOTES

- All SLR rotators spin at 90 FPM
- Flood operation may negate NFPA compliance
- Light bar includes choice of permanent or hook-on mount kit. If ordered separately from light bar, list price for HKB hook kit is \$65.00

Effective April 1, 2018

Vision® SLR - NFPA

- SpectraLux® multicolor LED technology available in combinations of Amber, Blue, Green, Red or White
- Solaris® LED reflector technology for better optical efficiency and superior off-axis warning
- FS Convergence Network for “plug-n-play” installation and programming
- Optional LED HotFoot® mounting for LED alley and takedown lights
- Individual pod replacement for easy servicing
- Single color pod LEDs offered in Amber, Blue, Green, Red and White
- Optional LED alley caps
- Available in 46", 53", and 60" lengths
- Five-year warranty



Model #	Length	Warning Lights	Takedown/Alley Lights	White Light Cut-Off	Serial Interface Module	Mount	List Price
VSLR46S-NFPA1	46"	Red/White	Pods 3/5	●	●	Hook	\$3,995.00
VSLR46S-NFPA2	46"	Red/White		●	●	Hook	4,820.00
VSLR46S-NFPA3	46"	Red/White	Pods 3/5	●	●	Hook	3,995.00
VSLR46S-NFPA4	46"	Red/White		●	●	Hook	4,820.00
VSLR53S-NFPA1	53"	Red/White	Pods 3/5	●	●	Hook	4,195.00
VSLR53S-NFPA2	53"	Red/White		●	●	Hook	5,020.00
VSLR53S-NFPA3	53"	Red/White	Pods 3/5	●	●	Hook	4,195.00
VSLR53S-NFPA4	53"	Red/White		●	●	Hook	5,020.00
VSLR60S-NFPA1	60"	Red/White	Pods 3/5	●	●	Hook	4,295.00
VSLR60S-NFPA2	60"	Red/White		●	●	Hook	5,120.00
VSLR60S-NFPA3	60"	Red/White	Pods 3/5	●	●	Hook	4,295.00
VSLR60S-NFPA4	60"	Red/White		●	●	Hook	5,120.00

Accessories and Kits

HKB-Model	Hook, required with hook-on mount, specify vehicle (see page 19)	65.00
795H-EXT-D	795H Opticom in sealed housing with bracket for driver-side mounting	1,999.00
795H-EXT-P	795H Opticom in sealed housing with bracket for passenger-side mounting	1,999.00

NOTE

- Light bar includes choice of permanent or hook-on mount kit. If ordered separately from light bar, list price for HKB hook kit is \$65.00

HOW TO ORDER

Choose one of the popular models above, customize your own light bar with our [online configurator](#) or contact a local Federal Signal representative or distributor.

Online Light bar Configurator

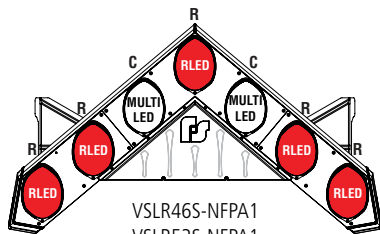

VSLR46S-NFPA1
VSLR53S-NFPA1
VSLR60S-NFPA1

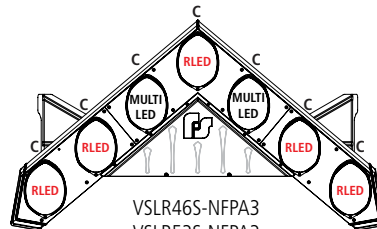

VSLR46S-NFPA3
VSLR53S-NFPA3
VSLR60S-NFPA3

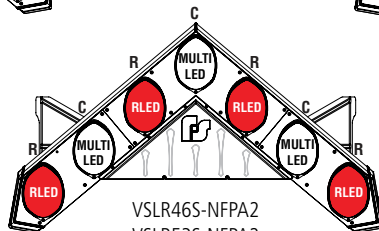

VSLR46S-NFPA2
VSLR53S-NFPA2
VSLR60S-NFPA2

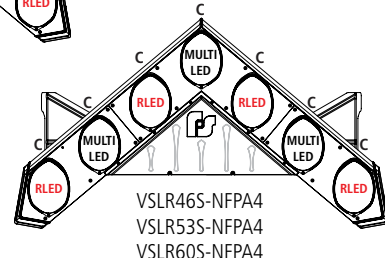

VSLR46S-NFPA4
VSLR53S-NFPA4
VSLR60S-NFPA4

Split Vision® SLR

- Available in six-pod or eight-pod models
- SpectraLux® Multicolor LED technology
- Patented SLR rotator optimizes LEDs for a true 360-degree light output
- Solaris® LED reflector technology for better optical efficiency and superior off-axis warning
- Individual pod replacement for easy service
- May be used as part of NFPA 1901 compliant package
- Five-year warranty



Model #	Pods	Warning Lights	Takedown and Alley Lights	White Light Cut-Off	Discrete	Mount	List Price
VSLR6S-NFPA1	6 pod (3 each side)	Red/White	●	●	●	Permanent	\$3,745.00
VSLR6S-NFPA3	6 pod (3 each side)	Red/White	●	●	●	Permanent	3,745.00
VSLR8S-NFPA1	8 pod (4 each side)	Red/White		●	●	Permanent	4,245.00
VSLR8S-NFPA2	8 pod (4 each side)	Red/White	●	●	●	Permanent	5,095.00
VSLR8S-NFPA3	8 pod (4 each side)	Red/White		●	●	Permanent	4,245.00
VSLR8S-NFPA4	8 pod (4 each side)	Red/White	●	●	●	Permanent	5,095.00

HOW TO ORDER

Choose a popular model above or contact your Federal Signal representative or distributor.

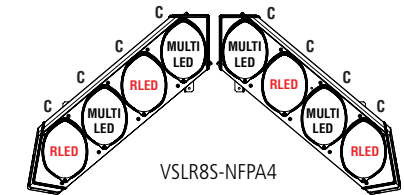
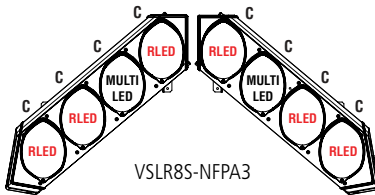
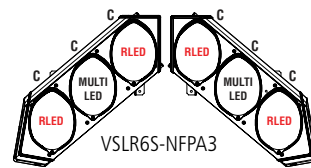
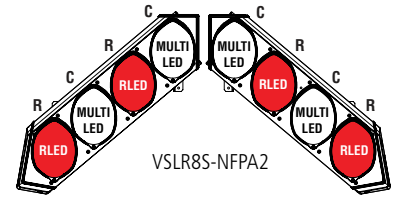
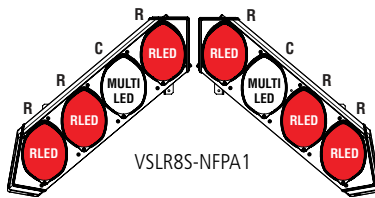
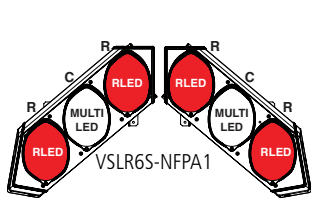

Three-Pod Vision® SLR

- SpectraLux® multicolor LED technology
- Solaris® LED reflector technology for better optical efficiency and superior off-axis warning
- Patented SLR rotator optimizes LEDs for a true 360-degree light output
- Individual pod replacement for easy service
- Five-year warranty



Model #	Warning Lights	Takedown Light	White Light Cut-Off	Discrete	Mount	List Price
VSLR3S-NFPA1	Red/White	●	●	●	Permanent	\$1,928.00
VSLR3S-NFPA3	Red/White	●	●	●	Permanent	1,928.00

HOW TO ORDER

Choose a popular model above or contact your Federal Signal representative or distributor.

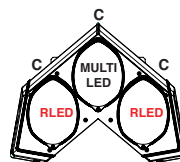
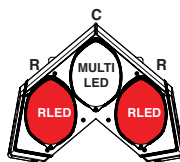

VSLR3S-NFPA1

VSLR3S-NFPA3

Effective April 1, 2018

Allegiant™ Serial



- Low-profile, linear-shaped LED light bar
- Combines effective warning with the tactical benefits of flood lighting capability
- Integrated SignalMaster™ directional capability
- Available in 45", 53", 61", and 70" lengths
- FS Convergence Network, serial light bar
- SpectraLux® multicolor LED technology
- Solaris® LED reflector technology
- ROC (Reliable Onboard Circuitry™) technology
- Five-year warranty



Model #	Length	Warning Lights	Takedown & Alley Lights	White LED Flood Light	Amber LED SignalMaster	Top Dome Color	Mount	Interface Module	List Price
ALGT45-3668634	45"	Red/White	●	●	●	Red	Hook		\$2,200.00
ALGT45-3668676	45"	Red/White	●	●	●	Red	Hook	●	2,285.00
ALGT45-3668688	45"	Red/White	●	●	●	Clear	Hook		2,200.00
ALGT45-3668691	45"	Red/White	●	●	●	Clear	Hook	●	2,285.00
ALGT53-3668640	53"	Red/White	●	●	●	Red/Clear/Red	Hook		2,410.00
ALGT53-3668681	53"	Red/White	●	●	●	Red/Clear/Red	Hook	●	2,495.00
ALGT53-3668697	53"	Red/White	●	●	●	Clear	Hook		2,410.00
ALGT53-3668708	53"	Red/White	●	●	●	Clear	Hook	●	2,495.00

NOTE

• Light bar includes choice of permanent, hook-on, or low-profile hook-on mount kit. If ordered separately from light bar, list price for HKB hook kit is \$65.00

HOW TO ORDER

Choose one of the popular models above, customize your own light bar with our [online configurator](#) or contact a local Federal Signal representative or distributor.

Online Light bar Configurator

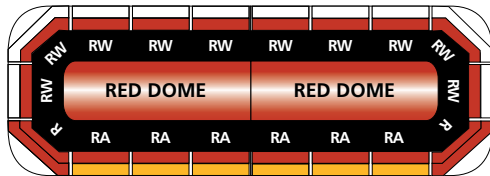

ALGT45-3668634 (without interface module)
ALGT45-3668676 (with interface module)

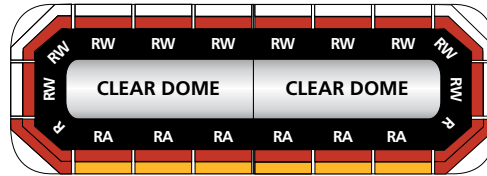

ALGT45-3668688 (without interface module)
ALGT45-3668691 (with interface module)

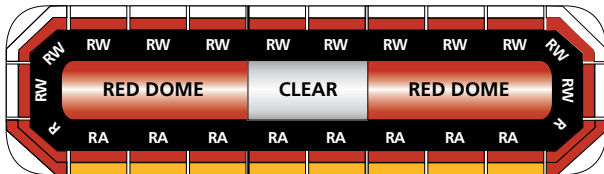

ALGT53-3668640 (without interface module)
ALGT53-3668681 (with interface module)

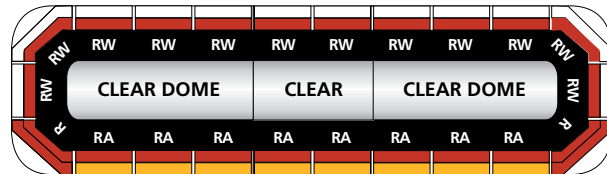

ALGT53-3668697 (without interface module)
ALGT53-3668708 (with interface module)



53" Allegiant light bar, Red LED Warning Lights and White LED Takedowns, all Red top domes

Legend® LPX Discrete

- All-LED light bar - LED work lights and B/T/T lights available
- LEDs offered in Amber, Blue, Green, Red and White
- Top domes offered in Amber, Blue, Clear and Red
- Independently controlled front and rear flashing
- Ten selectable flash patterns; two flashing modes
- Available in 24", 45", 53", 61" and 70" lengths
- Patented ROC (Reliable Onboard Circuitry,™) technology
- Solaris® LED reflector technology for better optical efficiency and superior off-axis warning
- Five-year warranty



Model #	Length	Warning Lights	Takedown Lights	Top Dome Colors	Discrete	Mount	List Price
LPX45D-2656226	45"	Red		Clear	●	Hook	\$1,740.00
LPX45DS-NFPA	45"	Red		Red	●	Hook	1,760.00
LPX53DNC-2656674	53"	Red		Clear	●	Hook	1,900.00
LPX53DNC-2657476	53"	Red	●	Clear	●	Hook	1,900.00
LPX53DS-NFPA	53"	Red	●	Red	●	Hook	1,810.00
LPX61DNC-2657590	61"	Red		Clear	●	Permanent	2,050.00
LPX61DNC-2657643	61"	Red	●	Clear	●	Permanent	2,060.00
LPX61DS-NFPA	61"	Red	●	Red	●	Flat	1,790.00
LPX70DS-NFPA1	70"	Red	●	Red	●	Permanent	1,940.00
LPX70DS-NFPA2	70"	Red	●	Red	●	None	1,920.00

NOTE

• Light bar includes choice of permanent or hook-on mount kit. If ordered separately from light bar, list price for HKB hook kit is \$65.00

HOW TO ORDER

Choose one of the popular models above, customize your own light bar with our [online configurator](#) or contact a local Federal Signal representative or distributor.

Online Light bar Configurator

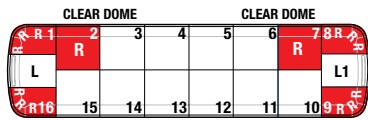

LPX45D-2656226

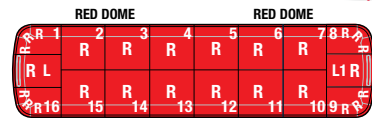

LPX45DS-NFPA

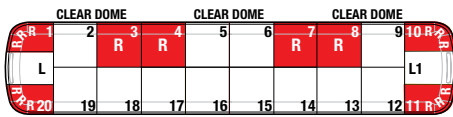

LPX53DNC-2656674



LPX53DNC-2657476

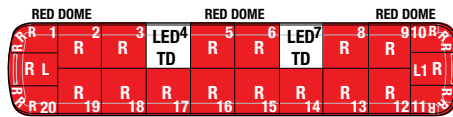

LPX53DS-NFPA



LPX61DNC-2657590

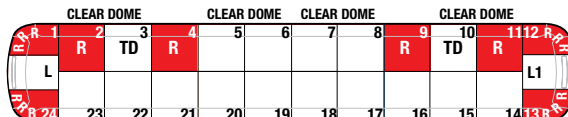

LPX61DNC-2657643

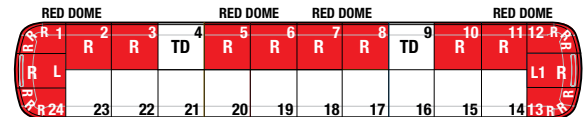

LPX61DS-NFPA



LPX70DS-NFPA1



LPX70DS-NFPA2

Effective April 1, 2018

Legend®

- Ultra bright White LED takedowns and alleys in main bar or HotFoot®
- Light bar can be serviced on the vehicle
- Built-in SignalMaster™ directional warning
- Three or six-button serial controller available for light control only
- Available in 24", 45", 53", 61" and 70" lengths to fit a wide variety of vehicle sizes
- LEDs offered in Amber, Blue, Green, Red and White
- Top covers offered in Amber, Blue, Clear and Red
- Patented ROC (Reliable Onboard Circuitry™) technology
- Solaris® LED reflector technology for better optical efficiency and superior off-axis warning
- FS Convergence Network compatible for "plug-n-play" installation and programming
- Five-year warranty



Model #	Length	Warning Lights	Takedown Lights	Top Dome Colors	Mount	Interface Module	List Price
LGD24Z-2655171	24"	Red/White	●	Clear	Permanent	●	\$819.00
LGD24Z-2655292	24"	Red/White	●	Clear	Permanent	●	819.00
LGD53NFPA-LA1	53"	Red		Clear	Flat		1,950.00
LGD53NFPA-LA2	53"	Red/White	●	Clear	Flat		1,950.00
LGD61NFPA-LA1	61"	Red		Clear	Permanent		2,120.00
LGD61NFPA-LA2	61"	Red/White	●	Clear	Permanent		2,120.00

Accessories and Kits

660000	Six-button programmable controller, light control only	298.00
660300SSG	Three-button programmable controller, light control only	180.00
HKB-(Model)	Hook required with hook-on mount, specify vehicle (see page 19)	65.00

NOTES

- Interface module not needed if light bar is controlled with a SmartSiren Platinum ([see page 22](#))
- Light bar includes choice of permanent or hook-on mount kit. If ordered separately from light bar, list price for HKB hook kit is \$65.00

HOW TO ORDER

Choose one of the popular models above, customize your own light bar with our [online configurator](#) or contact a local Federal Signal representative or distributor.

Online Light bar Configurator

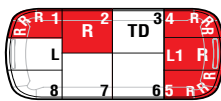

LGD24Z-2655171

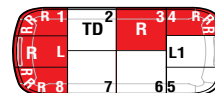

LGD24Z-2655292

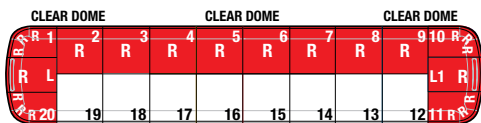

LGD53NFPA-LA1

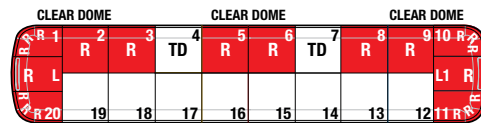

LGD53NFPA-LA2

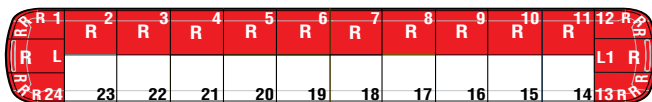

LGD61NFPA-LA1

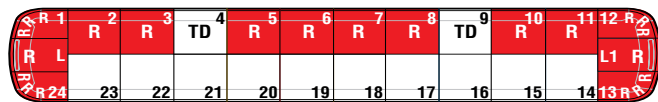

LGD61NFPA-LA2

Effective April 1, 2018

Valor®



- Low profile non-linear LED light bar
- Optional LED HotFoot® mounting for LED alley and takedown lights
- Only 2-inches tall (not including mounts)
- Available in 44" and 51" lengths
- SpectraLux® multicolor LED technology available in combinations of Amber, Blue, Green, Red or White
- Patented ROC (Reliable Onboard Circuitry™) technology
- Solaris® LED reflector technology for better optical efficiency and superior off-axis warning
- FS Convergence Network for "plug-n-play" installation and programming
- Five-year warranty



Model #	Length	Warning Lights	Takedown and Alley Lights	White LED Flood Light	Amber LED SignalMaster	Mount	Interface Module	List Price
VALR44-3651233	44"	Red/White	●		●	Hook	●	\$3,350.00
VALR44-3651242	44"	Red/White	●		●	Hook		3,280.00
VALR44-3651220	44"	Red/White	●	●	●	Hook	●	3,800.00
VALR44-3651229	44"	Red/White	●	●	●	Hook		3,730.00
VALR51-3651258	51"	Red/White	●		●	Hook	●	3,775.00
VALR51-3651217	51"	Red/White	●		●	Hook		3,705.00
VALR51-3651251	51"	Red/White	●	●	●	Hook	●	4,315.00
VALR51-3651249	51"	Red/White	●	●	●	Hook		4,245.00

Accessories and Kits

HKB-Model	Hook required with hook-on mount, specify vehicle (see page 19)	65.00
795H-EXT-D	795H Opticom in sealed housing with bracket for driver-side mounting	1,999.00
795H-EXT-P	795H Opticom in sealed housing with bracket for passenger-side mounting	1,999.00

NOTE

- Light bar includes choice of permanent, hook-on, or low-profile hook-on mount kit. If ordered separately from light bar, list price for HKB hook kit is \$65.00

HOW TO ORDER

Choose one of the popular models above, customize your own light bar with our [online configurator](#) or contact a local Federal Signal representative or distributor.

Online Light bar Configurator

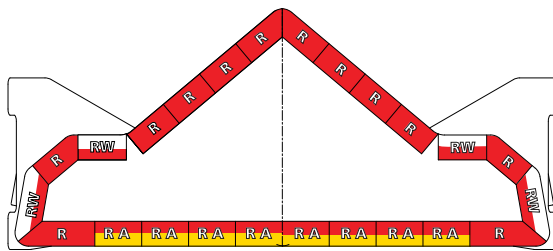

VALR44-3651233 (with interface module)
VALR44-3651242 (without interface module)

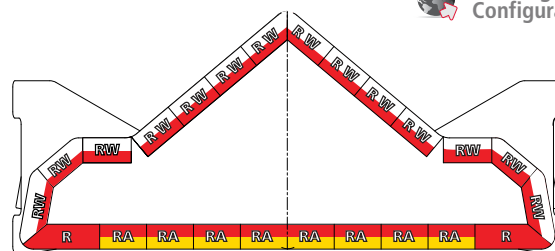

VALR44-3651220 (with interface module)
VALR44-3651229 (without interface module)

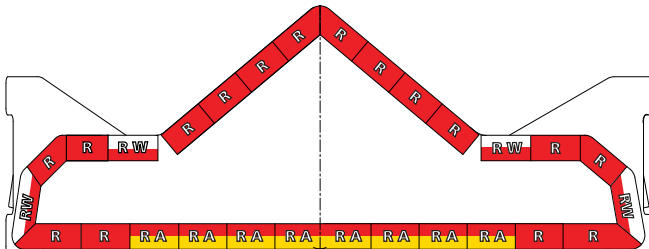

VALR51-3651258 (with interface module)
VALR51-3651217 (without interface module)

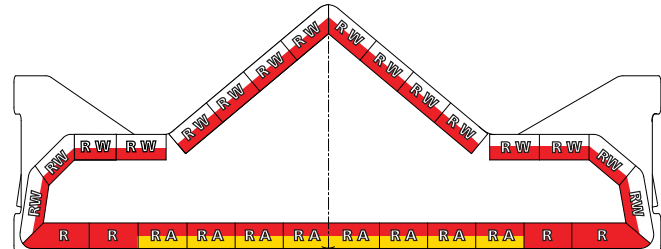



VALR51-3651251 (with interface module)
VALR51-3651249 (without interface module)

HighLighter™ Feature Comparison

	HighLighter LED	HighLighter LED Plus	HighLighter LED Pro
Discrete	•	•	•
Configurated			•
Sync			•
Dimming		•	•
MagnetSelect™	•	•	•
Magnet Included		•	•
LED Count	26	36	up to 42
Solaris® LED Reflectors	•	•	•
ROC (Reliable Onboard Technology™)	•	•	•
LED Warranty (years)	5	5	5

HighLighter Mounting Kits

					
452340 \$55.00	452341 \$74.00	452342 \$33.00	454217 \$62.00	454218 \$38.00	210883SSG \$149.00
Kit, magnetic mount, cigarette plug included	Kit, suction-cup magnetic mount	Kit magnetic mount, cigarette plug not included	Kit, riser mount	Kit, flat mount	Self-leveling bracket

HighLighter™ LED

- Low-profile, only 2.7-inch tall; 15-inch long
- Uniform 360-degree light distribution; no dark spots or shadows
- Pattern selection using MagnetSelect™, key chain not included
- Solaris® LED reflector technology for better optical efficiency and superior off-axis warning
- Patented ROC (Reliable Onboard Circuitry™) technology
- Five-year warranty



Model #	LED Colors	Dome	Mount	Cigarette Plug	List Price
454100HL-02	Amber	Amber	Suction-cup magnet	•	\$345.00
454100HL-25	Amber	Clear	Suction-cup magnet	•	345.00
454100HL-AWA	Amber/White/Amber	Clear	Suction-cup magnet	•	345.00
454101HL-02	Amber	Amber	Permanent		305.00
454101HL-04	Red	Red	Permanent		305.00
454101HL-25	Amber	Clear	Permanent		305.00
454101HL-AWA	Amber/White/Amber	Clear	Permanent		305.00
454101HL-AGA	Amber/Green/Amber	Clear	Permanent		305.00
454102HL-02	Amber	Amber	Magnetic	•	325.00
454102HL-25	Amber	Clear	Magnetic	•	325.00

Accessories and Kits

SW2	Switch control	39.00
Z8560109A	MagnetSelect™ key chain	21.00

Common Replacement Parts

Z8560095B-02	Dome, HighLighter LED, Amber; -03(Blue); -04(Red); -05(Clear)	37.00
Z124161A	Kit, base, HighLighter LED	50.00

Effective April 1, 2018

HighLighter™ LED Plus

- Low-profile, only 2.7-inch tall; 15-inch long
- Uniform 360-degree light distribution; no dark spots or shadows
- Pattern selection using MagnetSelect™, key chain included
- Low power, dim option
- Solaris® LED reflector technology for better optical efficiency and superior off-axis warning
- Patented ROC (Reliable Onboard Circuitry™) technology
- Five-year warranty



Model #	LED Colors	Dome	Mount	Cigarette Plug	List Price
454200HL-02	Amber	Amber	Suction-cup magnet	●	\$510.00
454200HL-03	Blue	Blue	Suction-cup magnet	●	510.00
454200HL-04	Red	Red	Suction-cup magnet	●	510.00
454200HL-05	White	Clear	Suction-cup magnet	●	510.00
454200HL-06	Green	Green	Suction-cup magnet	●	510.00
454200HL-25	Amber	Clear	Suction-cup magnet	●	510.00
454200HL-35	Blue	Clear	Suction-cup magnet	●	510.00
454200HL-45	Red	Clear	Suction-cup magnet	●	510.00
454201HL-02	Amber	Amber	Permanent		470.00
454201HL-03	Blue	Blue	Permanent		470.00
454201HL-04	Red	Red	Permanent		470.00
454201HL-05	White	Clear	Permanent		470.00
454201HL-06	Green	Green	Permanent		470.00
454201HL-25	Amber	Clear	Permanent		470.00
454201HL-35	Blue	Clear	Permanent		470.00
454201HL-45	Red	Clear	Permanent		470.00
454202HL-02	Amber	Amber	Magnetic	●	490.00
454202HL-03	Blue	Blue	Magnetic	●	490.00
454202HL-04	Red	Red	Magnetic	●	490.00
454202HL-05	White	Clear	Magnetic	●	490.00
454202HL-06	Green	Green	Magnetic	●	490.00
454202HL-25	Amber	Clear	Magnetic	●	490.00
454202HL-35	Blue	Clear	Magnetic	●	490.00
454202HL-45	Red	Clear	Magnetic	●	490.00

Accessories and Kits

SW2	Switch control	39.00
Z8560109A	MagnetSelect™ key chain	21.00

Common Replacement Parts

Z8560095B-02	Dome, HighLighter LED, Amber; -03(Blue); -04(Red); -05(Clear)	37.00
Z124161A	Kit, base, HighLighter LED	50.00

HighLighter™ LED Pro

- Low-profile, only 2.7-inch tall; 15-inch long
- Uniform 360-degree light distribution; no dark spots or shadows
- Pattern selection using MagnetSelect™, key chain included
- Low power, dim option
- Sync capability, option
- Two channel high-side flasher synchronizes other light heads (up to 7.5 A per channel), option
- Models can be configured with Amber, Blue, Green, Red or White LEDs
- Solaris® LED reflector technology for better optical efficiency and superior off-axis warning
- Patented ROC (Reliable Onboard Circuitry™) technology
- Five-year warranty



Model #	LED Colors	Dome	Mount	Cigarette Plug	List Price
454301HL-RWR	Red/White/Red	Clear	Permanent		\$570.00
454301HL-RA	Red/Amber	Clear	Permanent		570.00
454301HL-RWA	Red/White/Amber	Clear	Permanent		570.00
454301HL-RRR	Red/Red/Red	Clear	Permanent		570.00

Accessories and Kits

SW2	Switch control	39.00
Z8560109A	MagnetSelect™ key chain	21.00

Common Replacement Parts

Z8560095B-02	Dome, HighLighter LED, Amber; -03 (Blue); -04 (Red); -05 (Clear), -06 (Green)	37.00
Z124161A	Kit, base, HighLighter LED	50.00

Model	Description	List Price
Legend LPX Discrete, Legend LPX and Legend		
660000	6-button programmable controller, Legend	\$298.00
5004355SG	4" riser mount kit, for use up to 61" light bar length	78.00
6603005SG	3-button programmable controller	180.00
Z1751357A-02	RS485, 25-ft Interface cable assembly	37.00
Z1751364B	Cable, Interface, 36"	94.00
Z1751617A	LPX Discrete cable harness	230.00
Z8583020C-01	Gasket, dome, Clear, 6-ft required per base	63.00
Z8583446E	Interface module with cable assembly	73.00
Z864901329	Kit, search light mount	102.00
Z865300732	2" riser mount kit, for use up to 61" light bar length	41.00
Z8653100A	Base, end, Clear	52.00
Z8653101C	Dome, end, Clear; -02(Amber); -03(Blue); -04(Red)	53.00
Z8653101C-GRY	Dome, end, Clear; Gray	129.00
Z8653102A	Base, center, Clear	32.00
Z8653103C	Dome, center, Clear; -02(Amber); -03(Blue); -04(Red)	43.00
Z8653103C-GRY	Dome, center, Clear; Gray	129.00
Z8653134B	Hook mount kit	230.00
Z8653134B-01	Permanent mount kit	230.00
Z8653168A	BP flat mount kit	145.00
Z8653178-2	Flat mount kit, 24" - 61" light bar length	160.00
Z8653178-3	Flat mount kit, 70" light bar length	201.00
Z8653213A-Color	HotFoot replacement	200.00
Navigator Serial and Discrete		
Z1751357A-02	RS485, 25-ft Interface Cable Assembly	37.00
Z806500523A	Dome, end, Clear; -A(Amber), -B(Blue), -R(Red)	88.00
Z806500524A	Middle dome, long, 13.75", Clear; -A(Amber), -B(Blue), -R(Red)	88.00
Z806500525A	Middle dome, short, 7.1", Clear; -A (Amber), -B(Blue), -R(Red)	78.00
Z806500526	Bulkhead, Black; -C (Clear)	40.00
Z806500735	End cap, Clear; -A(Amber), -B(Blue), -R(Red)	78.00
Z806500795-A	6x4 LED QuadraFlare, stationary, single color; -A(Amber), -B(Blue), -R(Red)	233.00
Z806500795-AW	6x4 LED QuadraFlare, stationary, dual color; -AW(Amber/White), -AB(Amber/Blue), -RA(Red/Amber), -RB(Red/Blue), -RW(Red/White), -BW(Blue/White)	263.00
Z806500795-W	6x4 LED QuadraFlare, stationary, single color; -W(White), -G(Green)	263.00
Z806501199-A	7x3 LED QuadraFlare, stationary, single color; -A(Amber), -B(Blue), -R(Red)	206.00
Z806501199-AW	7x3 LED QuadraFlare, stationary, dual color; -AW(Amber/White), -BW(Blue/White), -RB(Red/Blue), -RW(Red/White)	263.00
Z806501199-W	7x3 LED QuadraFlare, stationary, White	206.00
Z806501199-WK	7x3 LED QuadraFlare, stationary, work light	263.00
Z806501313-A	4x3 LED QuadraFlare, stationary, single color; -A(Amber), -B(Blue), -R(Red)	190.00
Z806501313-AW	4x3 LED QuadraFlare, stationary, dual color; -AW(Amber/White), -BW(Blue/White), -RB(Red/Blue), -RW(Red/White)	232.00
Z806501313-W	4x3 LED QuadraFlare, stationary, White	232.00
Z806501337-A	LED SLR Rotator, single color; -A(Amber), -B(Blue), -R(Red)	309.00
Z806501337-AW	LED SLR Rotator, dual color; -AW(Amber/White), -BW(Blue/White), -RB(Red/Blue), -RW(Red/White)	387.00
Z806501337-W	LED SLR Rotator, White	309.00
Z806501522-2	Navigator Series 4" riser mount kit, 10" - 60" light bar length	73.00
Z806501522-4	Navigator Series 4" riser mount kit, 73" - 87" light bar length	83.00
Z8583020C-01	Gasket, dome, Clear, 6-ft required per base	63.00
Z8583446E	Serial Interface Module with Cable Assembly	73.00
Z8623133A-NAV	6-button programmable controller, Navigator	451.00
Z8653134B	Hook mount kit	230.00
Z8653134B-01	Permanent mount kit	230.00
Z8653168A	BP flat mount kit	145.00
Z8653178-1	Flat mount kit, 10" and 18" light bar length	129.00
Z8653178-2	Flat mount kit, 25" - 60" light bar lengths	160.00
Z8653178-3	Flat mount kit, 73" - 87" light bar lengths	201.00





Light Bar Replacement Parts

Federal Signal

Effective April 1, 2018

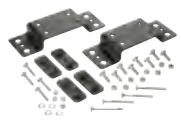
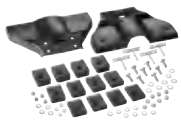
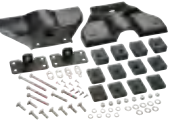
Model	Description	List Price
Integrity		
Z1751357A-02	RS485, 25-ft interface cable assembly	\$37.00
Z2005653A	Controller replacement board	259.00
Z8623133A-VAL	6-button programmable controller, Allegiant/Integrity/Valor	451.00
Z864900652	44" dome service kit	170.00
Z864900653	51" dome service kit	181.00
Z864901329	Kit, search light mount	102.00
Z864901851A	Low-profile hook mount kit	237.00
Z865101904A	Power/ground cable harness	124.00
Z8653134B	Hook mount kit	230.00
Z8653134B-01	Permanent mount kit	230.00
Z8653178-2	Flat mount kit for 44" and 51" light bar lengths	160.00
Z865200637-Color	HotFoot replacement	266.00
Valor		
Z1751357A-02	RS485, 25-ft interface cable assembly	37.00
Z2005653A	Controller replacement board	259.00
Z865100372A	44" dome service kit	223.00
Z865100374A	51" dome service kit	221.00
Z865100870	44"/51" flat mount kit	178.00
Z865101878A	Low-profile hook mount kit	411.00
Z865101904A	Power/ground cable harness	124.00
Z8651116A	Gasket, top dome Valor	41.00
Z8651156A	44" hook mount kit	551.00
Z8651157A	44" permanent mount kit	392.00
Z8651158A	51" hook mount kit	736.00
Z8651159A	51" permanent mount kit	736.00
Z865200637-Color	HotFoot replacement	266.00
Z865201225	Quick disconnect kit	381.00
Allegiant		
500435SSG	4" riser mount kit, for use up to 61" light bar length	78.00
Z1751357A-02	RS485, 25-ft Interface cable assembly	37.00
Z1751364C	Cable, Interface, 36"	94.00
Z8583020C-01	Gasket, dome, Clear, 6-ft required per base	63.00
Z8583446E	Interface module with cable assembly	73.00
Z8623133A-VAL	Replacement 6-button controller, Allegiant/Integrity/Valor	451.00
Z864901329	Kit, search light mount	102.00
Z865300732	2" riser mount kit, for use up to 61" light bar length	41.00
Z8653101C	Dome, end, Clear; -02(Amber); -03(Blue); -04(Red)	53.00
Z8653101C-GRY	Dome, end, Gray	129.00
Z8653103C	Dome, center, Clear; -02(Amber); -03(Blue); -04(Red)	43.00
Z8653103C-GRY	Dome, center, Gray	129.00
Z8653134B	Hook mount kit	230.00
Z8653134B-01	Permanent mount kit	230.00
Z8653178-2	Flat mount kit, 45" - 61" light bar length	160.00
Z8653178-3	Flat mount kit, 70" light bar length	201.00

Light bar Mounting Kits

						
Z8653178-2 \$160.00 Flat Mount	Z8653168A \$145.00 BP Flat Mount	Z8653134B-01 \$230.00 Permanent Mount	Z8653134B \$230.00 Hook Mount	500435SSG \$78.00 4" Riser Mount - Legend Series	Z806501522-2 \$73.00 4" Riser Mount - Navigator Series	Z864901851A \$237.00 Low profile hook mount - Integrity, Legend and Allegiant

For the most up-to-date hook mount information, contact Customer Support at 800-264-3578

Make/Model	Year	Hook Kit Model #	Roof Width	Cab Style
FORD				
C-MAX	2015-17	HKB-LPCHGR11	47.5"	
Edge	2013-14	HKB-CAR8	51.5"	
	2012	HKB-FRD7	52.0"	
Escape	2013-18	HKB-ESC13	52.5"	
Expedition	2003-17	HKB-FTEX	52.0"	
Explorer	2011-18	Permanent Mount	55.0"	
	2008-10	HKB-XPL8	51.0"	
F-150 light bar lengths 44, 45, 46-in	2015-18	HKB-FRD15-44	55.5"	All
	2009-13	HKB-FRD9	57.0"	
F-150 light bar lengths 51, 53-in	2015-18	HKB-FRD15	55.5"	All
	2009-13	HKB-FRD9	57.0"	
F-250/350/450 light bar lengths 44, 45, 46-in	2017-18	HKB-FRD15-44	55.5"	All
	2007-16	HKB-FHD7	58.5"	
F-250/350/450 light bar lengths 51, 53-in	2017-18	HKB-FRD15	55.5"	All
	2007-16	HKB-FHD7	58.5"	
F-550 light bar lengths 44, 45, 46-in	2017-18	HKB-FRD15-44	55.5"	All
	2015-16	HKB-FHD7	55.5"	
F-550 light bar lengths 51, 53-in	2017-18	HKB-FRD15	55.5"	All
	2015-16	HKB-FHD7	55.5"	
Fiesta SE	2013-16	HKB-LPCHGR11	45.0"	
Flex	2012	HKB-LPCHGR11	57.0"	
Focus	2013-17	HKB-LPCHGR11	48.5"	
	2011-12	HKB-CHGR	48.0"	
Fusion	2013-17	HKB-LPCHGR11	46.5"	
	2011-12	HKB-CHGR	48.5"	
Mustang	2012-14	Permanent Mount	46.0"	
Police Interceptor Sedan	2013-18	HKB-TAR11	52.5"	
Police Interceptor Utility - light bar lengths 44,45,46-in (No Rack)	2013-18	HKB-FPIU13-44	55.5"	
		HKB-FPIU13B	55.5"	
Taurus	2011-17	HKB-TAR11	52.5"	
Transit (Low Roof)	2015-17	HKB-LPCHGR11	54.0"	
Transit (Raised Roof)	2015-18	Permanent Mount	NA	
Transit Connect (Low Roof)	2013-17	HKB-TCO11	54.0"	
Van	1987-17	HKB-SAV	65.0"	
Chevrolet/GM				
Avalanche (w/o roof rack only)	2002-13	HKB-CK2	55.0"	Crew
Camaro	2011-14	Permanent Mount	50.0"	
Colorado/Canyon	2015-18	HKB-COL15	47.25"	All
	2007-12	HKB-COL7	45.5"	
Equinox LS (No Roof Rails)	2012-17	HKB-IMP7	48.0"	
Express Van	2003-17	HKB-SAV	61.0"	
Impala (Civilian)	2014-18	HKB-LPCHGR11	49.5"	
	2006-13	HKB-IMP7	46.5"	
Impala Limited & Limited Police	2014-16	HKB-IMP7	46.5"	
	2012-15	HKB-CHGR11	48.0"	
Malibu	2008-11	HKB-MAL8	47.0"	
	2014-18	HKB-TAH15-44	55.75"	All
Silverado/Sierra (1500) light bar lengths 44, 45, 46-in	2007-13	HKB-TA10	55.0"	
	2014-18	HKB-LPCHGR11	55.75"	All
Silverado/Sierra (1500) light bar lengths 51, 53-in	2007-13	HKB-TA10	55.0"	
	2015-18	HKB-TAH15-44	55.0"	All
Silverado/Sierra (2500, 3500) light bar lengths 44, 45, 46-in	2007-14	HKB-TA10	55.0"	
	2015-18	HKB-LPCHGR11	55.0"	All
Silverado/Sierra (2500, 3500) light bar lengths 51, 53-in	2007-14	HKB-TA10	55.0"	
	2012-15	Permanent Mount	43.0"	
Sonic (Sedan or Hatchback)	2015-18	HKB-TAH15-44	55.0"	
Suburban (No Roof Rails) - light bar lengths 44, 45, and 46-in	2007-14	HKB-TA10	55.0"	
	2015-18	HKB-LPCHGR11	55.0"	
Suburban (No Roof Rails) - light bar lengths 51, 53-in	2007-14	HKB-TA10	55.0"	
	2015-18	HKB-TAH15-44	55.0"	
Tahoe - light bar lengths 44, 45, and 46 -in	2007-14	HKB-TA10	55.0"	
	2015-18	HKB-LPCHGR11	55.0"	
Tahoe - light bar lengths 51, 53-in	2007-14	HKB-TA10	55.0"	
	2017	HKB-IMP7	53.0"	
Traverse (No Roof Rails)	2012-16	Permanent Mount	53.0"	
Volt	2012-15	HKB-LPCHGR11	47.0"	

Make/Model	Year	Hook Kit Model #	Roof Width	Cab Style
Chrysler/Dodge/Jeep				
200	2012-14	HKB-FRD4	50.0"	
Challenger	2012-15	Permanent Mount	54.5"	
Charger	2011-18	HKB-LPCHGR11	50.25"	
	2006-10	HKB-CHGR	47.0"	
Durango (No Roof Rack)	2011-18	HKB-MAL7	54.0"	
Grand Caravan/Town & Country	2008-17	HKB-CAR8	60.0"	
Grand Cherokee (No Roof Rack)	2011-17	HKB-MAL7	54.0"	
Liberty	2012	HKB-CAR8	55.0"	
Patriot (No Roof Rails)	2015-17	HKB-FPIU13B	49.0"	
Ram (1500, 2500, 3500)	2010-18	HKB-FRD9	57.5"	All
Wrangler	2012-13	Permanent Mount	N/A	
Nissan				
Leaf	2015-17	HKB-LPCHGR11	N/A	
Subaru				
WRX	2012	HKB-LPCHGR11	47.0"	
International				
Durastar/4300 cab	2002-2016	HKB-FHD7	65.75"	

All Federal Signal light bars may be permanent or hook-on mounted. When using a hook-on mount, a separate hook kit is required for the make, model and year of your vehicle. Use the hook kit reference guide to find your vehicle's appropriate hook kit. Measurements for the roof width are determined by the style of the vehicle. These measurements may help you in choosing the light bar length best suited for your vehicle.

Transfer of light bars from one vehicle to another

From time to time, departments will remove a light bar from an older vehicle and re-install it on a newer vehicle. Before performing this kind of transition, be sure to contact our Service Department to ensure that you not only have the proper hook kit, but that you also have the latest design light bar mount foot. Mounting foot designs continuously improve over time, and it is recommended that you utilize the most current mount foot design when re-installing an older light bar on a newer vehicle.

Notes

The hook kit reference guide is updated on an ongoing basis as information becomes available. Please check the hook kit reference guide online at www.fedsig.com for up-to-date vehicle and hook kit listings. For older vehicle make and model year hook kit offerings, please contact Customer Support at (800) 264-3578. If ordered separate of light bar, hook-on kit costs \$65.00.

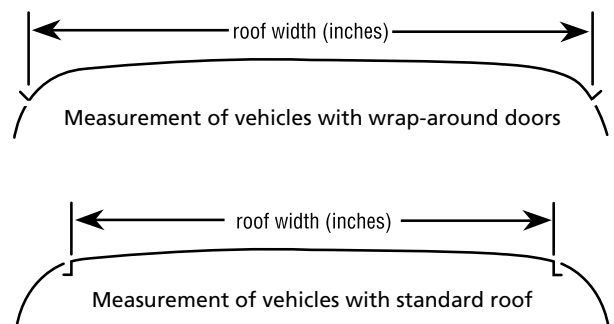

Effective April 1, 2018

Siren Feature Comparison

	Electronic Q-Siren (eQ2b)	SmartSiren SSP3000B	SmartSiren SSP2000B	PA640	650 Series	PA300	MS4000
FS Convergence Network		•	•				
Air Horn	•	•	•	•	•	•	•
PA (Public Address)	•	•	•	•	•	•	
Siren Tones	•	•	•	•	•	•	•
Remote Control Head	•	•	•		•		
Slide Switch		•	•	•			
Lighting Control		•	•	•	•		
SignalMaster™ Control		•	•		•		
Microphone	•	•	•	•	•	•	
Warranty (years)	3	5	3	3	3	3	3
NOTE							
• Go to www.fedsig.com to listen to siren ring tones							

Warning: Sirens and Speakers may produce LOUD sounds necessary to request the right-of-way. Siren and Speakers may cause hearing damage. Wear hearing protection.

Q-Siren®

- Distinct sound provides recognizable long distance warning
- The sound of the Q-Siren is a registered trademark of Federal Signal Corporation
- Utilizes a unique clutch design that provides a longer coast down sound while reducing the Amp draw
- Beautifully streamlined and polished electro-mechanical siren
- Three-year warranty



Siren tones available online

Model	Description	List Price
Q2B-012NNSD	Q2B, mechanical siren, Chrome, recess mount	\$2,194.00
Q2B-012PSD	Q2B, mechanical siren, Chrome, pedestal mount	2,445.00

Kits

Q2FSK	Kit, Q2B, foot switch	49.00
Q-MT	Kit, Q2B, bracket for recess mounting Q2B siren	183.00

Common Replacement Parts

Z8280080B	Motor, Q2B siren	749.00
Z828000641	Clutch assembly	156.00
Z8280104B	Front grille, Q2B siren/BP200-Q	428.00
Z8280106A	Stator guard, Q2B siren	128.00
Z8280B003J-02	Brake assembly	192.00
Z8280C077A	Mounting base, Q2B siren, polished stainless steel	280.00
ZH5205-03	Rear housing, Q2B siren, polished stainless steel	411.00

Electronic Q-Siren® (e-Q2b®)

- Features the traditional trademarked Q-Siren sound
- Available with flush mount or surface mount control head
- Keypad features backlit membrane switches with tactile feel
- Easy-to-read external diagnostics
- Amplifier footprint - (LxHxD) 10.5 in (26.7 cm) x 3.9 in (9.9 cm) x 7.7 in (19.6 cm)
- 200 W power with lower amp draw - 22 A or 100 W
- Features Q-Wail, Yelp, Priority, Air Horn, PA, Radio Re-broadcast and Horn Ring Transfer
- Foot switch inputs
- Three-year warranty



Siren tones available online

Model	Description	List Price
EQ2B-200	200 W, remote amplifier, surface mount control head	\$1,700.00
EQ2B-200FM	200 W, remote amplifier, flush mount control head	1,700.00
EQ2B-100	100 W, remote amplifier, surface mount control head	1,700.00

Common Replacement Parts for EQ units prior to 2011 redesign

Z140417A-04	Connector, male plug, 4-position, EQ2B speaker	21.00
Z140418A-07	Connector, male plug, 7-position, EQ2B control head	22.00
Z140418A-08	Connector, male plug, 8-position, EQ2B control head	27.00
Z140535A	Connector, male plug, 50 A	42.00
Z258B577B-03	Microphone, EQ2B, noise-canceling	75.00
Z8616015A	Control head, EQ2B	451.00
Z8616033B-03	Amplifier, EQ2B, DB9 connector compatible, fits directly in legacy Amp mounting holes	1,750.00

Common Replacement Parts for EQ units newly released in 2011 redesign

Z8616026A	Control head, EQ2B-200, surface mount	900.00
Z8616042A	Control head, EQ2B-200, flush mount	605.00
Z8616033B	Amplifier, EQ2B-200 or EQ2B-200FM	1,663.00
Z258B577B-03	Microphone, EQ2B-200 or EQ2B-200FM	75.00
Z140417A-04	Connector, male plug, 4-position, EQ2B	21.00
Z140535A	Connector, male plug, 50 A	42.00
Z122361A	Air horn switch	37.00

Warning: Sirens and Speakers may produce LOUD sounds necessary to request the right-of-way. Siren and Speakers may cause hearing damage. Wear hearing protection.

Effective April 1, 2018

SmartSiren® Platinum 3000

- Programmable siren/light controller with remote-mount 100/200 W amplifier
- Incorporates FS Convergence Network technology to provide a high level of customizable control capability
- Includes ignition timer functionality
- Four different horn ring transfer functions
- "Plug-n-play" installation and programming software for easy configuration via laptop computer
- Noise-canceling microphone plugs into control head, no need to run mic cable back to amplifier
- Five-year warranty



Siren tones available online



Model	Description	List Price
SSP3000B	100/200 W, programmable, diagnostic and full featured light and siren controller including SignalMaster, microphone included	\$1,699.00
Accessories and Kits		
SWM1	Positions #1, #2 and #3 are inter-dependent to enable "progressive" switching similar to a slide switch function, while position #4 is an independent "push-on/push-off" switch	475.00
SWM2	Positions #1, #2 and #3 are inter-dependent to enable "progressive" switching similar to a slide switch function, while position #4 is an independent "momentary" switch	475.00
Z17500470	Adaptor kit to connect "Series B" controller to previous designed Platinum amplifiers	51.00
ULM20-SSP	Common mic adapter for SmartSiren Platinum	425.00
Z17500471	Adaptor kit to connect "Series B" amplifier to previous designed Platinum amplifiers	82.00
Z853600632A	Control head, SSP3000B	780.00
Z853600629A	Amplifier, SSP3000B	1449.00



Amplifier rear view



SmartSiren programming software gives the ability to clone an entire fleet of remote control head functions



Controller with 17 back-lit push-buttons and 4-position slide switch

Warning: Sirens and Speakers may produce LOUD sounds necessary to request the right-of-way. Siren and Speakers may cause hearing damage. Wear hearing protection.

SmartSiren® Platinum 2000

- Programmable siren/light controller with remote-mount amplifier
- Can control the SignalMaster™ directional functions in Federal Signal light bars, ILS systems, and stick lights with FS Convergence Network
- Six high-side relay outputs and one high/low relay output
- Ten electronic inputs
- Includes ignition timer functionality
- Three-year warranty



Siren tones available online



Model	Description	List Price
SSP2000B-200	100/200 W, programmable, diagnostic and full-featured light and siren controller including SignalMaster, microphone included. Suitable for use with either a single 100 W speaker or a pair of 100 W speakers	\$1,299.00
SSP2000B	100 W, programmable siren/light controller with noise-canceling microphone and eleven solid-state relays	1,275.00

Accessories and Kits

SWM1	Positions #1, #2 and #3 are inter-dependent to enable "progressive" switching similar to a slide switch function, while position #4 is an independent "push-on/push-off" switch	475.00
SWM2	Positions #1, #2 and #3 are inter-dependent to enable "progressive" switching similar to a slide switch function, while position #4 is an independent "momentary" switch	475.00
ULM20-SSP	Common mic adaptor for SmartSiren Platinum	425.00
Z853600632A-SSP2K	Control head, SSP2000B/SSP2000B-200	780.00
Z853600629A-04	Amplifier, SSP2000B	1449.00
Z853600629A-03	Amplifier, SSP2000B-200	1449.00

	SSP2000B	SSP3000B
Siren Tones	Both models feature the same traditional "SmartSiren" and Unitrol tones	
SignalMaster™ Control	Can control the SignalMaster directional functions in Federal Signal light bars, ILS systems, and stick lights that are compatible with the FS Convergence Network	Same as SSP2000B, plus has the capability to control "traditionally-wired" SignalMaster units
Programmable Solid-state Auxiliary Relays	Eleven solid-state relays - One 10 A High/Low - Six 10 A High - Four 2 A High	Fourteen solid-state relays - Ten 10 A High/Low - Four 2 A High
Programmable Input Circuits	Both models have six inputs on the amplifier (park, horn, and 4 additional) Both models also use the same control head which has four additional inputs, commonly used for steering wheel switches	
LED Diagnostic indicators and visual displays	No	Yes
Speakers	SSP2000B - use with 1 speaker SSP2000B-200 - use with 1 or 2 speakers	Use with 1 or 2 speakers
Fuses	Non-illuminating	Illuminating
Compatible with Interceptor Switch Module	Yes	Yes
Timer feature	Yes	Yes
Warranty	3-year	5-year

Warning: Sirens and Speakers may produce LOUD sounds necessary to request the right-of-way. Siren and Speakers may cause hearing damage. Wear hearing protection.

Effective April 1, 2018

650 Series

- Siren/light controller with hand-held control head and integrated microphone
- Ten backlit push-button switches, including progressive, three-position “slide-switch-like” push-buttons
- Wail, Priority, Peak-and-Hold, and Air Horn
- Horn ring transfer
- Remote on/off switch box with built-in PA volume control
- Versatile mounting brackets for amplifier and microphone
- Use with one 100 W speaker
- Three-year warranty



Siren tones available online

Model	Description	List Price
650001	Siren, 650 Series, 100 W, microphone push-button controlled, full-featured, Wail/No Wail tone activation, (8) 10 A relay outputs	\$555.00
650003	Siren, 650 Series, 100 W, microphone push-button controlled, full-featured, Wail-to-Priority tone activation, (8) 10 A relay outputs	565.00
650007	Siren, 650 Series, 100 W, microphone push-button controlled, full-featured, Wail and Yelp tone, (8) 10 A relay outputs, California Title 13 compliant	555.00

Common Replacement Parts

Z146903B	Cable assembly, RJ45, 25-ft	\$27.00
Z8615011A	Amplifier replacement, 100 W, 650001	557.00
Z8615011A-03	Amplifier replacement, 100 W, 650003	748.00
Z8615012A	Bracket, mounting/support, 650001	31.00
Z8615013A	Kit, cable harness	143.00
Z8615014A	Connection box	68.00
Z8615015A	Cable, controller	26.00
Z8615016A	Microphone and controller replacement, 650 Series	214.00
Z8615016A-03	Microphone, controller, 650003	214.00
Z8615017A	Mount, controller	36.00
Z8615018A	Kit, hardware, siren support	15.00
Z8615019A	Kit, connector, relay output	11.00

NOTE

- California Code of Regulations (CCR) Title 13, Article 5 states "Electronic sirens shall have a wail function and may also have manual and yelp functions. No other function is permitted on sirens sold (in CA) after January 1, 1982, except for voice communications"

PA640

- 100 W siren/light controller with PA and microphone
- Internal programmable siren functions
- Four-position progressive slide switch
- Six backlit and rubberized relay push-button switches
- Scrolling Tap II intersection-clearing feature
- Five-year warranty



Siren tones available online

Model	Description	List Price
640000	Siren, 640 Series, 100 W, programmable slide switch and light control	\$656.00

Common Replacement Parts

Z122374A	Slide switch	52.00
Z140338A-11	Connector, 11-position, right angle	30.00
Z141A102	Knob, gain control	7.00
Z141A111	Knob, function/tone selector	16.00
Z258B577D-03	Microphone replacement, 640 Series	101.00
Z8536C1041A	Knob, slide switch, plastic	16.00

NOTE

- California Code of Regulations (CCR) Title 13, Article 5 states "Electronic sirens shall have a wail function and may also have manual and yelp functions. No other function is permitted on sirens sold (in CA) after January 1, 1982, except for voice communications".

Warning: Sirens and Speakers may produce LOUD sounds necessary to request the right-of-way. Siren and Speakers may cause hearing damage. Wear hearing protection.

Rumbler®

- For fire departments with heavy vehicle and pedestrian traffic, where traditional siren systems must compete with a high level of ambient noise, the Rumbler intersection clearing system provides low-frequency warning that significantly increases the ability of the vehicle's siren to get the attention of motorists and pedestrians
- The Rumbler takes the warning tone from the siren and reduces the frequency by 75%, it then amplifies the sound through a pair of high-output woofers
- Requires a siren for tone generation
- Can be used with most Federal Signal 100/200 W sirens and many competitor sirens
- Three-year warranty



Siren tones available online

Model	Description	List Price
RUMBLER-3	Siren Amp, Rumbler, secondary warning system, 12 V, low frequency tones, hardware kit, housing bands and cradles	\$699.00

Accessories and Kits

RB-CHGR15	Kit, pair of mount brackets with hardware for Dodge Charger police package vehicles, 2015-2018	50.00
RB-CRG11	Kit, pair of mount brackets with hardware for 2011-2014, Dodge Charger Police Package vehicles	60.00
RB-DG4500HD	Kit, pair of mount brackets with hardware for Dodge Ram HD, 2010-2012	60.00
RB-DUR15	Kit, pair of mount brackets with hardware for Dodge Durango, 2015-2018	50.00
RB-ES08	Kit, pair of mount brackets with hardware for Ford E-350/450, 2008-2017, and Ford Transit, 2015-2018	60.00
RB-EXPD08	Kit, pair of mount brackets with hardware for Ford Expedition, 2008-2018	60.00
RB-FHD08	Kit, pair of mount brackets with hardware for 2008-2010 Ford F250/F350/F450 vehicles	60.00
RB-FHD11	Kit, pair of mount brackets with hardware for 2011-2015 Ford F250/F350/F450 vehicles	76.00
RB-FHD17	Kit, pair of mount brackets with hardware for 2016-2017 Ford F250/F350/F450/F550 vehicles	50.00
RB-FPIS13	Kit, pair of mount brackets with hardware for Ford Interceptor Sedan, 2012-2018	50.00
RB-FPIU13	Kit, pair of mount brackets with hardware for Ford Police Interceptor Utility, 2013-2015	60.00
RB-FPIU16	Kit, pair of mount brackets with hardware for Ford Police Interceptor Utility, 2016-2018	50.00
RB-FRD15	Kit, pair of mount brackets with hardware for Ford F-150, 2015-2018	50.00
RB-GVAN11	Kit, pair of mount brackets with hardware for Chevrolet Van, any bumper that has a flange on the bottom, 2011-2018	60.00
RB-RAM16	Kit, pair of mount brackets with hardware for Dodge Ram SSV, 2016-2018	50.00
RB-SIL17	Kit, pair of mount brackets with hardware for Chevrolet Silverado SSV, 2015-2018	50.00
RB-SPRNTNTR	Kit, pair of mount brackets with hardware for Sprinter Van only (No cut-away), 2011-2016	60.00
RB-TAH15	Kit, pair of mount brackets with hardware for Chevrolet Tahoe, 2015-2018	50.00
RB-TAHO08	Kit, pair of mount brackets with hardware for Chevrolet Tahoe/Suburban vehicles, 2008-2014	60.00

Common Replacement Parts

Z82831070B	Replacement woofer	129.00
Z82831071D	Kit, connector/bracket, Rumbler speaker	119.00
Z82831072A	Rumbler speaker	412.00
Z82831080A	Rumbler body	109.00
ZRUMBLER-2	Amp, RUMBLER-2	650.00
Z82831056A	Rumbler dome	39.00
Z1461809A	Speaker harness	42.00

Rumbler Brackets

	RB-CHGR15 \$50.00		RB-CRG11 \$60.00		RB-DUR15 \$50.00		RB-EXPD08 \$60.00
	RB-FPIS13 \$50.00		RB-FPIU13 \$60.00		RB-FPIU16 \$50.00		RB-RAM16 \$50.00
	RB-SIL17 \$50.00		RB-TAH15 \$50.00		RB-TAHO08 \$60.00		RB-FHD08 \$60.00

Warning: Sirens and Speakers may produce LOUD sounds necessary to request the right-of-way. Siren and Speakers may cause hearing damage. Wear hearing protection.

Effective April 1, 2018

PA300

- Compact, self-contained electronic siren
- Wail, Yelp, and High/Low or Priority siren tones
- PA and radio re-broadcast
- 100 W or 200 W models available
- Illuminated non-glare control panel
- Effective TAP II intersection clearing
- Built-in noise-canceling microphone
- Three-year warranty



Siren tones available online

Model	Description	List Price
690000	100 W, PA300-012MSC, hi-lo tone, hard-wired microphone	\$448.00
690002	100 W, PA300-012MSCPTY, priority tone, hard-wired microphone	448.00
690009	200 W, PA300-024MSC, hi-lo tone, hard-wired microphone, 24 V	457.00
690010	200 W, PA300-012MSC, hi-lo tone, hard-wired microphone	457.00

Accessories and Kits

761300	Kit, PA300 Series, adapter cable harness converts to new 690000 PA300 design	25.00
DSM	Kit, PA300 Series, bezel for dash mount	53.00

Common Replacement Parts

Z122377A	Switch, 690 Series, air horn	21.00
Z141A102	Knob, PA300, gain control	7.00
Z141A111	Knob, PA300, function/tone selector	16.00
Z1461360A	Wire harness, 690 Series, 4-ft length, 12 VDC	52.00
Z258B577B-03	Microphone, PA300, use with 690 models	75.00
Z8537561A	Accessory kit, connectors, bracket, hardware	88.00
Z1461388A	Wire harness, 690009, 24 VDC	52.00

PA4000

- 200 W electronic siren
- Flush mount controller with remote amplifier
- Diagnostic feature checks system status
- Noise-canceling microphone included
- Three-year warranty



Siren tones available online

Model	Description	List Price
PA4000	200 W, flush mount control, remote amplifier	\$592.00

Common Replacement Parts

Z146903B	Cable assembly, RJ45, 25-ft	27.00
Z1461029A	Cable assembly, control head	41.00
Z258B577B-02	Microphone, PA4000	78.00
Z85361106A	Control head assembly, PA4000	398.00
Z85361108A	Amplifier assembly, PA4000	743.00

Warning: Sirens and Speakers may produce LOUD sounds necessary to request the right-of-way. Siren and Speakers may cause hearing damage. Wear hearing protection.

TS100-N

- 100 W speaker with bracket
- Features Neodymium driver for increased service life
- Weather-resistant housing
- Sound output meets SAE J1849 and Class A
- Two-year warranty



Model	Description	List Price
TS100-N	Speaker, 100 W, high-output, standard bracket, Class A	\$255.00

Common Replacement Parts

Z8470D118	Projector, molded plastic, TS100-N, Black	32.00
Z8556082C	Kit, speaker head, TS100-N	191.00
Z8556B096A	Cone, 3.25", Black, TS100/TS100-N	32.00
Z8619145A	Driver, TS100-N	217.00

NOTE

- Speakers noted as Class A meet CCR, Title 13, Class A, and SAE J1849 specifications when used with a Class A approved Federal Signal siren amplifier

AS124

- Economical 100 W speaker with composite plastic housing
- Features Neodymium driver for increased service life
- Vehicle-specific mounting brackets available for most commonly-used Fire/EMS vehicles
- Two-year warranty



Model	Description	List Price
750501	Speaker, 100 W, with universal mount bolts and hardware, high output, Class A	\$220.00
750501V	Speaker, 100 W, vertical mounting applications, with universal mounting bolts and hardware, high output, Class A	220.00

Accessories and Kits

750501-04	Mounting bracket, Dodge Charger, 2011-2014 and Ford Interceptor Sedan, 2013-2018, does not include Ecoboost models	48.00
750501-07	Mounting bracket for vertical applications, push bumper	48.00
750501-08	Mounting bracket, Dodge Durango, 2015-2018, does not mount with Rumbler	48.00
750501-09	Mounting bracket, Dodge Charger, 2015-2018	48.00
750501-10	Mounting bracket, Ford Interceptor Utility, 2018	48.00
750501-11	Mounting bracket, Chevrolet Tahoe, 2015-2018, does not work on models with "active shutters"	48.00

Common Replacement Parts

Z8280090A	Driver, AS124	217.00
Z8556120B	Kit, BP100/BP200/AS124, speaker head	191.00
Z8650106A	Housing assembly with labels, AS124	88.00

NOTE

- Speakers noted as Class A meet CCR, Title 13, Class A, and SAE J1849 specifications when used with a Class A approved Federal Signal siren amplifier

AS124 Brackets

750501-04	750501-07	750501-08	750501-09	750501-10	750501-11
\$48.00	\$48.00	\$48.00	\$48.00	\$48.00	\$48.00

Warning: Sirens and Speakers may produce LOUD sounds necessary to request the right-of-way. Siren and Speakers may cause hearing damage. Wear hearing protection.

Effective April 1, 2018

BP Series

BP100

- Features Neodymium driver for increased service life
- Unique design projects sound evenly to the front as well as to the sides of the vehicle
- Black finish helps prevent corrosion and increase service life
- 100 W speaker meets Class A standards when used with any Federal Signal siren

BP200

- 200 W speaker features Neodymium driver for increased service life
- Designed to be attractively recess-mounted through the bumper of a vehicle
- Available with the stainless steel Electric "F" grille or the traditional Chrome Q-Siren® grille
- Sound output meets SAE J1849 and Class A
- BP200 - (WxHxD) 7.7 in (19.6 cm) x 5.7 in (14.5 cm) x 4.5 in (11.4 cm) / 6.5 lbs.
- Two-year warranty



BP100



BP200-EF

Model	Description	List Price
BP100	100 W, Black	\$525.00
BP200-EF	200 W, Stainless steel Electric "F" grille, recess mount	759.00
BP200-Q	200 W, Chrome Q-Siren grille, recess mount	1,035.00
Accessories and Kits		
BPMT	Kit, universal bumper mount	65.00
BPFMT-EF	Recess mount, stainless steel Electric "F" grille	74.00
Common Replacement Parts		
Z8280090A	Driver, 100 W, neomagnet	217.00
Z8280104B	Front grille, Q2B siren/BP200-Q, Chrome-plated Q-Siren emblem	428.00
Z8556120B	Kit, BP100/BP200/AS124, speaker head	191.00
Z8567102A	Grille, MSFMT-EF/BP200-EF, stainless steel Electric "F"	33.00
Z8567144A	Standoff, Z8280090A required when replacing old style driver	16.00
Z1751082A	Wire harness, BP200	82.00

NOTE

- Speakers noted as Class A meet CCR, Title 13, Class A, and SAE J1849 specifications when used with a Class A approved Federal Signal siren amplifier

Warning: Sirens and Speakers may produce LOUD sounds necessary to request the right-of-way. Siren and Speakers may cause hearing damage. Wear hearing protection.

DynaMax®/ES100C



- Slim and light-weight compact 100 W speaker
- Features Neodymium driver for increased service life
- Composite plastic housing
- Vehicle-specific mounting brackets available for most commonly-used Fire/EMS vehicles
- Two-year warranty

Model	Description	List Price
ES100C	Speaker, DynaMax/ES100C, 100 W, high output, compact, Class A	\$305.00
ES100C-DEU	Speaker, DynaMax/ES100C, 100 W, high output, compact, Class A, with Deutsch connector	320.00
Accessories and Kits		
ESFMT-EF	Recess mount, stainless steel Electric "F" grille	74.00
ESBMT-SB	Bumper/surface mount bracket	56.00
ESB-U	Universal bail bracket, all vehicles	40.00
ESB-12FHDC	Ford F-250/350 center mount	50.00
ESB-FRD15	Ford F-150, 2015-2018, does not work with Ecoboost models	40.00
ESB-12RAMHD	Dodge Ram HD bumper mount	40.00
ESB-DUR15	Kit, combination bracket for mounting a DynaMax/ES100C and (2) IPX/MPS lights behind grille, Dodge Durango, 2015-2018	40.00
ESB-TAH08	Chevrolet Tahoe, 2003-2014	50.00
ESB-TAH15	Chevrolet Tahoe, 2015-2018 and Silverado SSV, 2015-2018	40.00
ESB-EXP07	Ford Expedition, 2007-2008 and 2013-2018 Ford Police Interceptor Utility including Ecoboost models	40.00
ESB-FPIU16	Kit, combination bracket for mounting a DynaMax/ES100C and (2) IPX/MPS lights behind the grille, Ford Police Interceptor Utility, not including Ecoboost models, 2016-2018	40.00
ESB-FPIUND	Kit, combination bracket for mounting a DynaMax/ES100C and (2) IPX/MPS lights behind grille utilizing pre-drilled holes, Ford Police Interceptor Utility 2016-2018	40.00
ESB-FTH-D	Ford Transit, 2015-2018, housing with Electric "F" Grille, driver side only	139.00
ESB-FTH-P	Ford Transit, 2015-2018, housing with Electric "F" Grille, passenger side only	139.00
ESB-SPRNTR-D	All Sprinter chassis, drivers side only	120.00
ESB-SPRNTR-P	All Sprinter chassis, passengers side only	120.00
ESB-TRAV16ND	Kit, Combination bracket for mounting a DynaMax/ES100C and (2) IPX/MPS lights behind grille utilizing the pre-drilled holes, Chevy Traverse 2016-2018	40.00
ESBL-FUSN16ND	Kit, combination bracket for mounting a DynaMax/ES100C and (2) IPX600/IPX300/MPS600/MPS600U/MPS1200U/MPSW9 lights in grille of 2016+ Ford Fusion	40.00
ESBL-RAM16	Kit, combination bracket for mounting ES100C and (2) IPX300/IPX600/MPS600/MPS600U/MPS1200U/MPS1200U/MPSW9 lights in the upper grille utilizing the pre-drilled holes, will not work with Dodge Ram models that have active shutter grille vents, Dodge Ram SSV, 2016-2018	40.00
ESBL-SIL17ND	Kit, combination bracket for mounting a DynaMax/ES100C and (2) IPX600B/IPX300/MPS600/MPS600U/MPS1200U/MPSW9 lights in the grille of the 2015-2018 Chevrolet Silverado, can be used with 2017 shutters	40.00
ESBL-TAH17ND	Kit, combination bracket for mounting DynaMax/ES100C and (2) IPX300/IPX600B/MPS600/MPS600U/MPS1200U/MPSW9 lights in the grille of the Chevrolet Tahoe PPV, 2018	40.00
Kits - Vehicle Specific Models - Includes (2) ES100C speakers and mounting brackets		
ES100-SPRNTR	Includes (2) ES100C and (1) ESB-SPRNTR, Sprinter 2013-2018	850.00
ES100-TERRA	Includes (2) ES100C and (2) ESB-TERRA, International Terrastar 2010-2015	688.00
ES100-ESFMT-EF	Includes (2) ES100C and (2) ESFMT-EF, Kenworth, GM Van, Ford F-650, E-350/450	688.00
ES100-12FEVN	Includes (2) ES100C and (2) ESB-12FEVN, E-350/450 (behind grille mount)	688.00
ES100-12FHDC	Includes (2) ES100C and (2) ESB-12FHDC, F-Series Heavy Duty 2012+ (center mount)	688.00
ES100-12RAMHD	Includes (2) ES100C and (2) ESB-12RAMHD	808.00
ES100-TAH08	Includes (2) ES100C and (2) ESB-TAH08	688.00
ES100-FTH	Includes (1) ES100C, (1) ESB-FTH-D and (1) ESB-FTH-P, Ford Transit 2015-2018	888.00

NOTE

- Speakers noted as Class A meet CCR, Title 13, Class A, and SAE J1849 specifications when used with a Class A approved Federal Signal siren amplifier

DynaMax ES100C Brackets							
ESB-FRD15 \$40.00	ESFMT-EF \$74.00	ESB-U \$40.00	ESB-DUR15 \$40.00	ESB-TAH08 \$50.00	ESB-TAH15 \$40.00	ESB-EXP07 \$40.00	ESB-FPIU16 \$40.00
ESB-FPIUND \$40.00	ESB-FTH-D \$139.00	ESB-FTH-P \$139.00	ESBL-RAM16 \$40.00	ESBL-SIL17ND \$40.00	ESBL-TAH17ND \$40.00	ESB-TRAV16ND \$40.00	

Warning: Sirens and Speakers may produce LOUD sounds necessary to request the right-of-way. Siren and Speakers may cause hearing damage. Wear hearing protection.

Effective April 1, 2018

Exterior Perimeter Light Feature Comparison

	QuadraFlare®	FireRay® LED	IMPAXX®		MicroPulse®							
			IPX3	IPX6	MPS300U	MPS600U	MPS620U	MPS1200U	MPS1220U	MPSW6	C-Series	MPSW9
Solaris® LED Reflector Technology	•		•	•								
SpectraLux® Multicolor LED Technology				•								
Single color	•	•	•	•	•	•		•		•	•	•
Multicolor				•			•		•			•
Split color	•	•				•		•		•	•	
Number of LEDs*	8,10,12,16	12,24,36	3	6, 12, 18	3	6	12	12	24	6	9, 18	9, 12
Sync Flashing Capability	•	•	•	•	•	•	•	•	•	•	•	•
Clear lens Availability	•	•	•	•	•	•	•	•	•	•	•	•
Color lens Availability	•	•	•		•	•		•				
Warranty (years)	5	5	5	5	3	3	3	3	3	3	3	3

*Number of LEDs determined by color combination and model

FireRay® LED 9x7

- Single and split color models are available
- LEDs offered in Amber, Blue, Green, Red or White
- Lenses offered in Amber, Blue, Clear, Green, or Red
- Available with built-in flasher featuring (13) selectable patterns and (4) flashing modes
- Scene, Brake/Tail/Turn, Turn Arrow and Back-up light models available
- Five-year warranty



FR9C-RW



FR9-R with optional Chrome bezel (FR9MC)

Model	Description	List Price
9x7 Warning lights with Color lens and built-in flasher		
FR9-R	FireRay 900 Series, Red lens, Red LED	\$325.00
FR9-B	FireRay 900 Series, Blue lens, Blue LED	325.00
FR9-A	FireRay 900 Series, Amber lens, Amber LED	325.00
FR9-G	FireRay 900 Series, Green lens, Green LED	345.00
9x7 Warning lights with Clear lens and built-in flasher		
FR9C-R	FireRay 900 Series, Clear lens, Red LED	325.00
FR9C-B	FireRay 900 Series, Clear lens, Blue LED	325.00
FR9C-A	FireRay 900 Series, Clear lens, Amber LED	325.00
FR9C-W	FireRay 900 Series, Clear lens, White LED	325.00
FR9C-G	FireRay 900 Series, Clear lens, Green LED	345.00
9x7 Split-LED Warning lights with Clear lens and built-in flasher		
FR9C-RW	FireRay 900 Series, Clear lens, Red/White split	325.00
FR9C-RB	FireRay 900 Series, Clear lens, Red/Blue split	325.00
FR9C-RA	FireRay 900 Series, Clear lens, Red/Amber split	325.00
FR9C-BA	FireRay 900 Series, Clear lens, Blue/Amber split	325.00
FR9C-BW	FireRay 900 Series, Clear lens, Blue/White split	325.00
FR9C-AW	FireRay 900 Series, Clear lens, Amber/White split	325.00
9x7 Scene light		
FR9LEDCENE	FireRay 900 Series, Scene light, Clear lens	525.00
9x7 Brake/Tail/Turn and Back-up lights		
FR9-BTT	FireRay 900 Series, Brake/Tail/Turn, Red lens, Red LED	354.00
FR9C-BTT	FireRay 900 Series, Brake/Tail/Turn, Clear lens, Red LED	354.00
FR9-BACKUP	FireRay 900 Series, Back-up, Clear lens, White LED	411.00
FR9-ARROW	FireRay 900 Series, Arrow, Amber lens, Amber LED	390.00
FR9C-ARROW	FireRay 900 Series, Arrow, Clear lens, Amber LED	390.00
Accessories and Kits		
FR9MC	Trim bezel, Chrome	20.00
FR9MB	Trim bezel, Black	20.00
FR9MCSCENE	Trim bezel, Scene light, Chrome	20.00
FR9MBSCENE	Trim bezel, Scene light, Black	20.00
FR9-A4HMC	Mounting kit to convert FireRay 9x7 to fit in QuadraFlare 9x7 mounting holes	55.00



FireRay LED 9x7 (FR9C-R) mounted on side and rear of fire engine

Effective April 1, 2018

FireRay® LED 7x3

- Single and split color models are available
- LEDs offered in Amber, Blue, Green, Red or White
- Lenses offered in Amber, Blue, Clear, Green or Red
- Available with built-in flasher featuring (13) selectable patterns and (4) flashing modes
- Five-year warranty



FR7C-RA



FR7-R with optional Chrome bezel (FR7MC)

Model	Description	List Price
7x3 Warning lights with Color lens and built-in flasher		
FR7-R	FireRay 700 Series, Red lens, Red LED	\$215.00
FR7-B	FireRay 700 Series, Blue lens, Blue LED	215.00
FR7-A	FireRay 700 Series, Amber lens, Amber LED	215.00
FR7-G	FireRay 700 Series, Green lens, Green LED	235.00
7x3 Warning lights with Clear lens and built-in flasher		
FR7C-R	FireRay 700 Series, Clear lens, Red LED	215.00
FR7C-B	FireRay 700 Series, Clear lens, Blue LED	215.00
FR7C-A	FireRay 700 Series, Clear lens, Amber LED	215.00
FR7C-W	FireRay 700 Series, Clear lens, White LED	215.00
7x3 Split-LED Warning lights with Clear lens and built-in flasher		
FR7C-RW	FireRay 700 Series, Clear lens, Red/White split	215.00
FR7C-BW	FireRay 700 Series, Clear lens, Blue/White split	215.00
FR7C-AW	FireRay 700 Series, Clear lens, Amber/White split	215.00
FR7C-RB	FireRay 700 Series, Clear lens, Red/Blue split	215.00
FR7C-RA	FireRay 700 Series, Clear lens, Red/Amber split	215.00
FR7C-BA	FireRay 700 Series, Clear lens, Blue/Amber split	215.00
7x3 Scene light		
FR7LEDSCENE	FireRay 700 Series, Scene light, Clear lens	370.00
Accessories and Kits		
FR7MC	Trim bezel, Chrome	20.00
FR7MB	Trim bezel, Black	20.00
FR7-A4HMC	Mounting kit to convert FireRay 7x3 to fit in QuadraFlare 7x3 mounting holes	45.00

FireRay® LED 6x4

- Single and split color models are available
- LEDs offered in Amber, Blue, Green, Red or White
- Lenses offered in Amber, Blue, Clear, Green or Red
- Available with built-in flasher featuring (13) selectable patterns and (4) flashing modes
- Scene, Brake/Tail/Turn, Turn Arrow and Back-up light models also available
- Five-year warranty



FR6C-RW with optional Black bezel (FR6MB)



FR6-R with optional Chrome bezel (FR6MC)

Model	Description	List Price
6x4 Warning lights with Color lens and built-in flasher		
FR6-R	FireRay 600 Series, Red lens, Red LED	\$217.00
FR6-B	FireRay 600 Series, Blue lens, Blue LED	217.00
FR6-A	FireRay 600 Series, Amber lens, Amber LED	217.00
FR6-G	FireRay 600 Series, Green lens, Green LED	237.00
6x4 Warning lights with Clear lens and built-in flasher		
FR6C-R	FireRay 600 Series, Clear lens, Red LED	217.00
FR6C-B	FireRay 600 Series, Clear lens, Blue LED	217.00
FR6C-A	FireRay 600 Series, Clear lens, Amber LED	217.00
FR6C-W	FireRay 600 Series, Clear lens, White LED	217.00
6x4 Split-LED Warning lights with Clear lens and built-in flasher		
FR6C-RW	FireRay 600 Series, Clear lens, Red/White split	217.00
FR6C-BW	FireRay 600 Series, Clear lens, Blue/White split	217.00
FR6C-AW	FireRay 600 Series, Clear lens, Amber/White split	217.00
FR6C-RB	FireRay 600 Series, Clear lens, Red/Blue split	217.00
FR6C-RA	FireRay 600 Series, Clear lens, Red/Amber split	217.00
FR6C-BA	FireRay 600 Series, Clear lens, Blue/Amber split	217.00
6x4 Scene light		
FR6LEDCENE	FireRay 600 Series, Scene light, Clear lens	370.00
6x4 Brake/Tail/Turn and Back-up lights		
FR6-BACKUP	FireRay 600 Series, Back-up light, Clear lens, White LED	211.00
FR6-BTT	FireRay 600 Series, Brake/Tail/Turn, Red lens, Red LED	158.00
FR6C-BTT	FireRay 600 Series, Brake/Tail/Turn, Clear lens, Red LED	158.00
FR6-ARROW	FireRay 600 Series, Arrow, Amber lens, Amber LED	145.00
FR6C-ARROW	FireRay 600 Series, Arrow, Clear lens, Amber LED	145.00
Accessories and Kits		
FR6MC	Trim bezel, Chrome	15.00
FR6MB	Trim bezel, Black	15.00
FR6MC4V	4-position vertical casting, Chrome	190.00
FR6MB4V	4-position vertical casting, Black	190.00
FR6MB3V	3-position vertical casting, Black	190.00
FR6MC3V	3-position vertical casting, Chrome	190.00
FR6MHL	Headlight Mount Kit	48.00
FR6-A4HMC	Mounting kit to convert FireRay 6x4 to fit in QuadraFlare 6x4 mounting holes	35.00



FireRay LED 6x4 (FR6C-R) mounted on bumper with two-to-four hole conversion kit (FR6-A4HMC)



FireRay LED 3-position vertical casting with FireRay LED 6x4 brake/tail/turn (FR6-BTT), arrow (FR6-ARROW), and back-up (FR6-BACKUP)



FR6MC4V



FR6-ARROW

Effective April 1, 2018

FireRay® LED 4x3

- Single and split color models are available
- LEDs offered in Amber, Blue, Green, Red or White
- Lenses offered in Amber, Blue, Clear, Green or Red
- Available with built-in flasher featuring (13) selectable patterns and (4) flashing modes
- Five-year warranty



FR4C-RW with optional Chrome bezel (FR4MC)



FR4-R with optional Chrome bezel (FR4MC)

Model	Description	List Price
4x3 Warning lights with Color lens and built-in flasher		
FR4-R	FireRay 400 Series, Red lens, Red LED	\$180.00
FR4-B	FireRay 400 Series, Blue lens, Blue LED	180.00
FR4-A	FireRay 400 Series, Amber lens, Amber LED	180.00
FR4-G	FireRay 400 Series, Green lens, Green LED	200.00
4x3 Warning lights with Clear lens and built-in flasher		
FR4C-R	FireRay 400 Series, Clear lens, Red LED	180.00
FR4C-B	FireRay 400 Series, Clear lens, Blue LED	180.00
FR4C-A	FireRay 400 Series, Clear lens, Amber LED	180.00
FR4C-W	FireRay 400 Series, Clear lens, White LED	180.00
4x3 Split-LED Warning lights with Clear lens and built-in flasher		
FR4C-RW	FireRay 400 Series, Clear lens, Red/White split	180.00
FR4C-BW	FireRay 400 Series, Clear lens, Blue/White split	180.00
FR4C-AW	FireRay 400 Series, Clear lens, Amber/White split	180.00
FR4C-RB	FireRay 400 Series, Clear lens, Red/Blue split	180.00
FR4C-RA	FireRay 400 Series, Clear lens, Red/Amber split	180.00
FR4C-BA	FireRay 400 Series, Clear lens, Blue/Amber split	180.00
Accessories and Kits		
FR4MC	Trim bezel, Chrome	15.00
FR4MB	Trim bezel, Black	15.00
FR4-A4HMC	Mounting kit to convert FireRay 4x3 to fit in QuadraFlare 4x3 mounting holes	30.00

Perimeter Light Programmer

- Allows for quick and easy flash pattern programming for perimeter lights
- Compatible with FireRay® LED, MicroPulse®, QuadraFlare®, 416900/416910 Corner LEDs and XStream™
- Program up to 6 A at once
- LED screen displays flash pattern selection
- LED status indicator lights show when programming is processing and complete
- Two programming modes, auto and manual
- One-year warranty



Model	Description	List Price
PLPR1	Perimeter light programmer	\$75.00
NOTE		
• The Perimeter Light Programmer is NOT compatible with the following: MicroPulse C Series, IMPAXX, SignalTech, 416300 Series, 416400/416410 Series and 416800/41810 Series.		

QuadraFlare® 9x7

- Solaris® LED reflector technology for better optical efficiency and superior off-axis warning
- Meets NFPA and GSA K-spec compliant upper and lower level requirements
- Features unique Quad-X patterns
- Single model offers both "split" and "solid" flashing capabilities
- Available with built-in flasher featuring a variety of OEM friendly selectable patterns
- LEDs offered in Amber, Blue, Green, Red or White
- Optional Chrome-plated trim bezel
- Five-year warranty



QL97C-RW with optional Chrome bezel (QL97MC)



Model	Description	List Price
9x7 Warning lights with Color lens and built-in flasher		
QL97-AA	QuadraFlare 9x7 Series, Amber lens, Amber LED	\$297.00
QL97-BB	QuadraFlare 9x7 Series, Blue lens, Blue LED	297.00
QL97-RR	QuadraFlare 9x7 Series, Red lens, Red LED	297.00
QL97-GG	QuadraFlare 9x7 Series, Green lens, Green LED	382.00
9x7 Warning lights with Clear lens and built-in flasher		
QL97C-AA	QuadraFlare 9x7 Series, Clear lens, Amber LED	297.00
QL97C-BB	QuadraFlare 9x7 Series, Clear lens, Blue LED	297.00
QL97C-RR	QuadraFlare 9x7 Series, Clear lens, Red LED	297.00
QL97C-WW	QuadraFlare 9x7 Series, Clear lens, White LED	343.00
QL97C-GG	QuadraFlare 9x7 Series, Clear lens, Green LED	343.00
9x7 Split color Warning lights with Clear lens and built-in flasher		
QL97C-AW	QuadraFlare 9x7 Series, Clear lens, Amber/White LED split	343.00
QL97C-BA	QuadraFlare 9x7 Series, Clear lens, Blue/Amber LED split	297.00
QL97C-BW	QuadraFlare 9x7 Series, Clear lens, Blue/White LED split	335.00
QL97C-RA	QuadraFlare 9x7 Series, Clear lens, Red/Amber LED split	297.00
QL97C-RB	QuadraFlare 9x7 Series, Clear lens, Red/Blue LED split	297.00
QL97C-RW	QuadraFlare 9x7 Series, Clear lens, Red/White LED split	343.00
QL97C-RG	QuadraFlare 9x7 Series, Clear lens, Red/Green LED split	343.00
9x7 Brake/Tail/Turn and Back-up lights		
QL97-BTT	QuadraFlare 9x7 Series, Brake/Tail/Turn, Red LED, Red lens	308.00
QL97-TURN	QuadraFlare 9x7 Series, Turn light, Amber LED, Amber lens	308.00
QL97-BACKUP	QuadraFlare 9x7 Series, Back-up light, White LED, Clear lens	308.00
QL97-ARROW	QuadraFlare 9x7 Series, Turn arrow, Amber LED, Amber lens	308.00
9x7 Scene Light		
QL97LEDSCENE	QuadraFlare 9x7 Series, Scene Light, White LED, Clear lens, surface mount	411.00
QL97LEDSCENE-D	QuadraFlare 9x7 Series, Scene Light, White LED, Clear lens, surface mount with Deutsch connector	420.00
Accessories and Kits		
QL97MC	Trim bezel, Chrome with gasket	23.00
650205	LED flasher, (2) 10A channels, (10) flash patterns, high-side switching	133.00
650302	LED flasher, (16) channels, 40A total capacity, K-spec compliant	316.00

Effective April 1, 2018

QuadraFlare® 7x3

- Solaris® LED reflector technology for better optical efficiency and superior off-axis warning
- Surpasses NFPA and GSA K-spec compliant upper and lower level requirements
- Offered with built-in flasher featuring a variety of selectable patterns
- Single model offers both “split” and “solid” flashing capabilities
- Industry standard mounting dimensions
- LEDs offered in Amber, Blue, Green, Red or White
- Optional Chrome-plated trim bezel available
- Five-year warranty



QL73C-RW with optional Chrome bezel (QL73MC)



QL73C-RR with optional Chrome bezel (QL73MC)



Model	Description	List Price
7x3 Warning lights with Color lens and built-in flasher		
QL73-AA	QuadraFlare 7x3 Series, Amber lens, Amber LED	\$180.00
QL73-BB	QuadraFlare 7x3 Series, Blue lens, Blue LED	180.00
QL73-RR	QuadraFlare 7x3 Series, Red lens, Red LED	180.00
QL73-GG	QuadraFlare 7x3 Series, Green lens, Green LED	227.00
7x3 Warning lights with Clear lens and built-in flasher		
QL73C-AA	QuadraFlare 7x3 Series, Clear lens, Amber LED	180.00
QL73C-BB	QuadraFlare 7x3 Series, Clear lens, Blue LED	180.00
QL73C-RR	QuadraFlare 7x3 Series, Clear lens, Red LED	180.00
QL73C-GG	QuadraFlare 7x3 Series, Clear lens, Green LED	227.00
QL73C-WW	QuadraFlare 7x3 Series, Clear lens, White LED	216.00
7x3 Split color Warning lights with Clear lens and built-in flasher		
QL73C-AW	QuadraFlare 7x3 Series, Clear lens, Amber/White LED split	250.00
QL73C-BA	QuadraFlare 7x3 Series, Clear lens, Blue/Amber LED split	221.00
QL73C-BW	QuadraFlare 7x3 Series, Clear lens, Blue/White LED split	250.00
QL73C-RA	QuadraFlare 7x3 Series, Clear lens, Red/Amber LED split	221.00
QL73C-RB	QuadraFlare 7x3 Series, Clear lens, Red/Blue LED split	221.00
QL73C-RW	QuadraFlare 7x3 Series, Clear lens, Red/White LED split	250.00
QL73C-RG	QuadraFlare 7x3 Series, Clear lens, Red/Green LED split	250.00
7x3 Scene Light		
QL73LEDSCENE	QuadraFlare 7x3 Series, Clear lens, White LED, surface mount	195.00
Accessories and Kits		
QL73MC	Trim bezel, Chrome with gasket	15.00
650205	LED Flasher, (2) 10 A channels, (10) flash patterns, high-side switching	133.00
650302	LED Flasher, (16) channels, (40) A total capacity, K-spec compliant	316.00

QuadraFlare® 6x4

- Solaris® LED reflector technology for better optical efficiency and superior off-axis warning
- Surpasses NFPA and GSA K-spec compliant upper and lower level requirements
- LEDs available in Amber, Blue, Green, Red or White
- Offered with built-in flasher featuring a variety of selectable patterns
- Single model offers both "split" and "solid" flashing capabilities
- Industry standard mounting dimensions
- Optional Chrome-plated trim bezel
- Brake/Tail/Turn, Turn Arrow and Back-up light models also available
- Five-year warranty



QL64C-RR with optional Chrome bezel (QL64MC)

QL64C-RW with optional Chrome bezel (QL64MC)



Model	Description	List Price
6x4 Warning lights with Color lens and built-in flasher		
QL64-AA	QuadraFlare 6x4 Series, Amber lens, Amber LED	\$180.00
QL64-BB	QuadraFlare 6x4 Series, Blue lens, Blue LED	180.00
QL64-GG	QuadraFlare 6x4 Series, Green lens, Green LED	180.00
QL64-RR	QuadraFlare 6x4 Series, Red lens, Red LED	180.00
6x4 Warning lights with Clear lens and built-in flasher		
QL64C-AA	QuadraFlare 6x4 Series, Clear lens, Amber LED	180.00
QL64C-BB	QuadraFlare 6x4 Series, Clear lens, Blue LED	180.00
QL64C-GG	QuadraFlare 6x4 Series, Clear lens, Green LED	180.00
QL64C-RR	QuadraFlare 6x4 Series, Clear lens, Red LED	180.00
QL64C-WW	QuadraFlare 6x4 Series, Clear lens, White LED	180.00
6x4 Split color Warning lights with Clear lens and built-in flasher		
QL64C-AW	QuadraFlare 6x4 Series, Clear lens, Amber/White LED split	180.00
QL64C-BA	QuadraFlare 6x4 Series, Clear lens, Blue/Amber LED split	180.00
QL64C-BW	QuadraFlare 6x4 Series, Clear lens, Blue/White LED split	180.00
QL64C-RA	QuadraFlare 6x4 Series, Clear lens, Red/Amber LED split	180.00
QL64C-RB	QuadraFlare 6x4 Series, Clear lens, Red/Blue LED split	180.00
QL64C-RW	QuadraFlare 6x4 Series, Clear lens, Red/White LED split	180.00
QL64C-AG	QuadraFlare 6x4 Series, Clear lens, Amber/Green LED split	180.00
QL64C-RG	QuadraFlare 6x4 Series, Clear lens, Red/Green LED split	200.00
6x4 Scene Light		
64LESCENE	QuadraFlare 6x4 Series, Clear lens, White LED, surface mount	366.00
6x4 Brake/Tail/Turn and Back-up lights		
QL64-BTT	QuadraFlare 6x4 Series, Brake/Tail/Turn, Red LED, Red lens	174.00
QL64-ARROW	QuadraFlare 6x4 Series, Turn arrow, Amber LED, Amber lens	169.00
QL64-TURN	QuadraFlare 6x4 Series, Turn light, Amber LED, Amber lens	174.00
QL64-BACKUP	QuadraFlare 6x4 Series, Back-up light, White LED, Clear lens	204.00
6x4 3-Position Vertical Casting		
QL643V-LEFT	Installed QL64-BTT, QL64-ARROW (left facing), QL64-BACKUP	673.00
QL643V-RIGHT	Installed QL64-BTT, QL64-ARROW (right facing), QL64-BACKUP	673.00
QL643V-LED	Installed QL64-BTT, QL64-TURN, QL64-BACKUP	741.00
QL643V	Casting with gasket	190.00
6x4 3-Position Horizontal Casting		
QL643H-LEFT	Installed QL64-BTT, QL64-ARROW (left facing), QL64-BACKUP	673.00
QL643H-RIGHT	Installed QL64-BTT, QL64-ARROW (right facing), QL64-BACKUP	673.00
QL643H-LEDLEFT	Installed QL64-BTT, QL64-TURN, QL64-BACKUP	741.00
QL643H-LEDRGHT	Installed QL64-BTT, QL64-TURN, QL64-BACKUP	741.00
QL643H	Casting with gasket	190.00
6x4 4-Position Vertical Casting		
QL644V-LEFT	Installed QL64-BTT, QL64-ARROW (left facing), QL64-BACKUP, QL64-RR	911.00
QL644V-RIGHT	Installed QL64-BTT, QL64-ARROW (right facing), QL64-BACKUP, QL64-RR	911.00
QL644V-LED	Installed QL64-BTT, QL64-TURN, QL64-BACKUP, QL64-RR	986.00
QL644V	Casting with gasket	249.00
Accessories and Kits		
650205	LED Flasher, (2) 10 A channels, (10) flash patterns, high-side switching	133.00
650302	LED Flasher, (16) channels, (40) A total capacity, K-spec compliant	316.00
QL64MHL	Headlight mount kit	48.00
QL64MC	Trim bezel, Chrome with gasket	15.00



QL644V-LEFT



QL643V-RIGHT



QL643H-RIGHT

Effective April 1, 2018

QuadraFlare® 4x3

- Solaris® LED reflector technology for better optical efficiency and superior off-axis warning
- Enhanced lens design provides outstanding performance to meet various industry lighting specifications
- Offered with built-in flasher featuring a variety of selectable patterns
- Single model offers both "split" and "solid" flashing capabilities
- LEDs offered in Amber, Blue, Green, Red or White
- Optional Chrome-plated trim bezel available
- SAE J845, J595 Class 1; White, Class 2
- Five-year warranty



QL43C-RW with optional Chrome bezel (QL43MC)



Model	Description	List Price
4x3 Warning lights with Color lens and built-in flasher		
QL43-AA	QuadraFlare 4x3 Series, Amber lens, Amber LED	\$180.00
QL43-BB	QuadraFlare 4x3 Series, Blue lens, Blue LED	180.00
QL43-GG	QuadraFlare 4x3 Series, Green lens, Green LED	180.00
QL43-RR	QuadraFlare 4x3 Series, Red lens, Red LED	180.00
4x3 Warning lights with Clear lens and built-in flasher		
QL43C-AA	QuadraFlare 4x3 Series, Clear lens, Amber LED	180.00
QL43C-BB	QuadraFlare 4x3 Series, Clear lens, Blue LED	180.00
QL43C-GG	QuadraFlare 4x3 Series, Clear lens, Green LED	180.00
QL43C-RR	QuadraFlare 4x3 Series, Clear lens, Red LED	180.00
QL43C-WW	QuadraFlare 4x3 Series, Clear lens, White LED	180.00
4x3 Split color Warning lights with Clear lens and built-in flasher		
QL43C-AW	QuadraFlare 4x3 Series, Clear lens, Amber/White LED split	180.00
QL43C-BA	QuadraFlare 4x3 Series, Clear lens, Blue/Amber LED split	180.00
QL43C-BW	QuadraFlare 4x3 Series, Clear lens, Blue/White LED split	180.00
QL43C-RA	QuadraFlare 4x3 Series, Clear lens, Red/Amber LED split	180.00
QL43C-RB	QuadraFlare 4x3 Series, Clear lens, Red/Blue LED split	180.00
QL43C-RW	QuadraFlare 4x3 Series, Clear lens, Red/White LED split	180.00
4x3 Brake/Tail/Turn, Back-up and Turn Lights		
QL43-BACKUP	QuadraFlare 4x3 Series, Back-up light, White LED, Clear lens	160.00
QL43-BTT	QuadraFlare 4x3 Series, Brake/Tail/Turn, Red LED, Red lens	160.00
QL43-TURN	QuadraFlare 4x3 Series, Turn light, Amber LED, Amber lens	160.00
Accessory		
QL43MC	Trim bezel, Chrome with gasket	20.00

IMPAXX® IPX6

- LED warning light with SpectraLux® multicolor LED and Solaris® LED reflector technologies
- Includes Black mounting bezel; Chrome bezel optional
- Models available in single-, dual-, or three-color
- 6-, 12-, or 18-LEDs per light head
- Available in Amber, Blue, Green, Red, or White LEDs
- Prescription lens provides superior off-axis warning for horizontal and vertical mounting applications
- Five-year warranty



IPX600B-R

IPX600B-W



Model	Description	List Price
Single color, Clear off-axis lens, horizontal mount		
IPX600B-A	6-LED light head, Amber	\$167.00
IPX600B-B	6-LED light head, Blue	167.00
IPX600B-G	6-LED light head, Green	229.00
IPX600B-R	6-LED light head, Red	167.00
IPX600B-W	6-LED light head, White	222.00
Dual color, Clear off-axis lens, horizontal mount		
IPX620B-BA	12-LED light head, Blue/Amber	190.00
IPX620B-BR	12-LED light head, Blue/Red	190.00
IPX620B-BW	12-LED light head, Blue/White	190.00
IPX620B-RA	12-LED light head, Red/Amber	190.00
IPX620B-RW	12-LED light head, Red/White	190.00
IPX620B-WA	12-LED light head, White/Amber	190.00
Triple color, Clear off-axis lens, horizontal mount		
IPX630B-BRA	18-LED light head, Blue/Red/Amber	230.00
IPX630B-BRW	18-LED light head, Blue/Red/White	230.00
Triple color, Clear off-axis lens, vertical mount		
IPX633B-BRW	18-LED light head, Blue/Red/White	235.00
Accessory		
IPX6M-1	Chrome bezel, for all IMPAXX 6 models	20.00
Common Replacement Part		
Z8652239A	Black bezel, replacement	9.00

IMPAXX® IPX3

- Three-LED warning light with Solaris® LED reflector technology
- Includes Black mounting bezel; Chrome bezel optional
- Amber, Blue, Green, Red, or White LEDs
- Amber, Blue, Clear or Red lens colors
- Five-year warranty



IPX300-5

IPX302-4
with optional Chrome bezel
Chrome Bezel (IPXM-1)









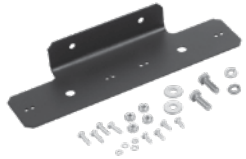

Model	Description	List Price
Single color, Clear off-axis lens		
IPX300-2	3-LED light head, Amber	\$118.00
IPX300-3	3-LED light head, Blue	118.00
IPX300-4	3-LED light head, Red	118.00
IPX300-5	3-LED light head, White	118.00
IPX300-6	3-LED light head, Green	146.00
Single color, Color off-axis lens		
IPX302-2	3-LED light head, Amber	124.00
IPX302-3	3-LED light head, Blue	124.00
IPX302-4	3-LED light head, Red	124.00
Accessory		
IPXM-1	Chrome bezel, all IMPAXX 3 models	16.00
Common Replacement Part		
Z8613137A	Black bezel, replacement	12.00

Exterior Perimeter Light Brackets



Federal Signal

Effective April 1, 2018



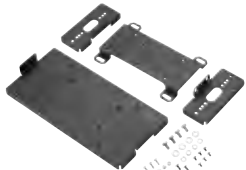

Grille Brackets

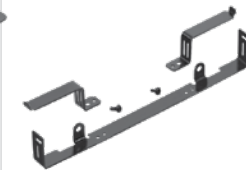
				
IPX-GRL1 \$30.00 IPX3/IPX6, (1) grille bracket with hardware, vertical mount orientation, Ford Crown Victoria Police Package vehicles, 2002-2011	IPX-GRL2 \$30.00 IPX3/IPX6, (1) grille bracket with hardware, horizontal mount orientation, Ford Crown Victoria Police Package vehicles, 2002 - 2011 and Chevy Tahoe, 2010-14	IPX-GRL4 \$30.00 IPX3, pair of grille brackets with hardware, each bracket holds (2) IPX3 lights in a vertical orientation, Chevrolet Caprice 2011-2017	IPX-GRL5 \$30.00 IPX3/IPX6/MPS300/MPS600, pair of grille brackets with hardware, Ford Police Interceptor Sedan, 2013-17, not including Ecoboost models	IPX-GRL6 \$30.00 IPX3/IPX6/MPS300/MPS600, pair of grille brackets with hardware, Ford Police Interceptor Sedan, 2013-17, not including Ecoboost models
				
IPX-GRL7 \$30.00 IPX3/IPX6/MPS300/MPS600, pair of grille brackets with hardware, Chevrolet Tahoe, 2015-2017	IPX-GRL8 \$30.00 IPX3/IPX6/MPS3U/MPS6/MPS6U/MPS12/MPS12U pair of grille brackets with hardware, horizontal mount orientation, Dodge Charger 2015-17 without Rumbler installation	IPX-GRL9 \$30.00 IPX3/MPS3/MPS3U (1) grille bracket with hardware, horizontal mount orientation, Dodge Charger 2015-17, intended for use with Rumbler installation	IPX-GRL10 \$30.00 IPX3/IPX6/MPS3(U)/MPS6(U), grille bracket with hardware, horizontal mount orientation, Ford Police Interceptor Utility, 2017, does not include Ecoboost models	IPX-GRL11 \$30.00 IPX6/MPS6/MPS6U/MPSW9, grille bracket with hardware, horizontal mount orientation, Ford F-150, 2015-17
				
IPX-GRL12 \$30.00 IPX3/IPX6/MPS3/MPS6, grille bracket with hardware, Chevrolet Silverado SSV, 2015-2017	IPX-GRL13 \$30.00 IP3/IPX6/MPS3/MPS6/MPS12, grille bracket with hardware, horizontal mount, Chevy Traverse 2016-2017			



License Plate Brackets

				
IPX-LPV1 \$36.00 IPX3/IPX6, flat surface license plate mount, various vehicles without recessed plate mounting locations	IPX-LPV2 \$49.00 Adjustable license plate mounting kit to mount (2) IPX3, IPX6, MPS3, MPS6, or MPS12 light heads to the license plate of popular vehicles	IPX-LPVX1 \$36.00 IPX3/IPX6, extended license plate bracket for vehicles with a recessed license plate mount location	IPX-LPH1 \$36.00 IPX3/IPX6/MPS3, generic high side license plate holder with horizontal mount tab on each side, fits most vehicles	IPX-LPF1 \$36.00 IPX3 only, generic low side license plate holder for horizontal IMPAXX install, fits most vehicles

Rear Side Window Brackets

				
IPX-SW1 \$36.00	VPX-SW \$72.00	IPX-RSW1 \$72.00	IPX-RSW3 \$72.00	IPX-RSW4 \$72.00
IPX3, pair of rear side window mount brackets, each bracket holds (1) light, Ford Crown Victoria Police Package vehicles, 2002-2011	IPX6, pair of rear side window mount brackets, each bracket holds (2) lights with cover, late model Ford Crown Victoria Police Package vehicles	IPX3/IPX6, pair rear side window mount brackets and covers, Dodge Charger, 2016-2017	IPX3/IPX6, pair of rear side window mount brackets, Ford Police Interceptor Utility, 2013-17	Ford Utility cargo side window mounting kit, pair of brackets/cover to mount (1) MPS6U or (2) IPX3/IPX6/MPS3U on each side of vehicle

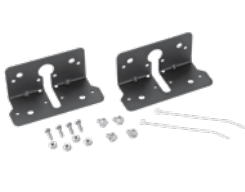

Universal Mount Brackets

		
IPX-PBL1 \$30.00	IPXM6-SPACRKT \$25.00	IPXM6B-SPACRKT \$25.00
IPX3/IPX6, pair, universal "L" bracket, horizontal orientation	Kit of four 5-degree rubber mounting wedges for use with IPX6 lights without bezel	Kit of four 5-degree rubber mounting wedges for use with IPX6 lights with bezel

Trunk Lid Bracket

IPX-TRNK4 \$36.00
IPX3/IPX6/MPS300/MPS600, pair of inner trunk lid brackets with hardware, Ford Police Interceptor Sedan, 2013-17

Push-bumper Brackets

	
IPX-PB45H \$36.00	IPX-PB45V \$36.00
IPX3/IPX6, pair of 45-degree slanted push bumper mounts with hardware, horizontal light orientation, fits most push bumpers	IPX3/IPX6, pair of 45-degree slanted push bumper mounts with hardware, vertical light orientation, fits most push bumpers

Effective April 1, 2018

MicroPulse® Ultra

- Ultra low-profile design offers wide range of mounting options
- Superior warning with 3-, 6-, 12-, or 24-high-powered LEDs
- Multiple units are synchronizable and can flash simultaneously or alternately
- Solid, split, and dual color models are available
- Optional bezels available in Chrome or White
- Ultra 3 (HxLxD) - 1.08 in (2.7 cm) x 3.38 in (8.6 cm) x 0.43 in (1.09 cm)
- Ultra 6 (HxLxD) - 1.26 in (3.2 cm) x 5.2 in (13.26 cm) x 0.37 in (0.94 cm)
- Ultra 12 (HxLxD) - 1.91 in (4.83 cm) x 5.25 in (13.34 cm) x 0.45 in (1.14 cm)
- Three-year warranty



Model	Description	List Price
-------	-------------	------------

MicroPulse Ultra 12, Single and Split Color, Clear lens
Surface mount, 12/24 VDC

MPS1200U-AA	12-LED light head, Amber/Amber LED, Clear lens	\$167.00
MPS1200U-BB	12-LED light head, Blue/Blue LED, Clear lens	167.00
MPS1200U-RR	12-LED light head, Red/Red LED, Clear lens	167.00
MPS1200U-BR	12-LED light head, Red/Blue LED, Clear lens	167.00
MPS1200U-BW	12-LED light head, Blue/White LED, Clear lens	167.00
MPS1200U-RW	12-LED light head, Red/White LED, Clear lens	167.00
MPS1200U-RA	12-LED light head, Red/Amber LED, Clear lens	167.00
MPS1200U-BA	12-LED light head, Blue/Amber LED, Clear lens	167.00
MPS1200U-WA	12-LED light head, White/Amber LED, Clear lens	167.00
MPS1200U-WW	12-LED light head, White/White LED, Clear lens	167.00

MicroPulse Ultra 12, Dual Color, Clear lens
Surface mount, 12/24 VDC

MPS1220U-BA	24-LED light head, Blue/Amber LED, Clear lens	197.00
MPS1220U-BR	24-LED light head, Blue/Red LED, Clear lens	197.00
MPS1220U-BW	24-LED light head, Blue/White LED, Clear lens	197.00
MPS1220U-RA	24-LED light head, Red/Amber LED, Clear lens	197.00
MPS1220U-RW	24-LED light head, Red/White LED, Clear lens	197.00
MPS1220U-AW	24-LED light head, Amber/White LED, Clear lens	197.00

MicroPulse Ultra 12, Single Color, Color lens
Surface mount, 12/24 VDC

MPS1202U-AA	12-LED light head, Amber/Amber LED, Amber lens	177.00
MPS1202U-BB	12-LED light head, Blue/Blue LED, Blue lens	177.00
MPS1202U-GG	12-LED light head, Green/Green LED, Green lens	180.00
MPS1202U-RR	12-LED light head, Red/Red LED, Red lens	177.00

MicroPulse Ultra 6, Single and Split Color, Clear lens
Surface mount, 12/24 VDC

MPS600U-AA	6-LED light head, Amber/Amber LED, Clear lens	146.00
MPS600U-BA	6-LED light head, Blue/Amber LED, Clear lens	146.00
MPS600U-BB	6-LED light head, Blue/Blue LED, Clear lens	146.00
MPS600U-BR	6-LED light head, Blue/Red LED, Clear lens	146.00
MPS600U-BW	6-LED light head, Blue/White LED, Clear lens	146.00
MPS600U-GA	6-LED light head, Green/Amber LED, Clear lens	146.00
MPS600U-RA	6-LED light head, Red/Amber LED, Clear lens	146.00
MPS600U-RR	6-LED light head, Red/Red LED, Clear lens	146.00
MPS600U-RW	6-LED light head, Red/White LED, Clear lens	146.00
MPS600U-WA	6-LED light head, White/Amber LED, Clear lens	146.00
MPS600U-WW	6-LED light head, White/White LED, Clear lens	146.00

Model	Description	List Price
-------	-------------	------------

MicroPulse Ultra 6, Dual Color, Clear lens
Surface mount, 12/24 VDC

MPS620U-BA	12-LED light head, Blue/Amber LED, Clear lens	166.00
MPS620U-BR	12-LED light head, Blue/Red LED, Clear lens	166.00
MPS620U-BW	12-LED light head, Blue/White LED, Clear lens	166.00
MPS620U-RA	12-LED light head, Red/Amber LED, Clear lens	166.00
MPS620U-RW	12-LED light head, Red/White LED, Clear lens	166.00
MPS620U-WA	12-LED light head, White/Amber LED, Clear lens	166.00

MicroPulse Ultra 6, Single Color, Color lens
Surface mount, 12/24 VDC

MPS602U-AA	6-LED light head, Amber/Amber LED, Amber lens	156.00
MPS602U-BB	6-LED light head, Blue/Blue LED, Blue lens	156.00
MPS602U-RR	6-LED light head, Red/Red LED, Red lens	156.00

MicroPulse Ultra 3
Surface mount, 12/24 VDC, Clear lens

MPS300U-A	3-LED light head, Amber LED, Clear lens	100.00
MPS300U-B	3-LED light head, Blue LED, Clear lens	100.00
MPS300U-R	3-LED light head, Red LED, Clear lens	100.00
MPS300U-W	3-LED light head, White LED, Clear lens	100.00

MicroPulse Ultra 3
Surface mount, 12/24 VDC, Color lens

MPS302U-A	3-LED light head, Amber LED, Amber lens	110.00
MPS302U-B	3-LED light head, Blue LED, Blue lens	110.00
MPS302U-R	3-LED light head, Red LED, Red lens	110.00

Accessories and Kits

MPSUM6-1	Chrome bezel for (1) MicroPulse Ultra 600	14.00
MPSUM6-2	White bezel for (1) MicroPulse Ultra 600	14.00
MPSUM12-1	Chrome bezel for (1) MicroPulse Ultra 1200	14.00
MPSUM12-2	White bezel for (1) MicroPulse Ultra 1200	14.00
MPSUM3-1	Chrome bezel for (1) MicroPulse Ultra 300	14.00
MPSUM3-2	White bezel for (1) MicroPulse Ultra 300	14.00



Low-profile design as compared to a dime



Optional Chrome bezel MPSUM6-1 shown with MPS600U-RR



Optional white bezel MPSUM6-2 shown with MPS600U-BR

MicroPulse®

- Multiple mounting options for various applications
- Superior warning with six or twelve high-powered LEDs
- Solid, split, and dual color models are available
- LEDs offered in Amber, Blue, Red and White
- Single/multi-unit synchronization
- Three-year warranty



MPS600-RR

Model	Description	List Price
MicroPulse 6, Single and Split Color Surface mount, 12/24 VDC		
MPS600-AA	6-LED light head, Amber/Amber	\$146.00
MPS600-BB	6-LED light head, Blue/Blue	146.00
MicroPulse 6, Split Color Surface mount, 12/24 VDC		
MPS600-RB	6-LED light head, Red/Blue	146.00
MPS600-RR	6-LED light head, Red/Red	146.00
MicroPulse 6, Single Color Hood/Grille mount, 12/24 VDC		
MPS650-AA	6-LED light head, Amber/Amber	146.00
MPS650-BB	6-LED light head, Blue/Blue	146.00
MPS650-RR	6-LED light head, Red/Red	146.00
MPS650-WW	6-LED light head, White/White	146.00
MicroPulse 6, Dual Color Hood/Grille mount, 12/24 VDC		
MPS652-BA	12-LED light head, Blue/Amber	166.00
MPS652-BR	12-LED light head, Blue/Red	166.00
MPS652-BW	12-LED light head, Blue/White	166.00
MPS652-RA	12-LED light head, Red/Amber	166.00
MPS652-RW	12-LED light head, Red/White	166.00
MPS652-WA	12-LED light head, White/Amber	166.00

MicroPulse® C Series

- Superior warning with six high-powered LEDs
- Single and split color models are available
- Includes Black surface mount bezel and stud mount
- Low-profile for discreet mounting
- Single/multi-unit synchronization
- Twenty-seven selectable flash patterns including steady and random
- Three-year warranty



MPSC-RW

MPSC-W

Model	Description	List Price
MicroPulse C Series, Single Color, Clear lens Surface and stud mount, 12 VDC		
MPSC-A	6-LED light head, Amber LEDs	\$149.00
MPSC-B	6-LED light head, Blue LEDs	149.00
MPSC-R	6-LED light head, Red LEDs	149.00
MPSC-W	6-LED light head, White LEDs	149.00
MicroPulse C Series, Split Color, Clear lens Surface and stud mount, 12 VDC		
MPSC-RB	6-LED light head, Red/Blue LEDs	149.00
MPSC-RW	6-LED light head, Red/White LEDs	149.00
MPSC-BW	6-LED light head, Blue/White LEDs	149.00
MPSC-AW	6-LED light head, Amber/White LEDs	149.00
Accessories and Kits		
MPSMC-2	White bezel for (1) MicroPulse C Series light head	14.00
MPSMC-1	Chrome bezel for (1) MicroPulse C Series light head	14.00

Effective April 1, 2018

MicroPulse® Wide Angle

- Utilizes 6-, 9- or 12-LEDs, 180-degree light spread
- Perfect for mounting on push bumpers, rub rails, side mirrors and spoilers
- Black bezel included with light, optional Chrome or White bezel available
- Synchronization with other MicroPulse products
- Available in Amber, Blue, Red and White
- Single color, split color, and dual color models are available
- MicroPulse Wide Angle 9 (HxLxD) - 1.5 in (3.8 cm) x 5.1 in (12.9 cm) x 1.5 in (3.8 cm)
- MicroPulse Wide Angle 6 (HxLxD) - 1.4 in (3.5 cm) x 3.8 in (9.7 cm) x 1.5 in (3.8 cm)
- Three-year warranty



MPSW9-R

Model	Description	List Price
MicroPulse Wide Angle 9, Single Color		
Surface mount, 12/24 VDC		
MPSW9-A	9-LED light head, Amber	\$219.00
MPSW9-B	9-LED light head, Blue	219.00
MPSW9-R	9-LED light head, Red	219.00
MPSW9-W	9-LED light head, White	219.00
MicroPulse Wide Angle 9, Dual Color		
Surface mount, 12 VDC		
MPSW9-BA	12-LED light head, Blue/Amber	229.00
MPSW9-RA	12-LED light head, Red/Amber	229.00
MPSW9-AW	12-LED light head, Amber/White	229.00
MPSW9-RB	12-LED light head, Red/Blue	229.00
MPSW9-BW	12-LED light head, Blue/White	229.00
MPSW9-RW	12-LED light head, Red/White	229.00
MPSW9-AG	12-LED light head, Amber/Green	229.00
MicroPulse Wide Angle 6, Single Color		
Includes surface mount and side mirror mount, 12 VDC		
MPSW6-A	6-LED light head, Amber	189.00
MPSW6-B	6-LED light head, Blue	189.00
MPSW6-R	6-LED light head, Red	189.00
MPSW6-W	6-LED light head, White	189.00
MicroPulse Wide Angle 6, Split Color		
Includes surface mount and side mirror mount, 12 VDC		
MPSW6-RB	6-LED light head, Red/Blue	189.00
MPSW6-RW	6-LED light head, Red/White	189.00
MPSW6-BW	6-LED light head, Blue/White	189.00
MPSW6-AW	6-LED light head, Amber/White	189.00
Accessories and Kits		
MPSMW6-1	Chrome bezel for (1) MPSW6	15.00
MPSMW6-2	White bezel for (1) MPSW6	15.00
MPSMW6-3	Black bezel for (1) MPSW6	15.00
MPSMW9-1	Chrome bezel for (1) MPSW9	15.00
MPSMW9-3	Black bezel for (1) MPSW9	15.00

MicroPulse® Flashing/Marker





- Superior warning with high-powered LEDs
- Low-profile for discreet mounting
- FMVSS (Federal Motor Vehicle Safety Standards) marker light and warning light in one solution









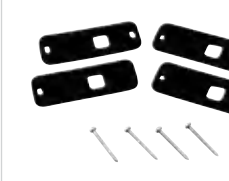





MPS600M-RA

Model	Description	List Price
MPS600M-RA	6-LED light head, (3) LED Red marker light, (3) LED Amber flashing	\$146.00
MPS600M-AA	6-LED light head, (3) LED Amber marker light, (3) LED Amber flashing	146.00

MicroPulse 3 and MicroPulse Ultra 3

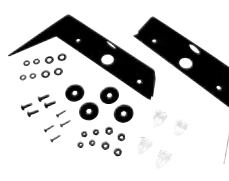

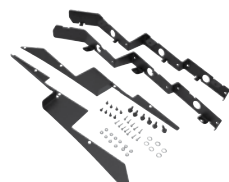

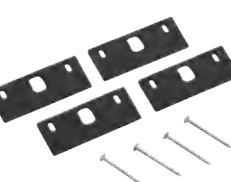
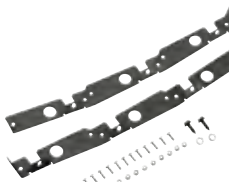

				
MPSM3-LB \$15.00 Generic L-Bracket for (1) MPS300/MPS300U light	MPSM3-DS \$19.00 Generic L-Bracket for (2) MPS300/MPS300U lights, stacked	MPSM3-DL \$19.00 Generic L-Bracket for (2) MPS300/MPS300U lights, side-by-side	MPSM3-SB \$25.00 Swivel Mount Bracket for (1) MPS300/MPS300U light	MPSM3U-SPACRKT \$19.00 Kit of four 5-degree rubber mounting wedges for use with MPS300U lights

MicroPulse 6 and MicroPulse Ultra 6

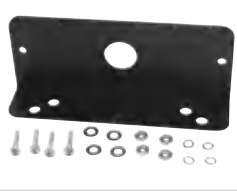





				
MPSM6-LB \$15.00 Generic L-Bracket for (1) MPS600 light or (1) MPS600U light	MPSM6-DS \$19.00 Generic L-Bracket for (2) MPS600 lights stacked or (2) MPS600U lights stacked	MPSM6-DL \$19.00 Generic L-Bracket for (2) MPS600 lights side-by-side or (2) MPS600U lights side-by-side	MPSM6-SB \$25.00 Swivel mount bracket for (1) MPS600 light or (1) MPS600U light	MPSM6-BOOT \$25.00 Rubber boot mount for (1) MPS600 light
				
MPSM6-BOOTKIT \$55.00 (2) Rubber boot mounts, (2) mounting plates for (2) MPS600 lights	MPSM6-SPACRKT \$24.00 Kit of four 5-degree rubber mounting wedges for use with MPS600 lights	MPSM6U-SPACRKT \$24.00 Kit of four 5-degree rubber mounting wedges for use with MPS600U lights	MPSM6-FPIURS \$93.00 2013-2018 Ford Interceptor Utility spoiler bracket kit, (2) MPS600 lights or (2) MPS600U lights	MPSM6-FPIURS2 \$72.00 2013-2018 Ford Interceptor Utility spoiler bracket kit, (6) MPS600 lights or (6) MPS600U lights
				
MPSM6-TA15RS \$72.00 2015-2018 Chevrolet Tahoe spoiler bracket kit, (6) MPS600 lights or (6) MPS600U lights	MPSM6-FPISSM \$120.00 Kit, MPS side marker mount, Ford Interceptor Sedan	MPSM650-SPACRKT \$24.00 Kit of four 5-degree rubber mounting wedges for use with (2) MPS650 lights	MPSM6-DU15RS \$72.00 2015-2018 Dodge Durango spoiler bracket kit, (6) MPS600, (6) MPS600U or (6) MPS620U lights	

Effective April 1, 2018



MicroPulse 12 and MicroPulse Ultra 12

				
MPSM12-LB \$15.00	MPSM12-DS \$19.00	MPSM12-DL \$19.00	MPSM12-SB \$25.00	MPSM12U-SPACRKT \$24.00
Generic L-Bracket for (1) MPS1200 or (1) MPS1200U light	Generic L-Bracket for (2) MPS1200 or (2) MPS1200U lights, stacked	Generic L-Bracket for (2) MPS1200 or (2) MPS1200U lights, side-by-side	Swivel mount bracket for (1) MPS1200 or (1) MPS1200U light	Kit of four 5-degree rubber mounting wedges for use with MPS1200U lights
				
MPSUMO12-1 \$19.00	MPSUMO12-3 \$19.00			
Chrome oval bezel for (1) MicroPulse Ultra 1200U	Black oval bezel for (1) MicroPulse Ultra 1200U			

MicroPulse Wide Angle

				
MPSMW9-LB \$15.00	MPSMW9-SPACRKT \$24.00	MPSMW9-TAH15MIR \$30.00	MPSMW9-FPIU13MIR \$30.00	MPSMW9-DUR15MIR \$30.00
L-Bracket for (1) MPSW9	Kit of four 5-degree rubber mounting wedges for use with MPSW9 lights	Pair of side mirror brackets for 2015-2018 Tahoe, each bracket holds a single MPSW9 light	Pair of side mirror brackets for 2015-2018 Ford Interceptor Utility, each bracket holds a single MPSW9 light	Pair of side mirror brackets for 2015-2018 Dodge Durango and 2016-2018 Dodge Ram SSV, each bracket holds a single MPSW9 light
				
MPSMW6-SPACRKT \$24.00				
Kit of four 5-degree rubber mounting wedges for use with MPSW6 lights				

MicroPulse C Series

	
MPSMC-SPACRKT \$24.00	330508 \$33.00
Kit of four 5-degree rubber mounting wedges for use with MPSC lights	6" oval grommet for (1) MPS1200U or (1) MPSW9 light

Latitude™ Flashing Models

- LED flashing warning light suitable for both interior and exterior mounting applications
- Available in four, six or eight-head models
- Three-LEDs per light head
- Optional mounting brackets available
- Ten Flash patterns plus one test pattern
- Innovative co-extrusion, polycarbonate housing provides moisture resistance
- Solaris® LED reflector technology for better optical efficiency and superior off-axis warning
- Patented ROC (Reliable Onboard Circuitry™) technology
- Five-year warranty



Model	Description	List Price
4-Head flashing models		
SL4F-2R2B	(2) Red LED reflectors, (2) Blue LED reflectors (alternating) R-B-R-B	\$320.00
SL4F-RB	(2) Red LED reflectors, (2) Blue LED reflectors R-R-B-B	320.00
SL4F-R	(4) Red LED reflectors, R-R-R-R	320.00
SL4F-B	(4) Blue LED reflectors, B-B-B-B	320.00
SL4F-A	(4) Amber LED reflectors, A-A-A-A, (does not include directional functions)	320.00
SL4FF-RW	(2) Red LED reflectors, (2) White LED reflectors, R-W-R-W (Includes white light cut-off option)	320.00
6-Head flashing models		
SL6F-RB	(3) Red LED reflectors, (3) Blue LED reflectors, R-R-R-B-B-B	460.00
SL6F-R	(6) Red LED reflectors, R-R-R-R-R-R	460.00
SL6F-B	(6) Blue LED reflectors, B-B-B-B-B-B	460.00
SL6F-A	(6) Amber LED reflectors, A-A-A-A-A-A, (does not include directional functions)	460.00
SL6FF-RW	(3) Red LED reflectors, (3) White LED reflectors, R-W-R-W-R-W (Includes white light cut-off option)	460.00
8-Head flashing models		
SL8F-RB	(4) Red LED reflectors, (4) Blue LED reflectors, R-R-R-R-B-B-B-B	520.00
SL8F-R	(8) Red LED reflectors, R-R-R-R-R-R-R-R	520.00
SL8F-B	(8) Blue LED reflectors, B-B-B-B-B-B-B-B	520.00
SL8F-A	(8) Amber LED reflectors, A-A-A-A-A-A-A-A, (does not include directional functions)	520.00
SL8FF-RW	(4) Red LED reflectors, (4) White LED reflectors, R-W-R-W-R-W-R-W (Includes white light cut-off option)	520.00
Mounting Brackets		
320310	Flush mount, vertical surface	39.00
320320	Light bar or rear deck mount	45.00
320330	System mount	55.00
320340	Universal mount	114.00
320350	Foot adapter mount	33.00
SLB-6SHRD	6-head shroud, Latitude only	25.00
SLB-001	Long L-bracket, CN SignalMaster or Latitude	20.00
SLB-002	Short L-bracket, CN SignalMaster or Latitude	20.00
SLB-4SHRD	4-head shroud, CN SignalMaster or Latitude	25.00
SLB-8SHRD	8-head shroud, CN SignalMaster or Latitude	30.00

NOTE

See page 61 for Latitude SignalMaster models

4-Head Configurations

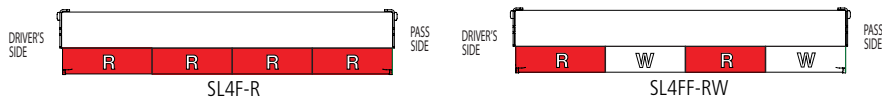

6-Head Configurations



8-Head Configurations

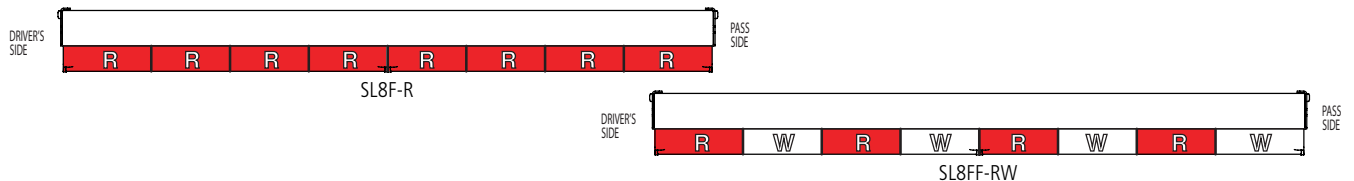

Effective April 1, 2018

Corner LED Features Comparison

	416200 Series	416900 Series	416910 Series	416300
# of LED Light heads per model	Pair	Single	Single	Single
Mounting	Internal	External/Internal	External/Internal	External/Internal
Sync Flashing	•	•	•	•
Single color	•		•	•
Dual color		•		
Number of LEDs per light head	9	12	12	3
Warranty (years)	3	5	5	3

In-Line Corner LED Systems (416200)

- Corner LED lights with “in-line” flasher circuit
- Nine-LEDs per light head
- Nineteen built-in selectable flash patterns
- Multiple units can be synchronized and flash simultaneously or alternately
- Suitable for internal mounting only
- Three-year warranty



Model	Description	List Price
Two-head In-line Corner LED Systems: (2) LED heads with in-line flasher and cables		
416200-33	(2) 9-LED light heads with in-line flasher, Blue/Blue	\$189.00
416200-43	(2) 9-LED light heads with in-line flasher, Red/Blue	189.00
416200-44	(2) 9-LED light heads with in-line flasher, Red/Red	189.00
416200-55	(2) 9-LED light heads with in-line flasher, Clear/Clear	189.00

416300 Series

- Utilizes three LEDs
- Seventeen flash patterns including random and steady
- Single/multi-unit synchronization
- Flush mount with included grommet; optional L-bracket sold separately
- UV resistant polycarbonate lens
- Three-year warranty



Model	Description	List Price
Flush mount, 12 VDC		
416300-A	3-LED light head, Amber	\$99.00
416300-B	3-LED light head, Blue	99.00
416300-R	3-LED light head, Red	99.00
416300-W	3-LED light head, White	99.00
Accessory		
416301	L-bracket kit	7.00

Corner LED Systems (416900/416910)

- Suitable for external and internal use
- Nineteen built-in selectable flash patterns
- Multiple heads can be synchronized and can flash simultaneously or alternately
- Twelve LEDs per light head
- Available in single and dual color models
- Two mounting options; bezel for surface mounting or can be installed in a head lamp
- Three-year warranty



Model	Description	List Price
Single color, single-head in-line Corner LED Systems: (1) LED head with in-line flasher, cables, and Black bezel, 12/24 VDC		
416910-A	12-LED light head, Amber	\$109.00
416910-B	12-LED light head, Blue	109.00
416910-R	12-LED light head, Red	109.00
416910-W	12-LED light head, White	109.00
Dual color, single-head in-line Corner LED Systems: (1) LED head with in-line flasher, cables, and Black bezel, 12/24 VDC		
416900-BA	12-LED light head, Blue/Amber	109.00
416900-BW	12-LED light head, Blue/White	109.00
416900-RA	12-LED light head, Red/Amber	109.00
416900-RB	12-LED light head, Red/Blue	109.00
416900-RW	12-LED light head, Red/White	109.00
416900-AW	12-LED light head, Amber/White	109.00
Accessories		
416900-BZC	Chrome bezel for 416900/416910 series	10.00
416900-BZW	White bezel for 416900/416910 series	10.00

Effective April 1, 2018

Commander® Flashing and Marker Lights

- Multipurpose surface mount warning and marker lights; small size allows for various mounting locations on vehicle
- Flashing models available with a single flash pattern or steady burn pattern to be used with an external flasher
- Marker/clearance lights meet SAE J592 and J2042
- The LED Illumination light meets the NFPA step light spec (13.10.3) and is available in a surface mount and 45-degree angle mount
- All models are fully encapsulated to prevent any moisture issues
- All models include a Chrome flange and mounting gasket
- Five-year warranty



COM1FC-W

Model	Description	List Price
Flashing Light, Surface Mount		
COM1FC-A	4-LED light head, Chrome flange, Amber	\$29.00
COM1FC-B	4-LED light head, Chrome flange, Blue	35.00
COM1FC-R	4-LED light head, Chrome flange, Red	29.00
COM1FC-W	4-LED light head, Chrome flange, White	35.00
Marker Light, Surface Mount		
COM1MC-A	4-LED light head, Chrome flange, Amber	29.00
COM1MC-G	4-LED light head, Chrome flange, Green	35.00
COM1MC-R	4-LED light head, Chrome flange, Red	29.00
Steady burn light to be used with an external flasher, Surface Mount		
COM1SC-A	4-LED light head, Chrome flange, Amber	29.00
COM1SC-B	4-LED light head, Chrome flange, Blue	35.00
COM1SC-R	4-LED light head, Chrome flange, Red	29.00
White Illumination light, Surface Mount		
COM1LC-W	3-LED light head, Chrome flange, White	40.00
COM145LC-W	3-LED light head, 45-degree mount, Chrome flange, White	42.00

Commander® 3" Flashing and Compartment Lights

- Standard 3-inch round surface mount flashing and compartment lights with an aluminum base
- Surface mount alleviates the need to do body cut-outs on the vehicle
- Low-profile design allows for versatile mounting options
- All models include bolt or adhesive mount for added flexibility in mounting
- All flashing models include one flash pattern
- Two-color compartment lights allow for separate control of colors
- Red LED compartment lights are ideal for improved nighttime vision in compartments
- Chrome flange and rubber grommet available
- Meets SAE J845 and J595 Class 2
- Five-year warranty



COM3FRC

Model	Description	List Price
Single Color, Flashing Light, Surface Mount, Clear lens		
COM3FAC	6-LED, 3" round light, Amber LED	\$70.00
COM3FBC	6-LED, 3" round light, Blue LED	70.00
COM3FRC	6-LED, 3" round light, Red LED	70.00
Single Color, Flashing Light, Surface Mount, Color lens		
COM3FAA	6-LED, 3" round light, Amber LED, Amber lens	70.00
COM3FBB	6-LED, 3" round light, Blue LED, Blue lens	70.00
COM3FRR	6-LED, 3" round light, Red LED, Red lens	70.00
Single Color, Compartment Light, Surface Mount		
COM3SWC	6-LED, 3" round light, White LED, Clear lens	70.00
COM3SRR	6-LED, 3" round light, Red LED, Red lens	70.00
Two Color, Compartment Light, Surface Mount		
COM3SBWC	6-LED, 3" round light, Blue/White LED, Clear lens, Separate control of colors	78.00
COM3SRWC	6-LED, 3" round light, Red/White LED, Clear lens, Separate control of colors	78.00
Accessories and Kits		
COM3FLANGEC	3" round Chrome flange for COM3 lights	13.00
COM3GROMMET	Kit, Grommet for COM3 lights	8.00

SignalTech® LED Lights

- Reflector cell technology enhances brightness and reduces sunlight washout
- Enhanced lens design for a uniform pattern
- Solid-state components are potted to withstand rugged road conditions
- FMVSS (Federal Motor Vehicle Safety Standards) 108 compliant
- Three-year warranty



607123-02SB

607123-04SB

Model	Description	List Price
Kits includes LED light, rubber mounting grommet, sealed wire harness		
4" Round LED light kits		
607123-02SB	PAR 36, Amber; -03SB(Blue); -04SB(Red); -05SB(Clear)	\$91.00
6" Oval LED light kit		
607101-02SB	Amber; -03SB(Blue); -04SB(Red); -05SB(Clear)	94.00
S/T/T and Back-up lights		
Kits includes LED light, rubber mounting grommet, sealed wire harness		
4" Round LED light kits		
607100-04SB	LED Stop/Tail/Turn light, 12/24 VDC, Red	52.00
607102-02SB	LED turn light, 12/24 VDC, Amber	51.00
607124-05SB	LED back-up light, 12/24 VDC, White	134.00
607124-05SB-DEU	LED back-up light, 12/24 VDC, White with Deutsch	137.00
6" Oval LED light kits		
607105-04SB	LED Stop/Tail/Turn light, 12/24 VDC, Red	54.00
607106-02SB	LED turn light, 12/24 VDC, Amber	57.00
607125-05SB	LED back-up light, 12/24 VDC, White	139.00
Side Marker/Clearance Lights, 12 VDC		
607120-02SB	2.5" round, Amber; -04(Red)	15.00
Indicator Light		
607121-04SB	1.5" flashing and steady, Red	32.00
SignalTech Compartment Lights		
607141-05	Round, 4" White LED compartment lights (kit includes LED light head, Black mounting grommet and sealed beam harness)	134.00
607141-05GRAY	Round, 4" White LED compartment lights, (kit includes LED light head, Gray mounting grommet and sealed beam harness)	134.00
Accessories and Kits		
605501-02SB	6" oval flashing LED light head, Amber; -04(Red)	85.00
605520SB	Kit, rubber mounting grommet, 4" round	6.00
605510SSG	Kit, rubber mounting grommet, 6" oval	6.00
605523-02SB	4" round flashing LED light head, Amber; -03(Blue); -04(Red)	82.00
605500SB	Sealed wire harness for flashing LED light heads	9.00
607109SB	Sealed wire harness for S/T/T and Turn LED light heads	9.00
605530SB	2.5" round mounting grommet	6.00

Effective April 1, 2018

Interior Mount Warning Light Comparison

	SpectraLux® ILS Low-profile	SpectraLux® ILS Rear Hatch	XStream™
Discrete wired option	•	•	•
Multicolor	•	•	•
Number of LEDs *	6, 12 or 18 per head	6, 12 or 18 per head	18 per head, 6 of each color
LED Takedown	•		•
LED SignalMaster™		•	
Flood Lighting	•		
Sync	•	•	•
Warranty (years)	5	5	5
Solaris® LED Reflector Technology	•	•	•
ROC (Reliable Onboard Circuitry™)	•	•	
FS Convergence Network	•	•	
Multicolor LED Technology	•	•	•
FSLink™			•

NOTE

* Number of LEDs determined by color combination

SpectraLux® ILS Low-profile



- Slimmer internal lighting system that reduces windshield obstruction and improves visibility
- Single, dual or three color light heads (6-, 12- or 18-LEDs per light head)
- Vehicle specific shrouds to prevent flash-back for most common vehicle applications
- LEDs offered in Amber, Blue, Green, Red or White
- Available in Advanced Off-Axis and Center-Focused models
- multicolor technology provides "all-white" flood lighting in front headliner models, as well as "Amber-override" directional lighting in rear deck models
- Solaris® LED reflector technology for better optical efficiency and superior off-axis warning
- Compatible with FS Convergence Network for "plug-and-play" installation and programming
- Patented ROC (Reliable Onboard Circuitry™) technology
- Five-year warranty



Model	Description	List Price
Advanced Off-Axis Models		
SpectraLux ILS Low-profile preselect models for Chevrolet Tahoe 2015+ and Chevrolet Silverado SSV 2015+		
SIFZS-3153225	Split Front Headliner, (6) Red LED reflectors, (2) Red/White LED reflectors, without interface module	\$1,280.00
SIFZS-3433498	Split Front Headliner, (6) Red LED reflectors, (2) Red/White LED reflectors, with interface module	1,350.00
SIFZS-3151220	Split Front Headliner, (8) Red/White LED reflectors, without serial interface module	1,550.00
SIFZS-3433507	Split Front Headliner, (8) Red/White LED reflectors, with serial interface module	1,620.00
SpectraLux ILS Low-profile preselect models for Ford Interceptor Utility 2013+		
SIFZS-3153226	Split Front Headliner, (6) Red LED reflectors, (2) Red/White LED reflectors, without interface module	1,280.00
SIFZS-3433509	Split Front Headliner, (6) Red LED reflectors, (2) Red/White LED reflectors, with interface module	1,350.00
SIFZS-3153222	Split Front Headliner, (8) Red/White LED reflectors, without serial interface module	1,550.00
SIFZS-3433511	Split Front Headliner, (8) Red/White LED reflectors, with serial interface module	1,620.00
SpectraLux ILS Low-profile preselect models for Ford F-150/250/350 2015+		
SIFZS-3433515	Split Front Headliner, (6) Red LED reflectors, (2) Red/White LED reflectors, without interface module	1,280.00
SIFZS-3433567	Split Front Headliner, (6) Red LED reflectors, (2) Red/White LED reflectors, with interface module	1,350.00
SIFZS-3433574	Split Front Headliner, (8) Red/White LED reflectors, without serial interface module	1,550.00
SIFZS-3433577	Split Front Headliner, (8) Red/White LED reflectors, with serial interface module	1,620.00
SpectraLux ILS Low-profile preselect models for Dodge Ram 2016+		
SIFZS-3604257	Split Front Headliner, (6) Red LED reflectors, (2) Red/White LED reflectors, without interface module	1,280.00
SIFZS-3604252	Split Front Headliner, (6) Red LED reflectors, (2) Red/White LED reflectors, with interface module	1,350.00
SIFZS-3604266	Split Front Headliner, (8) Red/White LED reflectors, without serial interface module	1,550.00
SIFZS-3604263	Split Front Headliner, (8) Red/White LED reflectors, with serial interface module	1,620.00
Center-Focused Models		
SpectraLux ILS Low-profile preselect models for Ford Interceptor Utility 2013+		
SIFMS-3433588	Split Front Headliner, (6) Red LED reflectors, (2) Red/White LED reflectors, without interface module	1,280.00
SIFMS-3433591	Split Front Headliner, (6) Red LED reflectors, (2) Red/White LED reflectors, with interface module	1,350.00
SIFMS-3433593	Split Front Headliner, (8) Red/White LED reflectors, without serial interface module	1,550.00
SIFMS-3433596	Split Front Headliner, (8) Red/White LED reflectors, with serial interface module	1,620.00
SIFMH-3604058	Rear Hatch, (2) Red LED reflectors, (6) Amber LED reflectors, discrete	1,260.00
SIFMH-3604060	Rear Hatch, (8) Amber LED reflectors, discrete	1,260.00
SIFMH-3604065	Rear Hatch, (8) Red/Amber LED reflectors, discrete	1,620.00
SpectraLux ILS Low-profile preselect models for Chevrolet Tahoe 2015+ and Chevrolet Silverado SSV 2015+		
SIFMS-3662660	Split Front Headliner, (6) Red LED reflectors, (2) Red/White LED reflectors, without interface module	1,280.00
SIFMS-3662665	Split Front Headliner, (6) Red LED reflectors, (2) Red/White LED reflectors, with interface module	1,350.00
SIFMS-3662669	Split Front Headliner, (8) Red/White LED reflectors, without serial interface module	1,550.00
SIFMS-3662674	Split Front Headliner, (8) Red/White LED reflectors, with serial interface module	1,620.00
SpectraLux ILS Low-profile preselect models for Chevrolet Tahoe 2015+		
SIFMH-3662652	Rear Hatch, (2) Red LED reflectors, (6) Amber LED reflectors, discrete	1,260.00
SIFMH-3662663	Rear Hatch, (8) Amber LED reflectors, discrete	1,260.00
SIFMH-3654314	Rear Hatch, (8) Red/Amber LED reflectors, discrete	1,620.00

 Online Light bar Configurator

Effective April 1, 2018

SpectraLux® ILS Low-profile



Chevrolet Tahoe/Silverado	SIFZS-3153225 (without interface module)
Chevrolet Tahoe/Silverado	SIFZS-3433498 (with interface module)
Ford Interceptor Utility	SIFZS-3153226 (without interface module)
Ford Interceptor Utility	SIFZS-3433509 (with interface module)
Ford F-150/250/350	SIFZS-3433515 (without interface module)
Ford F-150/250/350	SIFZS-3433567 (with interface module)
Dodge Ram	SIFZS-3604257 (without interface module)
Dodge Ram	SIFZS-3604252 (with interface module)

Chevrolet Tahoe/Silverado	SIFZS-3151220 (without interface module)
Chevrolet Tahoe/Silverado	SIFZS-3433507 (with interface module)
Ford Interceptor Utility	SIFZS-3153222 (without interface module)
Ford Interceptor Utility	SIFZS-3433511 (with interface module)
Ford F-150/250/350	SIFZS-3433 574 (without interface module)
Ford F-150/250/350	SIFZS-3433577 (with interface module)
Dodge Ram	SIFZS-3604266 (without interface module)
Dodge Ram	SIFZS-3604263 (with interface module)

Center focused models

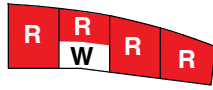

Ford Interceptor Utility	SIFMS-3433588 (without interface module)
Ford Interceptor Utility	SIFMS-3433591 (with interface module)
Chevrolet Tahoe	SIFMS-3662660 (without interface module)
Chevrolet Tahoe	SIFMS-3662665 (with interface module)

Ford Interceptor Utility	SIFMS-3433593 (without interface module)
Ford Interceptor Utility	SIFMS-3433596 (with interface module)
Chevrolet Tahoe	SIFMS-3662669 (without interface module)
Chevrolet Tahoe	SIFMS-3662674 (with interface module)

Rear Hatch models



Ford Interceptor Utility	SIFMH-3604065 (Discrete)
Chevrolet Tahoe	SIFMH-3654314 (Discrete)

Ford Interceptor Utility	SIFMH-3604060 (Discrete)
Chevrolet Tahoe	SIFMH-3662663 (Discrete)



Ford Interceptor Utility	SIFMH-3604058 (Discrete)
Chevrolet Tahoe	SIFMH-3662652 (Discrete)

XStream™

- Solaris® LED reflector technology for better optical efficiency and superior off-axis warning
- SpectraLux® multicolor LED technology in combinations of Amber, Blue, Green, Red and White
- Each head includes three colors; (18) LEDs, (6) of each color
- Low-profile design
- Available in single- or dual-head models
- Black polycarbonate housing
- Each model features two recessed buttons, one button to change flash pattern and another for color mode
- Twenty-five flash patterns including random and steady; ten color modes
- Versatile mounting brackets and three different length snap-on flash guards included
- Choice of cigarette plug or synchronized models
- Cigarette plug models include two switches for on/off and steady-burn
- SAE J595 Class 1, SAE J845 Class 1, CA Title 13 Class B
- Five-year warranty



Signal-head



Dual-head



Model	Description	List Price
Single-head with wire leads		
XSM1-BRW	Blue/Red/White	\$199.00
XSM1-WAG	White/Amber/Green	199.00
XSM1-BRA	Blue/Red/Amber	199.00
XSM1-BWA	Blue/White/Amber	199.00
Dual-head with wire leads		
XSM2-BRW	Blue/Red/White - Blue/Red/White	399.00
XSM2-WAG	White/Amber/Green - White/Amber/Green	399.00
XSM2-BRA	Blue/Red/Amber - Blue/Red/Amber	399.00
XSM2-BWA	Blue/White/Amber - Blue/White/Amber	399.00
Single-head with cigarette plug		
XSM1C-BRW	Blue/Red/White	199.00
XSM1C-WAG	White/Amber/Green	199.00
XSM1C-BWA	Blue/White/Amber	199.00
Dual-head with cigarette plug		
XSM2C-BRW	Blue/Red/White - Blue/Red/White	399.00
XSM2C-WAG	White/Amber/Green - White/Amber/Green	399.00
XSM2C-BWA	Blue/White/Amber - Blue/White/Amber	399.00
Accessories and Kits		
XSMBKT01	Visor mount kit for use with single- or dual-head models	21.00
XSMBKT02	Adjustable, swivel mount for single- or dual-head models	45.00
XSMBKT03	Headliner mount bracket for single- or dual-head models	21.00



XSM2-BRW shown mounted in a vehicle



Each model includes light head, two suction cups, bail and pivot brackets, mounting hardware and three different length snap-on flash guards.

LED Beacon Features Comparison

	SLR Beacon	IVP SLR Beacon Rotating Models	IVP SLR Beacon Oscillating Models	LP800	Pro LED Beacon
SLR (Solaris® LED Rotator)	•	•	•		
Solaris® LED Reflector Technology	•	•	•	•	•
Rotating Function	•	•			
FSLink™					•
RPM	75/90/120	75/90/120			
Oscillating Function			•		
Flash Patterns	3	3	3	14	25
LED Count	12	12	12	30	36,72
NFPA	•	•	•	•	•
Available LED Colors	A,R	A,R	R	A,B,R	A,B,G,R,W
Available Dome Colors	A,C,R	A,C,R	C,R	A,B,C,R	A,B,C,G,R
LED Warranty (years)	5	5	5	5	5

SLR Beacon

- Rotating LED beacon with (12) high-powered LEDs
- Utilizes Federal Signal's patented Solaris® LED reflector technology
- 75/90/120 RPM
- Domes available in Amber, Clear or Red
- Five-year warranty



262650-02



Model	Description	List Price
Models with permanent/pipe mount		
262650-02	Amber LED, Amber dome, Class 1	\$519.00
262650-04	Red LED, Red dome, Class 1	519.00
272650-02	Amber LED, Amber dome, Class 2	449.00
272650-25	Amber LED, Clear dome, Class 2	449.00

NOTE

- Visit www.fedsig.com to view SLR Beacon flash patterns

IVP SLR

- Modern dome design complements the appearance of the Vision® SLR family of light bars
- Patented Solaris® LED rotator for a true 360-degree sweeping coverage
- NFPA compliant models available
- Domes are available in Clear or Red
- Five-year warranty



VSLR1-R1A02



Model	Description	List Price
Rotating Models		
VSLR1-R1	Red LED, Red dome	\$725.00
VSLR1-R2	Red LED, Clear dome	725.00
VSLR1-R1A02	Red LED, Red dome, Amber IPX6	925.00
VSLR1-R2A02	Red LED, Clear dome, Amber IPX6	925.00
VSLR1-R1B12	Red LED, Red dome, Blue IPX6	925.00

Oscillating Models

VSLR1P-R1	Red LED, Red dome, passenger side	725.00
VSLR1D-R1	Red LED, Red dome, driver side	725.00
VSLR1P-R2	Red LED, Clear dome, passenger side	725.00
VSLR1D-R2	Red LED, Clear dome, driver side	725.00

NOTE

- See complete NFPA perimeter lighting available at www.fedsig.com

Effective April 1, 2018

LP800

- Dual level beacon with Solaris® LED reflector technology
- Fourteen Selectable flash patterns
- Multiple-voltage, 12/24 VDC
- Polycarbonate dome and reinforced nylon base
- Five-year warranty



LP800-R



Model	Description	List Price
LP800-R	Dual level Solaris® beacon, Red LED	\$450.00
LP800-A	Dual level Solaris® beacon, Amber LED	450.00
LP800-B	Dual level Solaris® beacon, Blue LED	450.00
LP800C-R	Dual level Solaris® beacon, Clear dome, Red LED	450.00
LP800C-A	Dual level Solaris® beacon, Clear dome, Amber LED	450.00
LP800C-B	Dual level Solaris® beacon, Clear dome, Blue LED	450.00

Accessory

LP800-BASE	Din Mount	99.00
------------	-----------	-------

NOTE

- Visit www.fedsig.com to view LP800 flash patterns

Pro LED Beacon

- Single and dual color versions available
- Solaris LED reflector technology
- FSLink® syncing technology
- Multi-voltage, 12/24 VDC
- Built-in permanent/1-inch pipe mount aluminum die-cast base
- Five-year warranty



300T MPC-R

Available Summer 2018



Model	Description	List Price
Permanent/1-inch Pipe mount, Single color, tall dome		
300TMP-A	Amber dome, Amber LEDs	\$425.00
300TMP-B	Blue dome, Blue LEDs	425.00
300TMP-G	Green dome, Green LEDs	450.00
300TMP-R	Red dome, Red LEDs	425.00
300TMP-W	Clear dome, White LEDs	425.00
300TMPC-A	Clear dome, Amber LEDs	425.00
300TMPC-B	Clear dome, Blue LEDs	425.00
300TMPC-G	Clear dome, Green LEDs	450.00
300TMPC-R	Clear dome, Red LEDs	425.00
Permanent/ 1-inch Pipe mount, Dual color, tall dome		
320TMP-AB	Clear dome, Amber/Blue LEDs	475.00
320TMP-AG	Clear dome, Amber/Green LEDs	500.00
320TMP-AR	Clear dome, Amber/Red LEDs	475.00
320TMP-AW	Clear dome, Amber/White LEDs	475.00

Directional Warning Features Comparison

	CN SignalMaster™	Latitude™ - SignalMaster™	VPX SignalMaster	Escape 72" SignalMaster
Available Lengths (inches)	16" and 31"	24", 32" and 48"	20", 31", 42, 51"	72"
Number of Light heads	4 and 8	6 and 8	8	8
Number of LEDs per Light head*	6, 12, 18	3	8	12
Solaris® LED Reflectors	•	•	•	•
ROC (Reliable Onboard Circuitry™)	•	•		
Multicolor LED	•			
FS Convergence Network	•			
8-wire SignalMaster™ control	•		•	•
4-wire SignalMaster™ control		•		
LED SignalMaster	•	•	•	•
LED Takedowns	•			
LED Flood Lighting	•			
Dimming	•			
Clear lens Available	•	•	•	•
Color lens Available			•	•
LED Warranty (years)	5	5	5	5
Online configurator	•			

NOTE

* Number of LEDs determined by color combinations and model

Effective April 1, 2018

CN SignalMaster™



- LED warning light with SignalMaster directional capability
- SpectraLux® multicolor capability provides “all-white-mode” for area lighting or “Amber-override” for directional lighting
- Four- and eight-head models
- Compatible with FS Convergence Network for “plug-and-play” installation and programming
- Optional serial interface module for use in traditionally-wired applications
- Front models utilize wide-angle reflectors
- Rear models utilize narrow-angle reflectors
- All White mode provides impressive area light for additional safety
- LEDs available in Amber, Blue, Green, Red or White
- Solaris® LED reflector technology for better optical efficiency and superior off-axis warning
- Patented ROC (Reliable Onboard Circuitry™) technology
- Five-year warranty



Model	Description	List Price
4-Head Rear Models, with interface module		
CNSM4R-3433618	(4) Amber LED reflectors, with interface module	\$520.00
CNSM4R-3433609	(4) Amber/Red LED reflectors, with interface module	700.00
4-Head Rear Models, without interface module		
CNSM4R-2657756	(4) Amber LED reflectors, without interface module	450.00
CNSM4R-2657767	(4) Amber/Red LED reflectors, without interface module	630.00
8-Head Rear Models, with interface module		
CNSM8R-3433621	(8) Amber LED reflectors, with interface module	870.00
CNSM8R-3433627	(8) Amber/Red LED reflectors, with interface module	1,230.00
8-Head Rear Models, without interface module		
CNSM8R-2654044	(8) Amber LED reflectors, without interface module	800.00
CNSM8R-2657764	(8) Amber/Red LED reflectors, without interface module	1,160.00
Split 8-Head Rear Models, with interface module		
CNSM2X4R-3493521	(8) Amber LED reflectors, with interface module	870.00
CNSM2X4R-3603262	(6) Amber LED reflectors, (2) red reflectors, with interface module	870.00
CNSM2X4R-3603252	(8) Amber/Red LED reflectors, with interface module	1,230.00
Split 8-Head Rear Models, without interface module		
CNSM2X4R-3493515	(8) Amber LED reflectors, without interface module	800.00
CNSM2X4R-3590662	(8) Amber/Red LED reflectors, without interface module	1,160.00
Accessories and Kits		
CNSM-RBK1	Mount kit for installing CN SignalMaster in 2017 Ford Police Utility, internal use only	30.00
CNSM-UM	Universal mount for installing CN SignalMaster, internal/external use	50.00
Z8583446E	Replacement serial interface module	73.00
Z1751531A	Splitter for network cables	49.00
320310	Kit, bracket, flush mount system	39.00
320320	Kit, bracket, double "L" mount	45.00
320330	Kit, bracket, system mount	55.00
320340	Kit, bracket, universal vehicle mount	114.00
320350	Kit, bracket, foot adaptor	33.00
SLB-001	Kit, Long L-bracket	20.00
SLB-002	Kit, Short L-bracket	20.00
SLB-4SHRD	Kit, 4-head shroud, CN SignalMaster or Latitude	25.00
SLB-8SHRD	Kit, 8-head shroud, CN SignalMaster or Latitude	30.00

HOW TO ORDER

Choose one of the popular models above, customize your own with our online configurator or contact a local Federal Signal representative or distributor.



4 Head – Rear of Vehicle



CNSM4R-3433609 (with interface module)
CNSM4R-2657767 (without interface module)

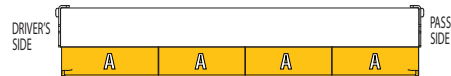

CNSM4R-3433618 (with interface module)
CNSM4R-2657756 (without interface module)

8 Head – Rear of Vehicle

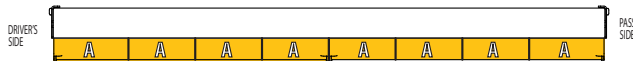

CNSM8R-2654044 (without interface module)
CNSM8R-3433621 (with interface module)



CNSM8R-2657764 (without interface module)
CNSM8R-3433627 (with interface module)

Split 8 Head – Rear of Vehicle

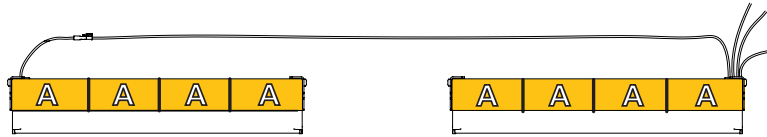

CNSM2X4R-3493515 (without interface module)
CNSM2X4R-3493521 (with interface module)

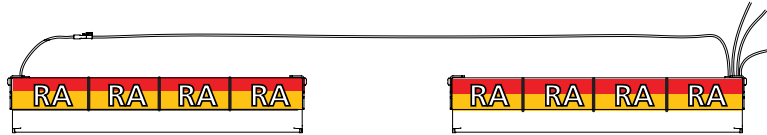

CNSM2X4R-3590662 (without interface module)
CNSM2X4R-3603252 (with interface module)

CN SignalMaster Brackets and Shrouds

320310	320320	320330	320340	320350	SLB-4SHRD
\$39.00	\$45.00	\$55.00	\$114.00	\$33.00	\$25.00
SLB-8SHRD	CNSM-RBK1	CNSM-UM	SLB-001	SLB-002	
\$30.00	\$30.00	\$50.00	\$20.00	\$20.00	

Effective April 1, 2018

Latitude™ SignalMaster™



- Available in six- or eight-head models
- Both interior and exterior mounting brackets are available; compatible with Federal Signal's SignalMaster brackets
- Each model includes left, right and center-out warning signals, and one warn pattern
- Includes Federal Signal economy SignalMaster controller
- SAE J845 Class 1, CAC Title 13 Class B
- Solaris® LED reflector technology for better optical efficiency and superior off-axis warning
- Patented ROC (Reliable Onboard Circuitry™) technology
- Five-year warranty



Model	Description	List Price
6-head, 24.2" model		
SL6S-A	(6) Amber LED reflectors, A-A-A-A-A-A, SignalMaster Economy Controller, 30-ft cable	\$499.00
8-head, 31.6" model		
SL8S-A	(8) Amber LED reflectors, A-A-A-A-A-A-A-A, SignalMaster Economy Controller, 30-ft cable	559.00
SL8S-A-50	(8) Amber LED reflectors, A-A-A-A-A-A-A-A, SignalMaster Economy Controller, 50-ft cable	624.00
8-head, 48" model		
SL8S-A48	(8) Amber LED reflectors, A-A-A-A-A-A-A-A, SignalMaster Economy Controller, 30-ft cable	635.00
SL8S-A48-50	(8) Amber LED reflectors, A-A-A-A-A-A-A-A, SignalMaster Economy Controller, 50-ft cable	675.00
Accessories and Kits		
320310	Kit, bracket, flush mount system	39.00
320320	Kit, bracket, double "L" mount	45.00
320330	Kit, bracket, system mount	55.00
320340	Kit, bracket, universal vehicle mount	114.00
320350	Kit, bracket, foot adaptor	33.00
SLB-001	Kit, Long L-bracket	20.00
SLB-002	Kit, Short L-bracket	20.00
SLB-6SHRD	Kit, 6-head shroud, Latitude only	25.00
SLB-8SHRD	Kit, 8-head shroud, CN SignalMaster or Latitude	30.00

Latitude Brackets and Shrouds									
320310	\$39.00	320320	\$45.00	320330	\$55.00	320340	\$114.00	320350	\$33.00
		SLB-6SHRD	\$25.00						
SLB-001	\$20.00	SLB-002	\$20.00	SLB-8SHRD	\$30.00				

VPX SignalMaster™



- LED directional warning light
- Utilizes Viper® EXT light heads with eight LEDs each
- Eight-head models available in 42" and 51" lengths, six-head models available in 31" lengths, and four-head models available in 20" length
- Extrusion designed to block sunlight
- Solaris® LED reflector technology for better optical efficiency and superior off-axis warning
- Compatible with Federal Signal's SignalMaster controllers
- Five-year warranty



Model	Description	List Price
320810-RB	42", (8) lamp, 30-ft cable, R-A-A-A-A-A-A-B	\$1,455.00
320810-RAR	42", (8) lamp, 30-ft cable, R-A-A-A-A-A-A-R	1,569.00
320810-BAB	42", (8) lamp, 30-ft cable, B-A-A-A-A-A-A-B	1,455.00
320842	20", (4) lamp, 30-ft cable, A-A-A-A	881.00
320852	31", (6) lamp, 15-ft cable, A-A-A-A-A-A	1,226.00
320862	31", (6) lamp, 30-ft cable, A-A-A-A-A-A	1,246.00
320866	31", (6) lamp, 60-ft cable, A-A-A-A-A-A	1,432.00
320872	42", (8) lamp, 15-ft cable, A-A-A-A-A-A-A-A	1,523.00
320882	42", (8) lamp, 30-ft cable, A-A-A-A-A-A-A-A	1,549.00
320886	42", (8) lamp, 60-ft cable, A-A-A-A-A-A-A-A	1,732.00
320892	51", (8) lamp, 30-ft cable, A-A-A-A-A-A-A-A	1,549.00
320893	51", (8) lamp, 50-ft cable, A-A-A-A-A-A-A-A	1,732.00

Common Replacement Parts

Z8613194A-01	Replacement module, Amber LEDs with Amber lens	299.00
Z8613194A-02	Replacement module, Blue LEDs with Blue lens	299.00
Z8613194A-03	Replacement module, Red LEDs with Red lens	299.00
Z8613194A-04	Replacement module, Amber LEDs with Clear lens	299.00
Z8613194A-05	Replacement module, Blue LEDs with Clear lens	299.00
Z8613194A-06	Replacement module, Red LEDs with Clear lens	299.00

Escape 72" SignalMaster™

- Solaris® LED reflector technology for better optical efficiency and superior off-axis warning
- Left, right, center-out and flashing warning signals
- Eight 6x4 QuadraFlare® LED reflectors provide superior light intensity
- Twelve high-powered LEDs in each QuadraFlare® reflector
- Available with Amber or Clear domes
- Compatible with Federal Signal's SignalMaster™ controllers
- Five-year warranty



Model	Description	List Price
ELX72-SM8	(8) Amber 6x4 QuadraFlare LED reflectors, Amber domes	\$3,225.00
ELX72-SM8-C	(8) Amber 6x4 QuadraFlare LED reflectors, Clear domes	3,225.00

SignalMaster™ Controllers

- Controls six or eight lamp SignalMasters
- Installer selectable flash patterns
- Tactile membrane keypad



330104-SB



331105-SB

Model	Description	List Price
330104-SB	Six or eight-lamp, 12 or 24V (multiple installer-selectable flash patterns, fuse protected)	\$262.00
331105-SB	Heavy Duty six or eight-lamp, 12 or 24V (slide switch, multiple installer-selectable flash patterns, heavy duty ground, fuse protected, controls two SignalMasters simultaneously)	319.00

Common Replacement Parts

Z140325A-13	Plug, controller 330105	52.00
Z8536C1041A	Knob	16.00

Effective April 1, 2018

Commander® Series



- Generates 15 K or 20 K lumens of super bright white light
- Available in 12/24 VDC, 120 VAC, or 240 VAC
- Regardless of power source - same high-powered light output
- Slimmest LED lamp head profile in the industry
- Innovative cooling fins provide higher efficiency and more light
- Advanced lens and arrangement of LEDs generate a uniform flood and spot combination light pattern
- Instant-on at full intensity
- "Sure Grip" handle stays cool to the touch when holding lamp-head
- White bezel standard, Chrome or Black bezel is optional (select models)
- Five-year warranty

Commander Series have a list pricing and discount structure separate from the other products detailed in this catalog. This page is provided as a model number reference only. For specific pricing information, view its separate price list on our website.

Model #	Voltage	Lumens	On/Off Switch	Pole Mounts		Pole Option	Other Options					
				Side Mount/ Push-Up Pole	Side Mount/ Pull-Up Pole		Fixed Top Mount	Tripod	Portable Base	Quick Release Bracket	AC Plug Type	
COM120	120 VAC	20K										
COM120-570	120 VAC	20K					-570					
COM120-ON-530	120 VAC	20K	-ON	-530								
COM120-ON-530SW	120 VAC	20K	-ON	-530		SW						
COM120-ON-540SW	120 VAC	20K	-ON		-540	SW						
COM120-ON-600-603	120 VAC	20K	-ON					-600			-603	-P3
COM120-ON-642-603	120 VAC	20K	-ON					-642			-603	-P3
COM120-ON-656-603-P1	120 VAC	20K	-ON					-656			-603	-P1
COM120-ON-700-P1	120 VAC	20K	-ON						-700			-P1
COM15K	12/24 VDC	15K										
COM15K-530	12/24 VDC	15K		-530								
COM15K-530SW	12/24 VDC	15K		-530		SW						
COM15K-540	12/24 VDC	15K			-540							
COM15K-540SW	12/24 VDC	15K			-540	SW						
COM20K	12/24 VDC	20K										
COM20K-530SW	12/24 VDC	20K		-530		SW						
COM20K-ON	12/24 VDC	20K	-ON									
COM20K-ON-530SW	12/24 VDC	20K	-ON	-530		SW						
COM20K-ON-540TW	12/24 VDC	20K	-ON		-540							

NOTE

- Commander Series are in the price group M02. Price file can be found on www.fedsig.com

PART NUMBER KEY

- 600: standard/full size tripod (72" high)
- 642: short tripod (45" high)
- 656: medium tripod (58" high)
- P1: 5-15 straight (household type) plug
- P3: L5-15 3-prong twist lock plug

Commander® Plus & Plus-S Series



- Generates 28K lumens of super bright white light
- Available in 12/24 VDC, 120 VAC, or 240 VAC
- Regardless of power source - same high-powered light output
- Slimmest LED lamp head profile in the industry
- Innovative cooling fins provide higher efficiency and more light
- Advanced lens and arrangement of LEDs generate a uniform flood and spot combination light pattern
- Instant-on at full intensity
- Commander Plus-S allows user to select spot (14K lumens) or flood (14K lumens) light patterns or 28K lumens spot/flood combination
- "Sure Grip" handle stays cool to the touch when holding lamphead
- White bezel standard, Chrome or Black bezel is optional (select models)
- Five-year warranty

Commander Series have a list pricing and discount structure separate from the other products detailed in this catalog. This page is provided as a model number reference only. For specific pricing information, view its separate price list on our website.

Model #	Voltage	Lumen	On/Off Switch	Side Mount/ Push-Up Pole	Pole Option	Other Mounts		Other Options	
					Raised Pole Indicator	Fixed Top Mount	Tripod	Quick Release Bracket	AC Plug Type
COMX-120	120 VAC	28K							
COMX-120-570	120 VAC	28K					-570		
COMX-120-ON-530	120 VAC	28K	-ON	-530					
COMX-120-ON-530SW	120 VAC	28K	-ON	-530	SW				
COMX-120-ON-600-603-P3	120 VAC	28K	-ON				-600	-603	-P3
COMX-120-ON-642-603	120 VAC	28K	-ON				-642	-603	-P3
COMX-DC	12/24 VDC	28K							
COMX-DC-530	12/24 VDC	28K		-530					
COMX-DC-530SW	12/24 VDC	28K		-530	SW				
COMX-DC-570	12/24 VDC	28K					-570		
COMX-DC-ON-530	12/24 VDC	28K	-ON	-530					
COMX-S-120	120 VAC	28K*							
COMX-S-120-570	120 VAC	28K*					-570		
COMX-S-120-ON-530	120 VAC	28K*	-ON	-530					
COMX-S-DC	12/24 VDC	28K*							
COMX-S-DC-570	12/24 VDC	28K*					-570		
COMX-S-DC-ON-530	12/24 VDC	28K*	-ON	-530					

NOTES

- Commander Plus & Plus-S Series are in the price group M02. Price file can be found on www.fedsig.com
- *COM-X models allow user to select spot (14K) and/or flood (14K)

Effective April 1, 2018

Commander® M Series

- Generates 14K lumens of super bright white light
- Available in 12/24 VDC, 120 VAC, or 240 VAC
- Compact lamphead design - only 8 3/4-inch wide by 3 1/4-inch deep
- Slimmest LED lamp head profile in the industry
- Advanced lens and arrangement of LEDs generate a uniform flood and spot combination light pattern
- Instant-on at full intensity
- White bezel standard, Chrome or Black bezel is optional (select models)
- Five-year warranty



Commander Series have a list pricing and discount structure separate from the other products detailed in this catalog. This page is provided as a model number reference only. For specific pricing information, view its separate price list on our website.

Model #	Voltage	Lumen	On/Off Switch	Pole Mounts		Other Mounts
				Side Mount/ Push-Up Pole	Side Mount/ Pull-Up Pole	Fixed Top Mount
COMMS-120	120 VAC	14K				
COMMS-120-570	120 VAC	14K				-570
COMMS-120-ON-530	120 VAC	14K	-ON	-530		
COMMS-120-ON-540-H	120 VAC	14K	-ON		-540	
COMMS-DC	12/24 VDC	14K				
COMMS-DC-570	12/24 VDC	14K				-570
COMMS-DC-ON-530	12/24 VDC	14K	-ON	-530		

NOTE
 • Commander M Series are in the price group M02. Price file can be found on www.fedsig.com

Commander® LC Series

- Generates 11K or 20K lumens of super bright white light (15K for recessed mount only)
- Available in 12/24 VDC
- Compact lamphead on 11K lumen models
- Uniform high quality white light with the widest light pattern
- Parabolic reflector & lens designed to direct all the light onto the scene
- Instant-on at full intensity
- Five-year warranty



COMLC11K-570



COMLC20K

Commander Series have a list pricing and discount structure separate from the other products detailed in this catalog. This page is provided as a model number reference only. For specific pricing information, view its separate price list on our website.

Model #	Lumen	On/Off Switch	Pole Mounts		Pole Option	Other Mounts	
			Side Mount/ Push-Up Pole	Side Mount/ Pull-Up Pole	Raised Pole Indicator	Fixed Top Mount	Recessed Mount
COMLC11K	11K						
COMLC11K-530-H	11K		-530				
COMLC11K-540-H	11K			-540			
COMLC11K-570	11K					-570	
COMLC11K-570-ON	11K	-ON				-570	
COMLC15K-210	15K						-210
COMLC20K	20K						
COMLC20K-530SW-H	20K		-530		SW		
COMLC20K-540TW-H	20K			-540			
COMLC20K-570	20K					-570	

NOTE
 • Commander LC Series are in the price group M02. Price file can be found on www.fedsig.com

Commander® SB Series

- Generates 7K lumens of intense LED light
- Available in 12/24 VDC
- Built tough for long life in the harshest environments
- Versatile design offers multiple mounting options
- Offers three different light patterns
 - Spot: a focused and concentrated long range light beam for illuminating objects in the distance
 - Flood: widest pattern of light that is perfect for evenly illuminating the work area
 - Trapezoid: Wider than a spot and longer than a flood; ideal as an all-purpose light or for mounting on front of vehicle for increased visibility while driving
- White housing standard, Black housing is optional
- Available with optional on/off switch
- Five-year warranty



COMSB-FLD-YM



COMSB-TRP-CD

Commander Series have a list pricing and discount structure separate from the other products detailed in this catalog. This page is provided as a model number reference only. For specific pricing information, view its separate price list on our website.

Model #	Lumen	Light Pattern			Mounts		
		Flood	Spot	Trapezoid	Pedestal	Yoke	None
COMSB-FLD-CD	7K	FLD			-CD		
COMSB-FLD-NM	7K	FLD					-NM
COMSB-FLD-YM	7K	FLD				-YM	
COMSB-SPT-CD	7K		SPT		-CD		
COMSB-SPT-NM	7K		SPT				-NM
COMSB-SPT-YM	7K		SPT			-YM	
COMSB-TRP-CD	7K			TRP	-CD		
COMSB-TRP-NM	7K			TRP			-NM
COMSB-TRP-YM	7K			TRP		-YM	

- NOTES**
- Commander SB Series are in the price group M02. Price file can be found on www.fedsig.com
 - Order with -BLA for Black housing
 - Order with -ON for on/off switch

Commander® Series Surface Mount Lights

- Slimmest profile surface mount - only 1 3/4-inch
- Generates up to 20K lumens of super bright White light, depending on the model
- Available in 12/24 VDC or 120 VAC
- Chrome bezel standard, Black bezel is optional
- Easy to install, no panel cut-out needed on VDC models
- Five-year warranty



COM15K-260



COM7K-900

Commander Series have a list pricing and discount structure separate from the other products detailed in this catalog. This page is provided as a model number reference only. For specific pricing information, view its separate price list on our website.

Model	Description
COM7K-900	Commander, 7K lumen, 12/24 VDC, low-profile surface mount light, Chrome bezel
COM120-260	Commander, 15K lumen, 120 VAC, low-profile surface mount light, Chrome bezel
COM15K-260	Commander, 15K lumen, 12/24 VDC, low-profile surface mount light, Chrome bezel
COMX-DC-260	Commander Plus, 20K lumen, 12/24 VDC, low-profile surface mount light, Chrome bezel

- NOTE**
- Commander Series are in the price group M02. Price file can be found on www.fedsig.com

Effective April 1, 2018

Commander® Series Brow Mount Lights

- Generates up to 28K lumens of super bright white light, depending on model
- Available in 12/24 VDC, 120 VAC, or 240 VAC
- White bezel standard, Chrome or Black bezel is optional (select models)
- Five-year warranty



Commander Series have a list pricing and discount structure separate from the other products detailed in this catalog. This page is provided as a model number reference only. For specific pricing information, view its separate price list on our website.

Model #	Voltage	Lumen	Brow Mount Type			Vehicle Chassis
			Contour	Universal	Flat	
COM120-800-08	120 VAC	20K	-800			Rosenbauer
COM15K-800-03	12/24 VDC	15K	-800			Spartan
COM15K-800-05	12/24 VDC	15K	-800			KME
COM15K-800-08	12/24 VDC	15K	-800			Rosenbauer
COM15K-800-10	12/24 VDC	15K	-800			Ferrara
COM15K-830	12/24 VDC	15K		-830		Universal
COM15K-850	12/24 VDC	15K			-850	Flat
COM20K-800-05	12/24 VDC	20K	-800			KME
COM20K-830	12/24 VDC	20K		-830		Universal
COMLC11K-850	12/24 VDC	11K			-850	Flat
COMLC20K-800-08	12/24 VDC	20K	-800			Rosenbauer
COMX-120-800-08	120 VAC	28K	-800			Rosenbauer
COMX-S-DC-800-08	12/24 VDC	28K	-800			Rosenbauer

NOTES

- Commander Series are in the price group M02. Price file can be found on www.fedsig.com
- Additional vehicle specific contour mounts available by request

Commander® Series 550 Work Lights

- Plastic housing work light
- Effective flood light solution
- Adjustable vertical and horizontal mounts
- Round and square versions
- Stainless steel hardware kit and u-bracket included
- 12/24 VDC
- Three-year warranty



COM550-SQ



COM550-RND

Available Summer 2018

Model	Description	List Price
550 Lumen Models		
COM550-RND	550 Lumen, Round	\$50.00
COM550-SQ	550 Lumen, Square	50.00

Commander® Series 750/1200 Work Lights

- High powered LED work light
- Effective flood light solution
- Adjustable vertical and horizontal mounts
- Vibration resistant construction
- Round and square versions
- Stainless steel hardware kit and u-bracket included
- 12/24 VDC
- Three-year warranty



COM1200-SQ



COM1200-RND

Model	Description	List Price
1200 Lumen Models		
COM1200-RND	1200 Lumen, Round	\$105.00
COM1200-SQ	1200 Lumen, Square	105.00
750 Lumen Models		
COM750-RND	750 Lumen, Round	65.00
COM750-SQ	750 Lumen, Square	65.00



COM1200-RND mounted on push bumper

Effective April 1, 2018

Wireless VisiBeam®/VisiBeam®

- High-power spotlight for superior work area illumination
- Ergonomically designed wireless transmitter operates at over 100-ft (Wireless VisiBeam®)
- Up to four transmitters programmable to operate one light (Wireless VisiBeam®)
- Graduated start for pinpoint light beam placement
- Continuous 360-degree horizontal and 140-degree vertical adjustment
- Three-year warranty



Model	Description	List Price
Wireless VisiBeam		
12 VDC, 100 W, wireless controller		
620200	Permanent mount	\$449.00
620201	Magnetic mount with cigarette lighter plug	491.00
24 VDC, 65 W wireless controller		
620202	Permanent mount	462.00
VisiBeam		
12 VDC, 55 W		
620102	55 W, 12 VDC, adjustable spotlight surface mount	394.00
24 VDC, 65 W		
620104	65 W, 24 VDC, adjustable spotlight, permanent mount	394.00
12 VDC, 100 W		
620122	100 W, 12 VDC, adjustable spotlight, surface mount	399.00
620122-40	100 W, 12 VDC, adjustable spotlight, surface mount, 40-ft cable	420.00
620142	100 W, 12 VDC, adjustable spotlight, magnetic mount with cord and cigarette plug	444.00
Common Replacement Parts		
620502	Bulb, 12 VDC, 100 W, for models 620122, 620142, 620152, 620200 and 620201	16.00
620504	Bulb, 24 VDC, 65 W, for models 620104 and 620202	27.00
620510	Bulb, 12 VDC, 55 W, for model 620102	15.00
448500-05	Dome, Clear	23.00
Z146903B	Cable assembly, 25-ft	27.00
Z8433039B	Remote control	149.00
Z8422B399A-01	Motor, 12 VDC	45.00
Z8422528A	Motor, 24 VDC	45.00
Z8433113A	Transmitter, wireless	162.00

FireFly Compartment Lights



- Ultra bright 650 lumens light output
- Available in 12/24 VDC
- Four white LEDs in waterproof anodized aluminum housing
- Can be mounted in any orientation and on any flat surface for compartments, panels and under-body applications
- Instant-on at full intensity
- Available in flood lens for wider illumination (perfect for under vehicle) or focused lens to reduce glare (perfect for compartments)
- Five-year warranty

Commander Series have a list pricing and discount structure separate from the other products detailed in this catalog. This page is provided as a model number reference only. For specific pricing information, view its separate price list on our website.z

Model	Description
COMFF100	FireFly, 650 lumen, 12/24 VDC, focused lens, surface mount
COMFF110	FireFly, 650 lumen, 12/24 VDC, flood lens, surface mount
NOTE	
• FireFly are in the price group M02. Price file can be found on www.fedsig.com	

Commander® Series Flex Lights



- Interior mounted flexible strip lighting
- 1/2-inch wide
- 3M® acrylic foam tape on back for easy installation; mounting clips and screws included
- Three-year warranty

Available Summer 2018

Model	Description	List Price
COMFLEX-9	9", flexible compartment strip light, LED	\$18.00
COMFLEX-18	18", flexible compartment strip light, LED	27.00
COMFLEX-27	27", flexible compartment strip light, LED	36.00
COMFLEX-36	36", flexible compartment strip light, LED	48.00
COMFLEX-45	45", flexible compartment strip light, LED	60.00
COMFLEX-54	54", flexible compartment strip light, LED	72.00
COMFLEX-63	63", flexible compartment strip light, LED	84.00

Commander® 5" LED Dome Light

- Low-profile surface mount rectangular dome/compartment light - less than 3/4-inch thick
- Durable polycarbonate Clear lens
- 12 VDC
- 540 raw lumen output, 380 effective lumen output
- Five-year warranty



Model	Description	List Price
COMINT5-W	Dome light, 5" rectangle, White LEDs, Clear lens	\$30.00

Effective April 1, 2018

Commander® 8" LED Dome Lights

- 8-inch round interior lights available in multiple LED colors and housing types
- Direct replacement for eight-inch halogen or incandescent lamps utilizing standard industry hole patterns and cutout dimensions. LED models eliminate the high cost of lamp replacement associated with halogen or incandescent lamps
- Models available with Chrome and White housings, including snap-in models
- Hi-Lo intensity inputs
- Input Voltage: 12 VDC
- Low amperage consumption (1.72 High/.213 Low)
- Certified to meet KKK-1822F requirements when properly installed
- Five-year warranty



Model	Description	List Price
COM8PTC	8" Round, 18 White LEDs, Diffusing lens, Chrome Housing	\$168.00
COM8PTSC	8" Round, 18 White LEDs, Diffusing lens, Chrome snap-in housing	168.00
COM8PTSW	8" Round, 18 White LEDs, Diffusing lens, White snap-in housing	168.00
COM8PT3B6WC	8" Round, 6 White and 3 Blue LEDs, Diffusing lens, Chrome housing	300.00
COM8PT3B6WW	8" Round, 6 White and 3 Blue LEDs, Diffusing lens, White housing	300.00
COM8PT3R6WC	8" Round, 6 White and 3 Red LEDs, Diffusing lens, Chrome housing	300.00
COM8PT3R6WW	8" Round, 6 White and 3 Red LEDs, Diffusing lens, White housing	300.00
COM8PT6C	8" Round, 6 White LEDs, Diffusing lens, Chrome housing	130.00
COM8PT6W	8" Round, 6 White LEDs, Diffusing lens, White housing	130.00

Commander® Illumination Lights

- Multi-purpose surface mount lights; small size allows for various mounting locations on vehicle
- Meets NFPA step light spec (13.10.3) and is available in a surface mount and 45-degree angle mount
- All models are fully encapsulated to prevent any moisture issues
- All models include a Chrome flange and mounting gasket
- Five-year warranty



Model	Description	List Price
White Illumination light, Surface Mount		
COM1LC-W	3-LED light head, Chrome flange, White	\$40.00
COM145LC-W	3-LED light head, 45-degree mount, Chrome flange, White	42.00

Commander® 3" Compartment Lights

- Standard 3-inch round surface mount compartment lights with an aluminum base
- Surface mount alleviates the need to do full body cut-outs
- Low-profile design allows for versatile mounting options
- All models include bolt or adhesive mount for added flexibility in mounting
- Two-color compartment lights allow for separate control of colors
- Red LED compartment lights are ideal for improved nighttime vision in compartments
- Chrome flange and rubber grommet available.
- Five-year warranty



Model	Description	List Price
Single Color, Compartment Light, Surface Mount		
COM3SWC	6 LED, 3" round light, White LED, Clear lens	\$70.00
COM3SRR	6 LED, 3" round light, Red LED, Red lens	70.00
Two Color, Compartment Light, Surface Mount		
COM3BWC	6 LED, 3" round light, Blue/White LED, Clear lens, Separate control of colors	78.00
COM3SRWC	6 LED, 3" round light, Red/White LED, Clear lens, Separate control of colors	78.00
Accessories and Kits		
COM3FLANGEC	3" round Chrome flange for COM3 lights	13.00
COM3GROMMET	Kit, Grommet for COM3 lights	8.00

SignalTech® Compartment Lights

- Reflector cell technology enhances brightness and reduces sunlight washout
- Enhanced lens design for a uniform pattern
- Solid-state components are potted to withstand rugged road conditions
- Three-year warranty



Model	Description	List Price
607141-05	Round, 4" White LED compartment lights (kit includes LED light head, Black mounting grommet and sealed wire harness)	\$134.00
607141-05GRAY	Round, 4" White LED compartment lights, (kit includes LED light head, Gray mounting grommet and sealed wire harness)	134.00
Accessories and Kits		
605501-02SB	6" oval flashing LED light head, Amber; -04(Red)	85.00
605520SB	Kit, rubber mounting grommet, 4" round	6.00
605510SSG	Kit, rubber mounting grommet, 6" oval	6.00
605523-02SB	4" round flashing LED light head, Amber; -03(Blue); -04(Red)	82.00
605500SB	Sealed wire harness for flashing LED light heads	9.00
607109SB	Sealed wire harness for S/T/T and Turn LED light heads	9.00
605530SB	2.5" round mounting grommet	6.00

Effective April 1, 2018

Evacuator® Back-up Alarms



- Back-up alarms have a wide range of decibel and voltage options
- Solid-state design protects and resists the effects of vibration
- Sealed unit protects internal components from moisture and contaminants
- 12/48 VDC
- Three-year warranty

Model	Description	List Price
Dual function, 12/48 V		
210330SSG	87 dB	\$45.00
210331SSG	97 dB	44.00
210333SSG	107 dB	47.00
210335SSG	112 dB	68.00

2012 Series Back-up Alarms

- Available in 87 dB(A), 97 dB(A), and 102 dB(A) models with wires or stud terminals
- Built-in universal mounting bracket (with industry-standard 3.25-inch centers) and self-grounding strap (on “-S” models) eases installation
- Alarms operate at 12/24 VDC drawing only 0.5 A
- Meet SAE J994, CE, OSHA, and MSHA requirements
- Steam-cleanable and pressure-washable
- Epoxy encapsulation protects against vibration, as well as debris and moisture
- Three-year warranty



Model	Description	List Price
210238-S	87 dB(A), 12/24 VDC, SAE J994 Type D, stud terminals	\$27.00
210238-W	87 dB(A), 12/24 VDC, SAE J994 Type D, wires	27.00
210239-S	97 dB(A), 12/24 VDC, SAE J994 Type C, stud terminals	27.00
210239-W	97 dB(A), 12/24 VDC, SAE J994 Type C, wires	27.00
210240-S	102 dB(A), 12/24 VDC, SAE J994 Type F, stud terminals	27.00
210240-W	102 dB(A), 12/24 VDC, SAE J994 Type F, wires	27.00

Reverse Camera/Monitor Systems

- All cameras are high-resolution, color Sony CCD cameras
- TFT-LCD color monitors available in 5.6-inch or 7.0-inch
- Most cameras equipped with automatic day/night sensor and infrared LEDs for night vision
- Park assist lines in monitor
- Multiple camera cable lengths available: 16.5-ft, 33-ft, 49-ft and 65.5-ft
- Wide operating temperature range for all cameras: -22°F to 149°F
- Multi-voltage capability (12/24 VDC)
- Two-year warranty



Model	Description	List Price
Systems		
CAMSET56-NTSC-2	5.6" Monitor with two camera inputs, (1) standard rear-view Black camera, and (1) 65.5-ft camera-to-monitor extension cable	\$685.00
CAMSET70-NTSC4B	7.0" Monitor with four camera inputs, intelligent split screen capability, (1) standard rear-view Black camera, and (1) 65.5-ft camera-to-monitor extension cable, and (1) CAMBRK-HD bracket	815.00
Monitors - Camera cables not included		
CAMLCD-INT-56	5.6" TFT-LCD monitor with two camera inputs	465.00
CAMLCD-INT-70-B	7.0" TFT-LCD monitor with four camera inputs and intelligent split-screen capability	555.00
CAMLCD-MIR	4.3" TFT-LCD rear-view mirror monitor with two camera inputs	345.00
Cameras - Camera cables not included		
CAMCCD-BALLNTSC	Standard rear-view CCD camera with photosensor and 16 infrared LEDs for night vision, microphone, IP68	220.00
CAMCCD-CHMSL	CHMSL brake light with built-in back up camera	399.00
CAMCCD-COMREAR	Compact mirroring CMOS camera, 8 infrared LEDs and microphone	220.00
CAMCCD-DOMENTSC	Dome CCD camera with photosensor and 18 infrared LEDs for night vision, microphone, IP65	220.00
CAMCCD-FLS2NTSC	Bullet/flush-mount CCD camera with photosensor and 10 infrared LEDs for night vision, IP68	220.00
CAMCCD-FLSHNTSC	Bullet/flush-mount CCD camera, IP68, U-bracket included	220.00
CAMCCD-REARMIR	Mirroring CCD camera, 15 infrared LEDs and microphone	220.00
CAMCCD-REARMIR-NIR	Mirroring CCD Camera and microphone	220.00
CAMCCD-REARNTSC	Standard rear-view CCD camera with photosensor, 16 infrared LEDs, and microphone, Black	220.00
CAMCCD-SIDENTSC	Side vehicle CCD camera with photosensor, 16 infrared LEDs, and microphone, Black	220.00
Wireless Module		
CAMADP-DWL	Module, wireless link	450.00
Cables		
CAMCABLE-5	Camera-to-monitor extension cable, 16.5-ft/5-m	25.00
CAMCABLE-10	Camera-to-monitor extension cable, 33-ft/10-m	30.00
CAMCABLE-15	Camera-to-monitor extension cable, 49-ft/15-m	35.00
CAMCABLE-20	Camera-to-monitor extension cable, 65.5-ft/20-m	45.00
CAMCABLE-40	Camera-to-monitor extension cable, 131-ft/40-m	95.00
CAMCABLE-TRK	Truck/trailer camera connection kit	155.00
CAMCABLE-SHORT	Camera-to-monitor extension cable, 4-in/102-mm	15.00
Accessories and Kits		
CAMADP-EXT	Camera cable adapter for connecting two camera-to-monitor extension cables together	10.00
CAMADP-RCA-IN	System adapter for connecting external RCA to FS monitor or DVR	15.00
CAMADP-RCA-OUT	System adapter for connecting CAMCCD-XXXXNTSC to external RCA input	15.00
CAMBRK-HD	Heavy-duty monitor mount	35.00
CAMLCD-BRACKET	Replacement mounting bracket for monitor	30.00
Common Replacement Parts		
CAMADP-INT-2	Replacement wiring harness, CAMLCD-INT-56	20.00
CAMADP-INT-4	Replacement wiring harness, CAMLCD-INT-70-B	22.00

Camera Models						
						
CAMCCD-FLSHNTSC	CAMCCD-FLS2NTSC	CAMCCD-SIDENTSC	CAMCCD-REARNTSC	CAMCCD-DOMENTSC	CAMCCD-BALLNTSC	CAMLCD-MIR

Effective April 1, 2018

Atkinson Dynamics Intercoms



- Integrated filtering to reduce outside noise and interference
- Multi-volt; units operate at both 12/24 VDC
- Reliable two or three-way communication in any conditions
- Variety of options available to satisfy communications needs
- Simple to use and easy to install
- Designed and built to protect against the elements and withstand rough conditions
- Two-year warranty

Model	Description	List Price
Intercoms		
AD26-Z	Push to talk, 12/24 VDC	\$812.00
AD26-8-M44-Z	Push to talk, pre-amplifier, remote volume, 12/24 VDC, use with ADSS-25 or ADSF-25	985.00
AD26C-Z	Master intercom, push to talk, 12/24 VDC, use with hands-free intercom	929.00
AD26C-1-Z	12/24 VDC, master intercom, power audio in single cable	999.00
AD26C-7-Z	Master intercom, push to talk, microphone ready, 12/24 VDC, use with hands-free intercom	1,035.00
AD26D-Z	Hands-free intercom, defaults to talk mode, 12/24 VDC, use with master intercom	927.00
AD26D-1-Z	12/24 VDC, auxiliary intercom, use with AD26C-1-Z	1,064.00
Speakers		
ADSF-25-Z	25W, flush mount	412.00
ADSS-25-Z	25W, swivel mount	412.00
ADSV-25-Z	25W, wall mount with volume control	412.00

Basic Systems

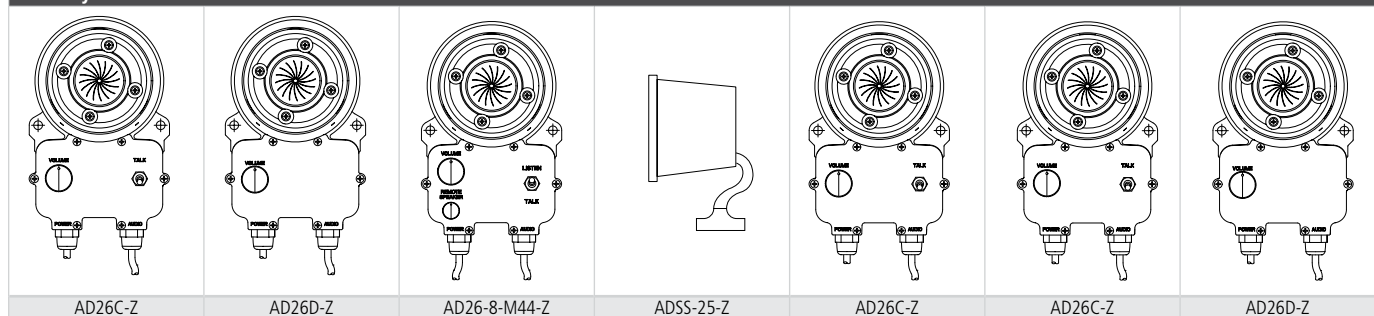

FSX Visor Light

- Provides clear identification and temporary marking for vehicles
- Slides over existing sun-visor and plugs into cigarette plug
- Detachable adapter allows the user to disconnect the FSX visor from the cigarette plug when sign is not in use
- Easy removal and storage
- Light output dimming control to avoid flashback
- No tools, brackets, or sticking materials required
- UV stable and shatterproof
- Five-year warranty



Model	Description	List Price
2030022FS	FSX Visor light, (12) Blue LEDs with "FIRE" sign, cigarette plug, 12/24 VDC	\$244.00
2030023FS	FSX Visor light, (12) Red LEDs with "FIRE" sign, cigarette plug, 12/24 VDC	244.00

Headlight/Taillight Flashers

- Vehicle-specific flashers/mounts for a variety of vehicles
- "Plug-and-Play" models allow for quick installation
- Multiple flash pattern options
- Three-year warranty

Model	Description	List Price
FHLP-IMP	Flasher, Headlight, 2006-newer, Chevrolet Impala Police Package with "plug-n-play" connectors	\$119.00
FHLP-TAH	Flasher, Headlight, 2006-2014, Chevrolet Tahoe with "plug-n-play" connectors	115.00
FHL-CHG	Flasher, Headlight, 2006-newer, Dodge Charger and Dodge Durango	86.00
FHL-HL	Flasher, Headlight, positive-side switched systems, 18" wire leads, (2) 10 A outputs, multiple flash patterns	75.00
FHL2-SC	Flasher, Headlight, 90 FPM, positive-side switched systems, high-beam override, (2) 10 A loads	79.00
FHL-TAIL	Flasher, Taillight, universal applications, 18" wire leads	80.00



FHLP-TAH



FHL-CHG



FHL-HL



FHLP-IMP



FHL-TAIL

Application Reference Chart

Vehicle	Headlight	Taillight
Ford Expedition	FHL-HL	FHL-TAIL
Ford Explorer	FHL-HL	FHL-TAIL
Chevrolet Impala Police Package	FHLP-IMP	FHL-TAIL
Chevrolet Tahoe, 2014	FHLP-TAH	FHL-TAIL
Chevrolet Tahoe, 2015-2018	FHL-CHG	FHL-TAIL
Dodge Charger, 2015-2018	FHL-CHG	FHL-TAIL
Dodge Durango, 2015-2018	FHL-CHG	FHL-TAIL
Ford Police Interceptor Sedan	N/A	FHL-TAIL
Ford Police Interceptor Utility, 2016-2018	FHL-CHG	FHL-TAIL

Effective April 1, 2018

MB1 LED Message Board

- Public safety messaging system incorporates LED message display board suitable for interior and exterior mounting, with internally mounted controller
- One controller to select from pre-determined list of messages
- Programming software allows administrator to create customized messages
- Display board utilizes 672 Amber, Blue or Green LEDs
- Display board is (LxHxD) 35.2 in x 3.0 in x 3.3 in, excluding brackets
- Three-year warranty



MB1-A

Model	Description	List Price
MB1	Public safety messaging system with Blue LED message display and controller, 12 VDC	\$2,995.00
MB1-A	Public safety messaging system with Amber LED message display and controller, 12 VDC	2,995.00
MB1-G	Public safety messaging system with Green LED message display and controller, 12 VDC	2,995.00

Accessories and Kits

MBK01	Kit for mounting MB1 to rear interior of Ford Police Interceptor Utility	10.00
MBK02	Kit for mounting MB1 to rear interior of 2015-2018 Chevy Tahoe	10.00
MBK03H	Kit for mounting MB1 message board to rear of Valor® light bars, hook mount only	10.00
MBK04	Kit for mounting MB1 to rear of Integrity®, Legend®, LPX, and Navigator® light bars (except for HotFoot® versions of these bars)	10.00
MBK05	Kit for mounting MB1 to rear of Vision® SLR light bar	10.00

Examples of pre-programmed messages

(Messages can be customized for "steady-on", scrolling, flashing, multiple lines, scroll direction, scroll speed and Bold/Normal font)



Examples of different font choices



Bold Font



Standard Font



Control head



Message creation software

Switch Controls

- Switching of up to seven auxiliary functions
- 20 A fuses and 20 A switches are standard
- Standard, high current slide switch and non-slide switch models available
- Backlit or LED function identification
- Easy installation
- Three-year warranty



Model	Description	List Price
"SW" Switch Control Panel Models		
SW1	One rocker switch	\$17.00
SW2	Two rocker switches	39.00
670132	Three rocker switches	54.00
SW30	SW30 Series, (3) 20A toggle switches on "L" bracket housing	48.00
SW200-B	4-switch box with bail bracket	227.00
SW300-B	6-switch box with bail bracket	237.00
SW400SS-B	4-switch with slide switch box and bail bracket	304.00
Toggle Switch Models		
210620SSG	Toggle switch, Black	12.00
210633SSG	Toggle switch, Chrome on metal	19.00
Accessories and Kits		
210624SSG	Single-hole switch panel for use with 1/2" diameter toggle switch	7.00

Intelli-Flash® Flashers

- Specifically designed for use with auxiliary LED lighting
- Designed to perform in a variety of applications
- Can be used to synchronize multiple light heads
- Three-year warranty



Model	Description	List Price
Intelli-Flash Series flashers (auxiliary lighting flashers - do not use for headlight or taillight applications)		
650201	(2) 6 A loads, (8) flash patterns, ground-side switching	\$108.00
650202	(4) 4 A loads, (8) flash patterns, ground-side switching	108.00
650205	(2) 10 A loads, (10) flash patterns, high-side switching	133.00
650302	(16) 2.5 loads, (20) flash patterns, NFPA or Triple K zone control, high-side switching	316.00
FA3-SC	90 FPM, (2) 10 A loads, high-side switching	35.00

Opticom®

- Infrared LED and strobe traffic pre-emption emitters
- Internal-mount and external-mount emitter available
- Some models available with mounting brackets for attachment to FS light bars
- 792 and 794 emitters covered by five-year GTT warranty
- 795 emitters covered by two-year GTT warranty



Model	Description	List Price
Opticom emitters with light bar mounting brackets		
795H-EXT-D	GTT 795H emitter/bracket for attaching to driver-side of Valor, Integrity, Vision SLR, Legend and Split Vision SLR light bars	\$1,999.00
795H-EXT-P	GTT 795H emitter/bracket for attaching to passenger-side of Valor, Integrity, Vision SLR, Legend and Split Vision SLR light bars	1,999.00
Opticom emitters		
794-AH	794 infrared LED emitter, suitable for external use	2,060.00
3M792H	792 strobe emitter, suitable for external use	2,101.00

NOTES

- Opticom emitters must be mounted behind clear domes

Effective April 1, 2018

Littlite®

- Flexible, "goose-neck" task lights that can be easily aimed exactly where you need it
- LED or halogen models
- Available with on/off switch or rheostat "dimmer" control
- 6", 12", and 18" lengths
- Includes a 24" wire length for installation
- Five-year warranty



Model	Description	List Price
LED LITTLITE MODELS		
Neck extends from top of chassis, horizontal mount		
LF12TSB-LED	12", On/Off switch control, wired base	\$130.00
LF12TS-LED	12", On/Off switch control	130.00
LF18TSB-LED	18", On/Off switch control, wired base	130.00
LF18TSB-LED-BLUE	18", On/Off switch control, wired base, Blue	130.00
LF18TS-LED	18", On/Off switch control	130.00
Neck extends from end of chassis, vertical mount		
LF12ES-LED	12", On/Off switch control	130.00
LF18ES-LED	18", On/Off switch control	130.00
HALOGEN LITTLITE MODELS		
Neck extends from end of chassis, vertical mount		
LF12ER	12", Rheostat control	75.00
LF12ERB	12", Rheostat control, wired base	75.00
LF12ESB	12", On/Off switch control, wired base	75.00
LF18ERB	18", Rheostat control, wired base	75.00
Neck extends from top of chassis, horizontal mount		
LF6MOTO	6", Switch control, wired base, motorcycle application	75.00
LF12TR	12" Rheostat control	75.00
LF12TRB	12", Rheostat control, wired base	75.00
LF18TR	18", Rheostat control	75.00
LF18TRB	18", Rheostat control, wired base	75.00
LF18TS	18", On/Off switch control	75.00
Common Replacement Parts		
Z8550250A	lamp, bi-pin	31.00
Z8550251A	Filter, Red; -01(Clear)	15.00

Voice Gun

- High-power electronic megaphone
- Lightweight; less than 4-lbs each
- Trouble free, solid-state design
- Three-year warranty



Model	Description	List Price
A12SA	16 W, 1320-ft range, requires (8) AA batteries	\$699.00

AirEL® Illuminated Thermal Identification Systems

- Allows ground and aerial crews to establish vehicle identification through illuminated numbers/letters
- The AirDek is an aerodynamic, low-profile plate that fits on the roof of SUVs to support and house identification, antennae, and communication equipment
- AirEL Thermal offers a thermal version that is visible using thermal cameras
- Weather and water proof
- No radio interference
- FCC compliant



AirEL has a list pricing and discount structure separate from the other products detailed in this catalog. This page is provided as a model number reference only. For specific pricing information, view its separate price list on our website.

Model	Description
Illuminated Characters, 20-inch Letters	
AELL-A	Illuminated letter "A" 20-inches, Blue
AELL-B	Illuminated letter "B" 20-inches, Blue
AELL-C	Illuminated letter "C" 20-inches, Blue
AELL-D	Illuminated letter "D" 20-inches, Blue
AELL-E	Illuminated letter "E" 20-inches, Blue
AELL-F	Illuminated letter "F" 20-inches, Blue
AELL-G	Illuminated letter "G" 20-inches, Blue
AELL-H	Illuminated letter "H" 20-inches, Blue
AELL-I	Illuminated letter "I" 20-inches, Blue
AELL-J	Illuminated letter "J" 20-inches, Blue
AELL-K	Illuminated letter "K" 20-inches, Blue
AELL-L	Illuminated letter "L" 20-inches, Blue
AELL-M	Illuminated letter "M" 20-inches, Blue
AELL-N	Illuminated letter "N" 20-inches, Blue
AELL-O	Illuminated letter "O" 20-inches, Blue
AELL-P	Illuminated letter "P" 20-inches, Blue
AELL-Q	Illuminated letter "Q" 20-inches, Blue
AELL-R	Illuminated letter "R" 20-inches, Blue
AELL-S	Illuminated letter "S" 20-inches, Blue
AELL-T	Illuminated letter "T" 20-inches, Blue
AELL-U	Illuminated letter "U" 20-inches, Blue
AELL-V	Illuminated letter "V" 20-inches, Blue
AELL-W	Illuminated letter "W" 20-inches, Blue
AELL-X	Illuminated letter "X" 20-inches, Blue
AELL-Y	Illuminated letter "Y" 20-inches, Blue
AELL-Z	Illuminated letter "Z" 20-inches, Blue

Model	Description
Illuminated Characters, 15-inch Numbers	
AELN15-0	Illuminated Number "0" 15-inches, Blue
AELN15-1	Illuminated Number "1" 15-inches, Blue
AELN15-2	Illuminated Number "2" 15-inches, Blue
AELN15-3	Illuminated Number "3" 15-inches, Blue
AELN15-4	Illuminated Number "4" 15-inches, Blue
AELN15-5	Illuminated Number "5" 15-inches, Blue
AELN15-6	Illuminated Number "6" 15-inches, Blue
AELN15-7	Illuminated Number "7" 15-inches, Blue
AELN15-8	Illuminated Number "8" 15-inches, Blue
AELN15-9	Illuminated Number "9" 15-inches, Blue

Model	Description
Illuminated Characters, 20-inch Numbers	
AELN-0	Illuminated Number "0", 20-inches, Blue
AELN-1	Illuminated Number "1", 20-inches, Blue
AELN-2	Illuminated Number "2", 20-inches, Blue
AELN-3	Illuminated Number "3", 20-inches, Blue
AELN-4	Illuminated Number "4", 20-inches, Blue
AELN-5	Illuminated Number "5", 20-inches, Blue
AELN-6	Illuminated Number "6", 20-inches, Blue
AELN-7	Illuminated Number "7", 20-inches, Blue
AELN-8	Illuminated Number "8", 20-inches, Blue
AELN-9	Illuminated Number "9", 20-inches, Blue

Model	Description
Inverters	
AEL-PX300	Inverter for use with one or two numbers
AEL-PX450	Inverter for use with three numbers
Infrared/Thermal Power Supply	
AEL-PXIR-TH	Infrared/Thermal Power Supply for use with 1, 2 or 3 numbers
AirDeck	
AELAD-U15	AirDek, 2016-2018 Ford Utility low-profile
AELAD-U15	AirDek, 2013-2015 Ford Utility
AELAD-U16	AirDek, 2016-2018 Ford Utility
AELAD-TAH15	AirDek, 2013-2018 Chevy Tahoe

Model	Description
Mounting Pods	
AEL-PODB	Housing Pods, Black, order one per number
AEL-PODW	Housing Pods, white, order one per number



Effective April 1, 2018

Federal Signal Corporation LIMITED WARRANTY TERMS AND CONDITIONS Effective April 1, 2018

Federal Signal Corporation ("Federal Signal"), subject to the terms, conditions and exceptions contained herein, warrants each NEW product to be free from defects in material and workmanship, under normal and proper use, care, maintenance and required service only. Start of Warranty, Warranty periods and exceptions to the foregoing Limited Warranty are contained on the Schedule of Products included in this document, and are subject to change at the sole discretion of Federal Signal.

SPECIFIC EXCLUSIONS AND EXCEPTIONS

This Limited Warranty does NOT apply nor is it extended to products that are not manufactured by Federal Signal. These products may be covered by a separate limited warranty provided by the particular manufacturer and all claims and questions regarding the same are to be directed to the particular manufacturer. Goods sourced by Seller from a third party for resale to Buyer shall carry only the warranty extended by the original manufacturer.

Domes, lenses, lamps and batteries installed on Federal Signal products are specifically excluded. Repair or replacement of any product(s) or part(s) under this warranty does NOT extend the term of this warranty, and such product(s) or part(s) shall remain covered by the unexpired portion of the warranty period or for ninety (90) days from the date of return to Federal Signal, whichever is later. This limited warranty applies ONLY to the initial or first installation of the product. This limited warranty shall not apply to products (1) that have been subjected to neglect, abuse, misuse, improper installation, inadequate maintenance, or damage due to improper use of cleaning or cleaning materials or chemicals, or non-compliance with Federal Signal's storage, installation, operation, maintenance or environmental requirements; (2) that have undergone any modification or repair not previously authorized by Federal Signal in writing, or service, repair or modification by or from any facility other than an authorized Federal Signal service center or technician, or that use non-authorized software or spare or replacement parts; or (3) that fail due to reasonable and normal use or wear and tear, or materials made, furnished or specified by the Buyer or end user.

During the aforesaid warranty period, Federal Signal will, at its sole option, repair or replace the product(s) or particular part(s) that are found to be defective in either material or workmanship, or refund the purchase price for such product(s) or part(s), which are returned or delivered, transport or shipping prepaid by the Buyer or end user, to either Federal Signal or its designated and authorized warranty service center. This limited warranty does not cover travel expenses, the cost of specialized equipment for gaining access to the product(s) or part(s), or labor charges for removal and re-installation of the product.

No person or affiliated company representative is authorized to alter the terms of this warranty, to give any other warranties, to extend the term or duration of this warranty, or to assume any other liability on behalf of Federal Signal in connection with the sale, servicing or repair of any product manufactured by the Federal Signal.

Federal Signal reserves the right to make design changes and improvements in its products without imposing any obligation upon itself to change or improve previously manufactured products.

The use in the product of any part other than parts approved by Federal Signal may invalidate this warranty. Federal Signal reserves the right to determine, in its sole discretion, if the use of non-approved parts invalidates this warranty.

THIS WARRANTY IS IN LIEU OF ALL OTHER WARRANTIES, EXPRESS OR IMPLIED, INCLUDING, WITHOUT LIMITATION, WARRANTIES OF MERCHANTABILITY AND FITNESS FOR A PARTICULAR PURPOSE, AND REGARDLESS OF ANY FAILURE OF ESSENTIAL PURPOSE. ALL OTHER WARRANTIES OF WHATSOEVER KIND AND NATURE, WHETHER EXISTING IN CONTRACT OR AT LAW, ARE HEREBY AND FOREVER DISCLAIMED.

UNDER NO CIRCUMSTANCES WILL FEDERAL SIGNAL BE LIABLE OR RESPONSIBLE FOR SPECIAL, COMPENSATORY, INCIDENTAL, CONSEQUENTIAL OR PUNITIVE DAMAGES, LOST PROFITS, LOST SALES, OR LOSS OF USE OR LOSS OF BUSINESS OPPORTUNITY BY OR THROUGH THE USE OF THE PRODUCT. FEDERAL SIGNAL'S SOLE AND MAXIMUM LIABILITY WITH RESPECT TO THE PRODUCT, OTHER THAN ITS OBLIGATIONS SET FORTH ABOVE, SHALL BE THE TOTAL PURCHASE PRICE PAID FOR THE PRODUCT.

Federal Signal Corporation
LIMITED WARRANTY TERMS AND CONDITIONS
Effective April 1, 2018

	Warranty Period for Parts replacement from the date of manufacture stamped on the product	Warranty period for Factory Labor from the date of delivery to the first user-purchaser
Audible		
Speakers	2 years	1 year
Platinum 3000 Series	5 years	5 years
LED Products		
All LED (Light Emitting Diode) products unless otherwise noted	5 years	5 years
LED rotating light assemblies from all light bars and beacons	5 years	5 years
MicroPulse LED lights	3 years	3 years
416200 Series Corner LEDs	3 years	3 years
416400/416410 Corner LEDs	5 years	5 years
416500 Series Corner LEDs	3 years	3 years
416800/416810 Corner LEDs	3 years	3 years
MB1 LED Message Board	3 years	3 years
Commander Series Flex	2 years	2 years
COM550	3 years	3 years
4200S	3 years	3 years
Strobe products		
Strobe flash tubes	1 year	1 year
951 strobe beacons	5 years	1 year
651/851 strobe beacons	5 years	1 year
US5, US6 and US7 UltraStar	5 years	1 year
OTHER PRODUCTS		
Halogen Rotating Light assemblies from all light bars	5 years	1 year
All halogen rotating beacons and mini-light bars, except Sentinel	5 years	1 year
Littlite Map lights	5 year warranty on LED components Limited lifetime warranty on mechanical components	5 year warranty on LED components Limited lifetime warranty on mechanical components
SWM Interceptor Switch Modules	1 year	1 year
CAM Reverse Camera/Monitor Systems	3 years	3 years
Stinger Spike Systems	5 years	5 years
Air-EL	3 years	3 years
PBX Series	3 years	3 years
HRX Series	3 years	3 years
Perimeter Light Programmer	1 year	1 year
DOT Flasher	3 years	3 years
Atkinson Dynamics Intercoms	2 years	1 year
Note: Domes, lenses, lamps, and batteries are NOT covered under warranty.		



FEDERAL SIGNAL

We would love
to hear from you

www.fedsig.com

Customer Service

Phone: 1-800-264-3578 (1-708-534-3400) | policefireorders@fedsig.com

Technical Support

Repair: 1-800-433-9132 | Fire-EMSService@fedsig.com

Fire/Ambulance Marketing

Phone: 1-800-264-3578 | fireinfo@fedsig.com

Europe – Federal Signal Vama

C/DR. Ferran 7, 08339 Vilassar de Dalt, Barcelona Spain
Phone +34 937 41 79 00 | marketing@vama.es | www.fedsigvama.com

Latin & South America/Caribbean/Asia-Pacific/Middle East/Africa

Phone 1-708-534-3400 | policefireorders@fedsig.com