

Informer-IP Wall Mount

Model I-IPW Series C
Two-Way IP-enabled Intercom and Alarm Initiation Point



Strobe is optional.
(Version 3.2.0.1 and later)

Description, Specifications, Installation, and Operation Manual

Limited Warranty

This product is subject to and covered by a limited warranty, a copy of which can be found at www.fedsig.com/SSG-Warranty. A copy of this limited warranty can also be obtained by written request to Federal Signal Corporation, 2645 Federal Signal Drive, University Park, IL 60484, email to info@fedsig.com or call +1 708-534-3400.

This limited warranty is in lieu of all other warranties, express or implied, contractual or statutory, including, but not limited to the warranty of merchantability, warranty of fitness for a particular purpose and any warranty against failure of its essential purpose.



FEDERAL SIGNAL Safety and Security Systems

2645 Federal Signal Drive
University Park, Illinois 60484

www.fedsig.com

Customer Support 800-548-7229 • +1 708 534-3400

Technical Support 800-524-3021 • +1 708 534-3400

All product names or trademarks are properties of their respective owners.

Contents

Safety Messages	5
Safety Messages to Installers	5
General Description	8
Introduction	8
Features.....	8
Ordering Information	9
Specifications	10
Installation	11
Determine a Suitable Location	11
Wall Mounting	12
Recessed Mounting	13
Wiring the Device.....	14
Memory Card Removal and Installation.....	16
Testing and Training	16
Operations	16
Controls.....	17
Visual Indications	17
Audio/Relay - Input/Output Connections.....	18
Alert Rear Input.....	19
RS232 Port	19
Ethernet Port.....	19
Power Connector	19
Disable Microphone (Internal option).....	20
Replacement Parts	20
Getting Service	20

Tables

Table 1 Ordering Information	9
Table 2 Optional Accessories	9
Table 3 Specifications	10
Table 4 Compliance	11
Table 5 Controls.....	17
Table 6 Visual Indications (Located on keypad).....	17
Table 7 JP3 Input/Output Connections.....	19
Table 8 J1 Rear Input.....	19
Table 9 RS232 Connector Pin-out	19
Table 10 J2 Input Power (from transformer)	19
Table 11 JP3 (on the main PCB) Microphone Enable Jumper.....	20
Table 12 Replacement Part Numbers	20

Figures

Figure 1 Informer-IP Scrolling Message Display (optional).....	9
Figure 2 PS Series Push Button Stations (optional)	10
Figure 3 Rear View - Hole Measurements	12
Figure 4 Side View - Hole Measurements.....	13
Figure 5 Internal Wiring for the Informer-IP Wall Mount.....	15
Figure 6 Informer-IP Keypad	16
Figure 7 Input/Output Locations	18

Safety Messages

⚠ WARNING

It is important to follow all instructions shipped with this product. This device is to be installed by trained personnel who are thoroughly familiar with the country's electric codes and will follow these guidelines as well as local codes and ordinances, including any state or local noise-control ordinances. Listed below are important safety instructions and precautions you should follow:

Planning

- If suitable warning equipment is not selected, the installation site for the Informer is not selected properly or the Informer is not installed properly, it may not produce the intended optimum audible warning. If applicable, follow Federal Emergency Management Agency (FEMA) recommendations.
- If the Informer is not activated in a timely manner when an emergency condition exists, it cannot provide the intended audible warning. It is imperative that knowledgeable people, who are provided with the necessary information, be available at all times to authorize activation.
- The sound output of the Informer is capable of causing permanent hearing damage. To prevent excessive exposure, carefully plan placement, post warnings, and restrict access to areas near sirens.
- Activating the Informer may not result in people taking the desired actions if those to be warned are not properly trained about the meaning of warning sounds. Users should follow FEMA recommendations and instruct those to be warned of correct actions to be taken.

After installation, service, or maintenance, test the system to confirm that it is operating properly. Test the system regularly to confirm that it will be operational in an emergency.

Safety Messages to Installers

People's lives depend on your safe installation of our products. It is important to follow all instructions shipped with this product. This device is to be installed by a trained electrician who is thoroughly familiar with the National Electrical Code and/or Canadian Electrical Code and will follow the NEC and/or CEC Guidelines as well as all local codes.

The selection of the mounting location for this Informer, its controls, and the routing of the wiring is to be accomplished under the Facilities Engineer and the Safety Engineer's direction. Listed below are some other important safety instructions and precautions you should follow:

- Electrocutation or severe personal injury can occur when performing various installation and service functions such as making electrical connections, drilling holes, or lifting equipment. Therefore, only experienced electricians should install this product per national, state, and any other electrical codes having jurisdiction. Perform all work under the direction of the installation or service crew safety foreman.
- Read and understand all instructions before installing, operating, or servicing this equipment.

Safety Messages

- All effective warning sounds may, in certain circumstances, cause permanent hearing loss. Take appropriate precautions, such as wearing hearing protection. The maximum sound level exposure limits specified in OSHA 29 CFR 1910 should not be exceeded. Review and comply with any local or state noise control ordinances as well as OSHA noise exposure regulations and guidelines.
- For optimum sound distribution, do not install this speaker where objects would block any portion of the front of the Informer.
- Establish a procedure to check the signal system for proper activation and operation routinely.
- Any maintenance to the unit **MUST** be performed by a trained electrician per NEC Guidelines and local codes or a Federal Signal certified Service Provider.
- Never alter the unit in any manner.
- The nameplate should **NOT** be obscured, as it contains cautionary and/or other information of importance to maintenance personnel.
- After installation and completion of the initial system test, provide a copy of these instructions to all personnel responsible for the operation, periodic testing, and equipment maintenance.
- File these instructions safely and refer to them when maintaining and/or reinstalling the device.

Failure to follow all safety precautions and instructions may result in property damage, serious injury, or death.

Installation and Service

- After installation or service, test the system to confirm that it is operating properly. Test the system regularly to confirm that it will be operational in an emergency.
- If future service and operating personnel do not have these instructions to refer to, the system may not provide the intended audible warning, and service personnel may be exposed to death, permanent hearing loss, or other bodily injuries. File these instructions in a safe place and refer to them periodically. Give a copy of these instructions to recruits and trainees. Also, give a copy to anyone who is going to service or repair the Informer.
- To reduce the risk of electric shock, do not perform any servicing other than what is contained in the operating instructions unless you are qualified to do so. Refer all servicing to qualified service personnel. Always test the Informer before using after repairs have been made.

Ethernet Wiring

- Unless shielded or run in conduit, Ethernet wiring must be at least six feet from bare power wiring or lightning rods and associated wires, and at least six inches from other wire (for example, antenna wires, doorbell wires, wires from transformers to neon signs), steam or hot water pipes, and heating ducts.
- Do not place Ethernet wiring or connections in any conduit, outlet or junction box containing high voltage electrical wiring.

Symbol Definition

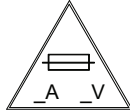

Indicates to reduce the risk of fire, replace the fuse as marked.

Pay careful attention to the notice located on the equipment.

Read and understand the information contained in this manual before attempting to install or service the Informer.

General Description

Introduction

The Informer-IP Wall Mount is an intercom, a warning device, and an alarm initiation point that connects to an Ethernet network. An internal speaker is used to provide clear, two-way voice communications between control and monitoring points and distributed locations. You can trigger two different alerts using the contact closure input and the ALERT button.

The Informer-IP has an audio output for connecting to existing PA systems and two relay outputs to control strobes or other devices. An RS232 port is available for driving an optional scrolling message display. The Informer-IP provides seven standard alert tones and can store up to 4,000 voice or tone messages with 17 hours of total prerecorded tone and voice alerts.

You can wall mount or recess the unit. You can power it through Power over Ethernet (PoE) from a network or through local AC power. (Use of strobe requires AC powering or external powering of a strobe.) Using existing network infrastructure significantly lowers installation costs and simplifies wide-scale deployments.

The Informer-IP provides an unmatched value for two-way indoor alert and notification for schools, hospitals, police and fire stations, government facilities, and industrial plants.

See the Informer-IP Series C Setup, Program, and User Manual (part number 25500395 revision C or later) to learn how to set up, configure, program, and use Informer-IP devices.

Features

The Informer-IP has the following features; some features require using the Federal Signal Commander® software system:

- Tone and Voice Alert and Notification compatible with Federal Signal Controllers.
- Two-Way Intercom with Remote audio monitoring, recording, and playback.
- Removable microSD card for custom message generation. Store up to 4000 voice or tone messages that total up to 17 hours of recording time.
- Integrated Modbus® TCP industrial PLC interface for control and monitoring.
- Integrated SIP phone interface for live PA, remote wave file, and function control.
- Commander and CommanderOne® HMI software provide configuration, control, activation, and notification options.
- Small size, rugged construction, and wide operating temperature range.
- High-output speaker with adjustable volume control and exceptional sound quality.
- Seven factory-installed siren tones: wail, alternate wail, pulsed wail, steady, alternate steady, pulsed steady, and Westminster chime (auxiliary).
- LED status indicators for Power, Alert, Test, and Talk.
- Ability to activate onboard relays for strobe or other external devices.

- REPLAY button allows Alert messages to be replayed when the red Alert LED is flashing.
- RESET button Silences Alerts.
- Local and remote volume level controls.
- Informers are addressable Individually, in Groups, or All.
- Requires minimal network bandwidth and uses TCP/IP protocol for security and reliability.
- Remote supervision of Communications, Audio Output, Alert Function Execution.
- Supports fixed IP, DHCP, and Auto-IP.
- Wired Ethernet.
- Works with redundant SmartMsg and Commander® network servers for reliable fail-safe operation with full two-way control, status monitoring, and configuration of the Informer-IP.

Ordering Information

Table 1 Ordering Information

Part Numbers	Description
I-IPW	Informer-IP Wall Mount

Informer-IP requires Federal Signal Commander application software.

There is a programming fee associated with Informer-IPs programmed at the factory. Contact your local representative for a quotation.

Table 2 Optional Accessories

Part Numbers	Description
I-SMD2-36	Scrolling Message Display (2 x 36 inches)
I-IP-SW	Informer-IP Setup Wizard Software and Cable
PSEV-YM	Yellow Station with Momentary Contact – “EVACUATION”
PSEVSC-YM	Yellow Station with Momentary Contact and Sounder Cover – “EVACUATION”
PSEM-RM	Red Station with Momentary Contact – “EMERGENCY”
PSEMSC-RM	Red Station with Momentary Contact and Sounder Cover – “EMERGENCY”
LP1-012*	12 VDC Strobe (can be powered by the internal power supply for I-IPW)

*(A) Amber, (B) Blue, (C) Clear, (G) Green or (R) Red (I-IPW only)

The following figure illustrates the scrolling message display.

Figure 1 Informer-IP Scrolling Message Display (optional)



Specifications

The following figure illustrates the wall-mounted buttons for activation.

Figure 2 PS Series Push Button Stations (optional)



Specifications

Table 3 Specifications

Operating Voltages at J2 using AC Transformer	9-15 Vdc 108-128 Vac, 60 Hz with wall transformer
Operating Current	Standby: 9 V = < 200 mA, 12 V = < 150 mA With siren or message audio: 9 V = < 450 mA, 12 V = < 350 mA
Operating with PoE, IEEE 802.3af, 48V input	PoE: 42 to 57 VDC, IEEE 802.3af units shipped prior to February 2014: mode B units shipped after February 2014: mode A Standby: < 60 mA With siren or message audio: <110 mA
Audio Data Playback Storage	17 hours and 4,000 messages with 2 GB microSD card
Audio Frequency response	300-3000 Hz, +1 to -3 dB per octave
Audio Output	0.5 W into 8 ohms
Audio Distortion	< 5% at 80 dB output, with 700 Hz tone
Warning Siren Audio	Seven user-configurable tones
Internal Failure Alarm	Unit will sound a short, low-level beep once every 30 seconds if network connectivity is lost.
Serial Port	RS232C, N, 8, 1 Baud rate configurable
Ethernet Port	IEEE 802.3, 10 BASE-T connection
Operating temp range	-22°F to +140°F (-30°C to + 60°C)
Humidity range	0-95%, non-condensing
Size (H x W x L)	8.3 x 7.0 x 3.3 inches (210.82 x 177.8 x 83.82 mm)
Weight	3.2 lb (1.5 kg)

Table 4 Compliance

Electromagnetic Interference	Complies with FCC Title 47, Part 15
FCC Part 15 Class B	Radio Frequency Interference (RFI) (FCC 15.105) The Informer-IP Wall Mount was tested and found to comply with the limits for Class B digital devices pursuant to Part 15 Subpart B of the FCC Rules. These limits are designed to provide reasonable protection against harmful interference in a residential environment. This equipment generates, uses, and can radiate radio frequency energy, and if not installed and used in accordance with the instruction manual, may cause harmful interference to radio communications. However, there is no guarantee that interference will not occur in a particular installation. If this equipment does cause harmful interference to radio or television reception, which can be determined by turning the equipment off and on. Try to correct the interference by one or more of the following measures: <ul style="list-style-type: none"> • Increase the separation between the equipment and the receiver. • Connect the equipment to a different circuit than the receiver that it is connected to.
Agency Compliance	Complies with UL 60065 and C22.2 No. 60065

Installation

⚠ WARNING

Read and adhere to all safety warnings in this manual before installing the Informer-IP.

To prevent injury, this apparatus must be securely attached to the wall per the installation instructions.

⚠ DANGER

ELECTROCUTION HAZARD: Electrocution or severe personal injury can occur when making electrical connections, drilling holes, or lifting equipment. Therefore, experienced electricians, per national and local electrical codes, acting under the installation crew safety foreman's direction, should perform the installation.

Determine a Suitable Location

When choosing a location for the Informer-IP, consider the following criteria:

- Place as far as possible from electrically noisy electronic devices to avoid interference. Examples of noisy devices may include microwave ovens, motor-driven devices, light ballasts, and electrical switching devices.
- Requires a connection to a wired Ethernet network. Ethernet wire runs must be less than 328 feet (100 meters) from the nearest network switch.
- Place in an area where you can hear the speaker when the Informer-IP is activated. You can check the warning tone level by holding the VOLUME up and down buttons until the desired level is reached. If the coverage area is large, multiple Informer-IP or external amplifiers and speakers may be required to provide adequate warning.

- Position to keep the unit at least 6 inches (15.24 cm) away from the listener's ears to avoid potential hearing damage.
- Do not use near water, for example, near a bathtub, washbowl, kitchen sink, laundry tub, in a wet basement, near a swimming pool, rain, or similar environments.
- Place where it will not be inadvertently covered or moved. A permanent wall mounting is recommended after you have found a suitable location.

Wall Mounting

Wall mounting is the preferred mounting method for the Informer-IP. Before mounting, determine a suitable location considering the criteria listed. The Informer-IP has eight holes, two sets of four, located on the back of the unit that accepts #8 screws. Mounting location determines which set of four holes is used. Exterior wiring can enter the Informer-IP through any of the unit's five knockouts: two on the back, one on the bottom, and one located on each side of the unit. Place the mounting screws horizontally level, approximately 6 inches (15.2 cm) above eye level and 4 inches (10.16 cm) apart on center. Ensure the screws are placed into material that can adequately support the weight of the Informer-IP. Use #8 wall anchors when mounting to the drywall. Ensure that the screws are tightened sufficiently to fasten the Informer-IP against the wall securely.

Figure 3 Rear View - Hole Measurements

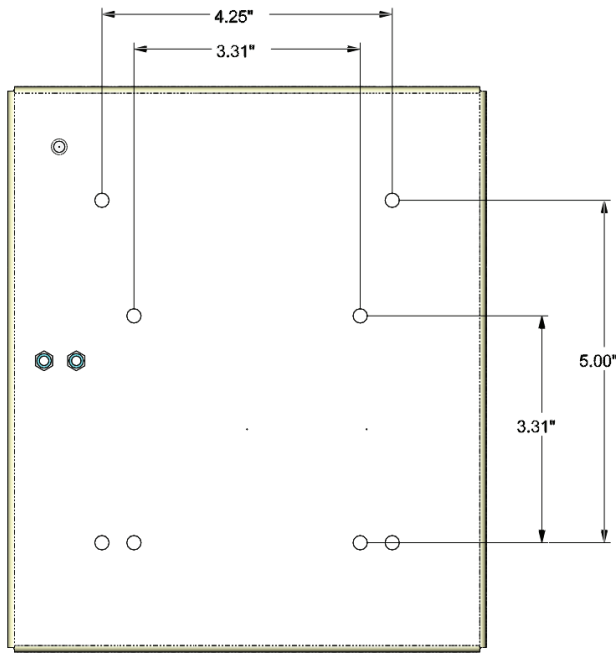

Connect the Informer-IP to the LAN using CAT5 cable. If the wired Ethernet has PoE, no other power connection is required. [Early versions of the Informer-IP require a PoE Adapter (2005704A) and additional cable (1751407A) to supply correct PoE wiring.]

Recessed Mounting

Before putting the Informer-IP in place, determine a suitable location considering the criteria listed in this manual. The Informer-IP has four holes for recessed mounting, two sets of two, located on the unit's sides, which accept #10 screws. Mounting location determines which set of holes is used or both. Exterior wiring can enter the Informer-IP through any of the unit's knockouts: located on the back, bottom, and each side of the unit. Place the mounting screws horizontally level. Ensure the screws are placed into material that can adequately support the weight of the Informer-IP.

Figure 4 Side View - Hole Measurements



To recess mount:

1. Cut a hole that is 8.25 by 7.25 by 3 inches (H x W x D), which is slightly larger than the Informer-IP base and next to a wall stud.
2. Attach the face bracket to the sides of the unit using the four 10-32 screws included.
3. Slide the Informer-IP into the wall and from the inside of the unit, mark the side hole locations on the wall stud.
4. Remove the unit and drill the two holes for #10 screws.
5. Place the mounting screws horizontally level.

NOTE: Ensure the screws are placed into material that can adequately support the weight of the Informer-IP and that the screws are tightened sufficiently to fasten the unit to the stud securely.

Wiring the Device

⚠ WARNING

SHOCK HAZARD: *To reduce the risk of electric shock, disconnect AC power before connecting or removing AC power wires. Failure to heed this warning may cause serious injury or death.*

1. Install this device by a qualified electrician per local and national electrical codes (NEC/CEC).
2. Make the supply connections directly to the terminal three-position terminal block located internally on the back the housing's wall. The Informer-IP has a universal input that can be connected to a 115 V line and neutral, or to two 115 V lines.
3. Route the supply wires (10 AWG to 16 AWG) into the housing.
4. Strip a maximum of 0.28 inch (7 mm) of insulation from the ends of the power leads. Coil any excess wire and secure under the terminal block to avoid contact with other wiring and components.
5. Connect the wires to the terminal block by inserting the stripped ends of the wires into the connectors as far as they can travel.
 - Connect the earth ground to the terminal block position G.
 - Connect the line (hot, L1) wire to position L.
 - Connect the neutral or the L2 wire to position N.
6. Tighten the clamping screw. The maximum tightening torque is 7.0 in-lb (0.8 N • m).
7. Connect the earth ground to the terminal block.
8. Route the Ethernet cable into the housing using the supplied rubber grommet.
9. Optional: If installing an LP1 strobe:
 - Find the loose wires for the LP1 strobe.
 - Attach the stripped black wire to the LP1 strobe negative (-) terminal.
 - Tighten the clamping screw. The maximum tightening torque is 7.0 in-lb (0.8 N • m).
 - Attach the red wire to the positive (+) terminal.
 - Run the wires through the rubber gasket and the top of the Informer-IP Wall Mount.
 - Attach the LP1 strobe to the top of the Informer-IP Wall Mount using the LP1 supplied hardware.
 - Attach the red and black wires to the connectors inside the Informer-IP Wall Mount.

Figure 5 Internal Wiring for the Informer-IP Wall Mount

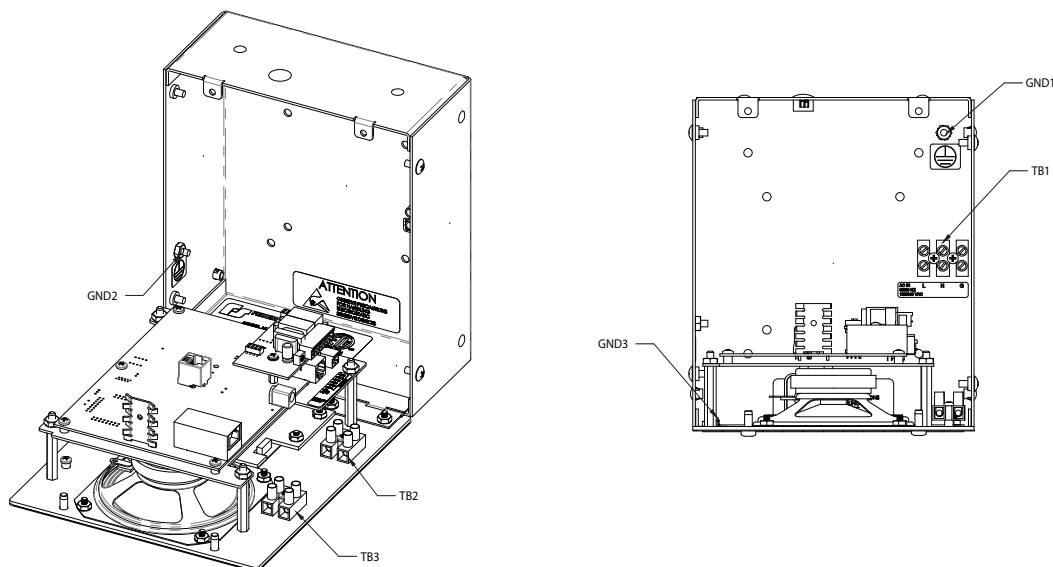
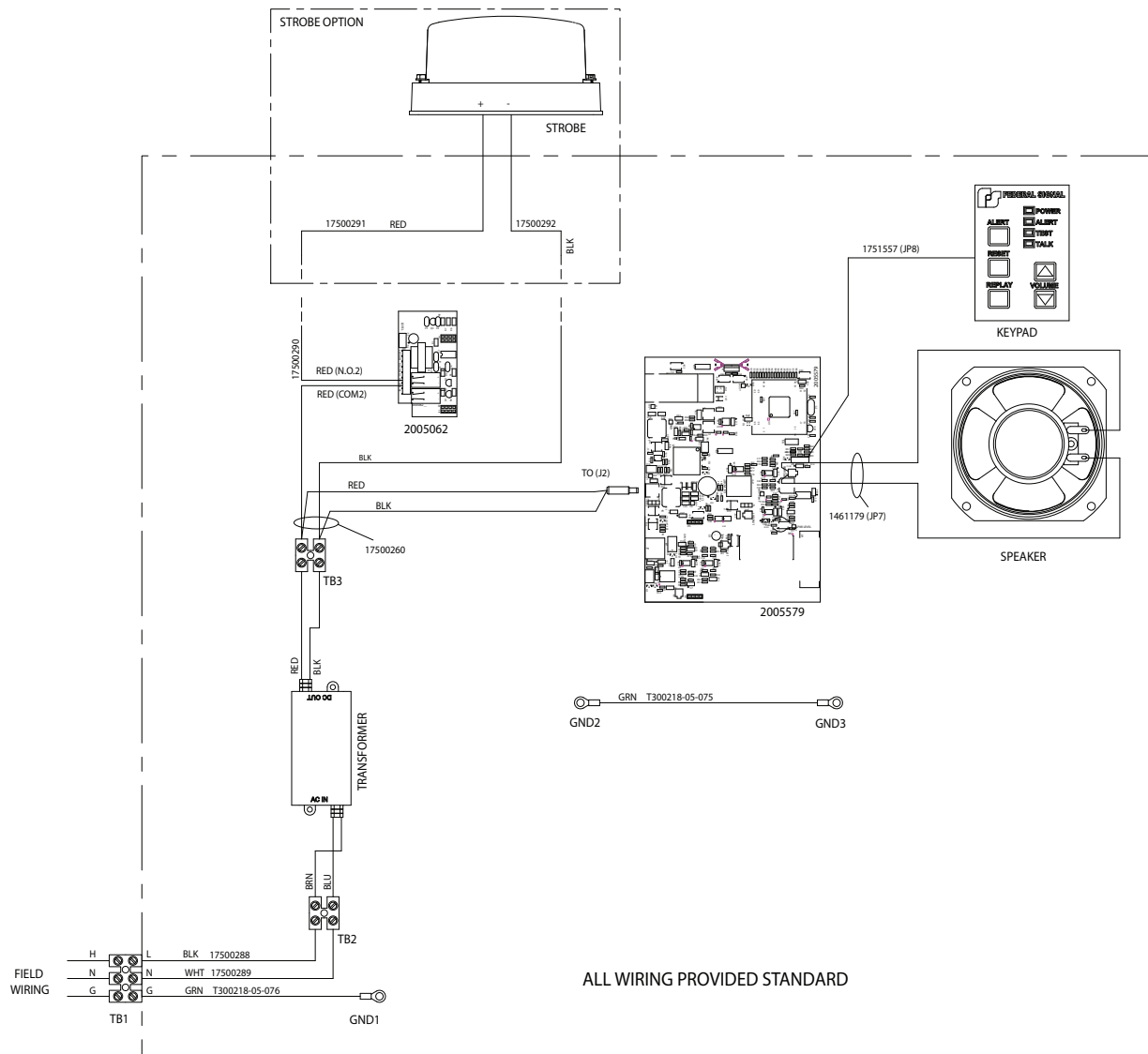

The Informer-IP Wall Mount is internally wired.

Memory Card Removal and Installation

The microSD card stores voice and tone messages.

To remove the card:

1. Open front panel cover.
2. Find the microSD card.
3. Gently push the card into the slot. The card can then be removed.

To install the card:

1. Insert and gently push the card until it latches into place.
2. Replace cover and tighten screws.

Testing and Training

After the installation is complete:

- Test the Informer-IP and all accessories from the control point(s) to ensure it is operating properly.
- Ensure all users are properly trained to use the system before putting the Informer-IP into service.
- Verify all tone, voice, and text messages contain the correct content per the emergency operating plan. Alerts should exceed the ambient sound levels by at least 10 dB to ensure they can be heard.
- Conduct testing regularly per facility safety plans to ensure the equipment remains in working order, and operators remain familiar with the use of the equipment.

Operations

The following is a picture of the Informer-IP keypad.

Figure 6 Informer-IP Keypad

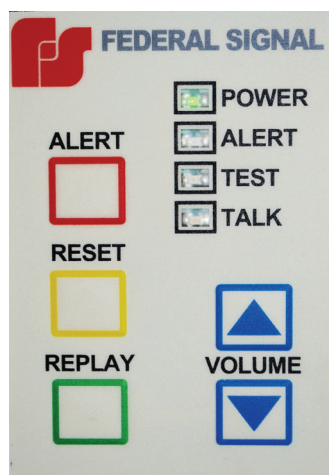

Controls

Table 5 Controls

Button	Description
Volume Up Button	Increases volume and beeps at the current volume level.
Volume Down Button	Decreases volume and beeps at the current volume level.
ALERT	<p>The ALERT button sends an activation to the control points and changes the status icon to Red. You can also configure each input as a Call Request to alert emergency operations personnel that an intercom chat session is being requested. You can configure each of the six alert inputs with application-specific names.</p> <p>A Call Request is a request for an Intercom Chat Session with the Emergency Operations personnel at the control point(s). The Call Request opens the Commander Intercom window and turns on the red Call Request status icon next to the Unit ID and Unit Name of the Informer-IP that issued the request.</p>
RESET	<p>Push to reset the following:</p> <ul style="list-style-type: none"> • Alert Signals • Alert, Test, and Talk LEDs • Scrolling Message Display • Relay Outputs
REPLAY	The REPLAY button replays the last voice message received if the red alert light is blinking. If the Alert light is not blinking, the event has ended or reset, which removes the message from memory.

Visual Indications

Table 6 Visual Indications (Located on keypad)

LED	Description
POWER	The green Power LED turns on when power is connected, and the device is connected to a Federal Signal enabled network server. The Power LED flashes on for 100 ms when the unit is disconnected from the server.
ALERT	The red Alert LED Flashes on and off at a 1/2 second interval when an alert is received. The LED is reset when the RESET button is pressed, or a reset command is sent from a control station.
TEST	The yellow Test LED turns on Steady when a Quiet Test function is executed. The LED is reset when the RESET button is pressed, or a reset command is received from a control station. The LED flashes on and off at a 1/10 second rate indicating the unit has been reset to factory defaults and requires configuration. The unit does not attempt to connect to a server when this LED is flashing.
TALK	The blue Talk LED flashes at a 1/10 second interval when a Live PA, Intercom Talk session, or Text-To-Speech message is in progress. The Talk LED turns on steady when the intercom monitor function is active. During an Intercom chat session, the local operator must listen while the blue LED is blinking and may talk when the LED is on steady. Audible turn-around beeps also indicate the transitions from Talk and Listen modes. The Intercom chat session ends when the control point Ends the Call or Resets the device.

The following indicators are for troubleshooting purposes only. These indicators are not visible when the unit is closed.

Figure 7 Input/Output Locations

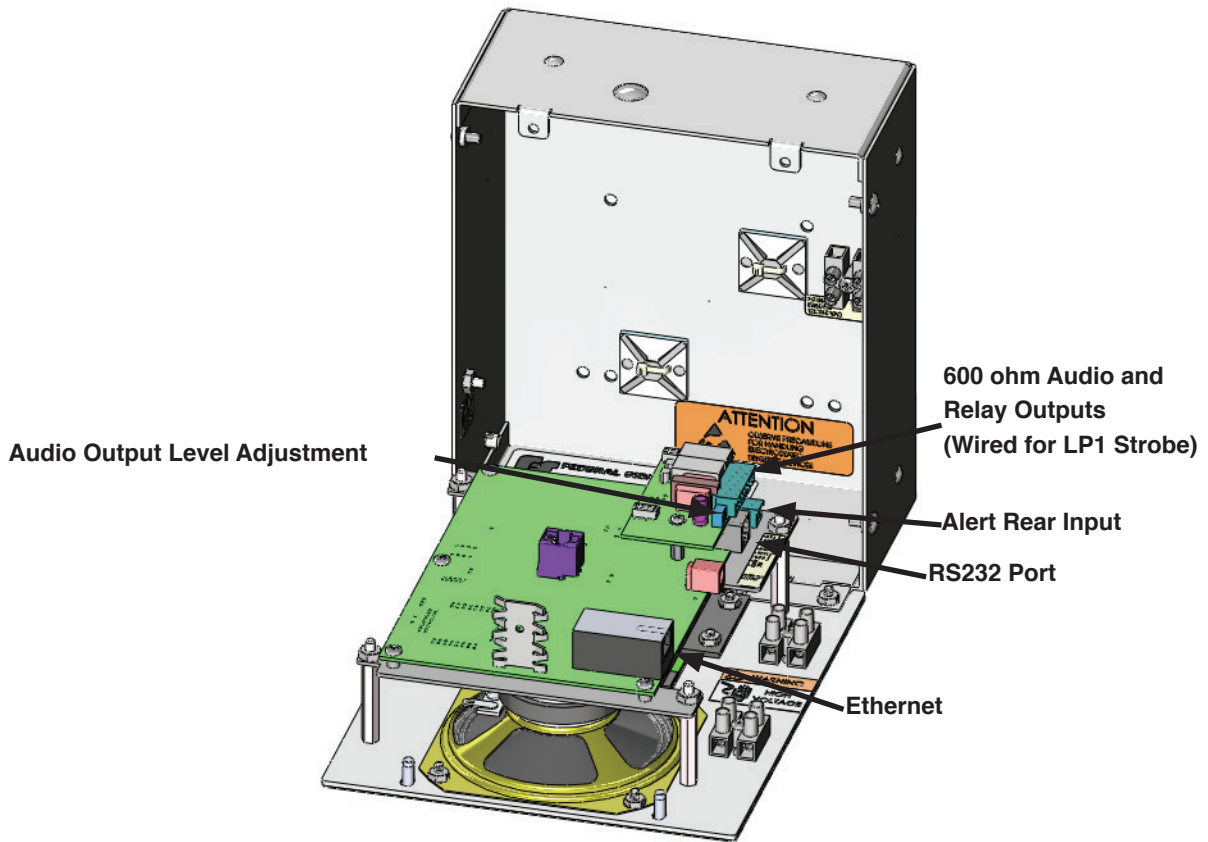

Audio/Relay - Input/Output Connections

The Informer-IP has two SPDT relays rated at 5 A at 30 Vdc. The relays can be programmed to cycle on and off, or come on continuously with programmable on time, off time, and total-time. The relay outputs can be reset manually or reset after a programmable number of seconds. Relay 2 is pre-wired for use with an LP1 12 Vdc strobe.

A removable eight-position connector is located on the inside of the Informer-IP for making electrical connections. The connector accepts 3/16-inch (5 mm) stripped wire, 18-26 AWG.

The 600-ohm audio output responds as the speaker does. Audio comes on with the speaker and is reset or shut off when the speaker audio shuts off. The output level is adjustable from 0 to 2.5 V_{p-p} into 600 ohms with a 1 kHz tone. The audio out is not active during Intercom sessions. Make electrical connections to the Input/Output connector as follows.

Table 7 JP3 Input/Output Connections

JP3	(Field Wiring) 1 – Normally closed, relay #2 (Right hand side of connector) 2 – Common, relay #2 (Pre-wired to 12 Vdc) 3 – Normally open, relay 2 (Pre-wired to Strobe) 4 – Normally closed, relay #1 5 – Common, relay #1 6 – Normally open, relay 1 7 – 600 ohms audio output 8 – 600 ohms audio output
-----	---

Alert Rear Input

Located on the inside of the Informer-IP Wall Mount housing is a two-position Rear Input Connector. The removable connector accepts 3/16-inch (5 mm) stripped wire, 18-26 AWG.

Table 8 J1 Rear Input

J1	Rear Input (Dry contact across pins activates input) 2 – Active low input (Pulled to 4.5 Vdc internally through 4.75 kilohms) 1 – Ground
----	--

RS232 Port

The RS232 Port uses a six-pin modular connector. Federal Signal can provide pre-terminated cables when scrolling message displays are purchased.

Table 9 RS232 Connector Pin-out

Pin	Description
1	Serial / Flash Select
2	TXD
3	RXD
4	GND
5	CTS / Serial Clock In
6	RTS

Ethernet Port

The Informer-IP has an eight-pin Ethernet port for connecting to the Communications network. The port accepts 42 to 57 Vdc PoE per IEEE 802.3af. Ethernet wire runs must be less than 328 feet (100 meters) from the nearest network switch. The wired Ethernet port auto-negotiates at 10/100 Mbps, full or half-duplex connection.

Power Connector

The Informer-IP has an integral 120/240 Vac transformer. The transformer provides power to J2.

Table 10 J2 Input Power (from transformer)

J2	Power connector Center – (9 to 15 Vdc) Outside – GND
----	--

Disable Microphone (Internal option)

Internal on the PCB is JP3, which normally has a shorting plug to enable the built-in microphone functionality. Model I-IPW Series B and Series C of the Informer series uses the speaker as the microphone.

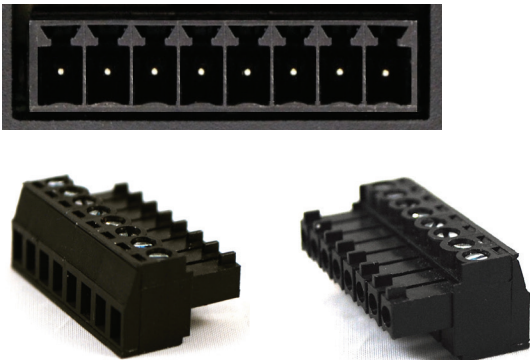

Table 11 JP3 (on the main PCB) Microphone Enable Jumper

JP3	Short to enable microphone functionality, remove to disable.
-----	--

Replacement Parts

The Informer-IP uses one of these two types of connectors: one with slots or one without slots. Match the eight-pin connector of your Informer-IP to the picture below and order the corresponding part number.

Table 12 Replacement Part Numbers

Picture	Part Number
	13900406A-08
	140372A-08

Getting Service

If you are experiencing any difficulties, contact Federal Signal Customer Support at 800-548-7229 or 708-534-3400 extension 7511 or Technical Support at 800-524-3021 or 708-534-3400 extension 7329 or through e-mail at techsupport@fedsig.com. For instruction manuals and information on related products, visit <http://www.fedsig.com/>