



FEDERAL SIGNAL
Safety and Security System

Four-, Six- and Nine-Button Convergence Controllers



Installation and Maintenance Instructions

25500568

Rev. A1 0820

Printed in U.S.A

© Copyright 2019-2020 Federal Signal Corporation

Limited Warranty

This product is subject to and covered by a limited warranty, a copy of which can be found at www.fedsig.com/SSG-Warranty. A copy of this limited warranty can also be obtained by written request to Federal Signal Corporation, 2645 Federal Signal Drive, University Park, IL 60484, email to info@fedsig.com or call +1 708-534-3400.

This limited warranty is in lieu of all other warranties, express or implied, contractual or statutory, including, but not limited to the warranty of merchantability, warranty of fitness for a particular purpose and any warranty against failure of its essential purpose.



FEDERAL SIGNAL Safety and Security Systems

2645 Federal Signal Drive
University Park, Illinois 60484

www.fedsig.com

Customer Support

Police/Fire-EMS: 800-264-3578 • +1 708 534-3400

Work Truck: 800-824-0254 • +1 708 534-3400

Technical Support 800-433-9132 • +1 708 534-3400

Contents

Safety Message to Installers and Service Personnel.....	4
Safety Messages to Operators of Sound/Light Systems	8
Overview.....	11
Mounting the Convergence Controllers.....	15
Wiring the Convergence Controllers	19
Operating the Convergence Controller	21
Four-Button Convergence Controller.....	23
Six-Button Convergence Controller	26
Six-Button Keypad Selection	26
Nine-Button Convergence Controller	37
Testing the System.....	42
Convergence Controller Legends and Safety Messages	43
Getting Technical Support.....	44
Getting Repair Service	44

Figures

Figure 1 - Swivel Mount	16
Figure 2 - Secure to Mounting Surface.....	17
Figure 3 - Four-Button Keypad.....	23
Figure 4 - Six-Button Keypad	26
Figure 5 - Nine-Button Keypad.....	37
Figure 6 - Replacing Legends	43

Tables

Table 1 - System Specifications	12
Table 2 - Four-Button Kit Contents	13
Table 3 - Six-Button Kit Contents.....	13
Table 4 - Nine-Button Kit Contents	14
Table 5 - Ignition Power Wiring	19
Table 6 - Modes and Flash Patterns.....	21

Safety Message to Installers and Service Personnel

Safety Message to Installers and Service Personnel

⚠ WARNING

People's lives depend on your proper installation and servicing of Federal Signal products. It is important to read and follow all instructions shipped with this product. Listed below are some other important safety instructions and precautions you should follow:

Before Installation

Qualifications

- To properly install an electronic siren, you must have a good understanding of automotive electrical procedures and systems, along with proficiency in the installation and service of safety warning equipment. Always refer to the vehicle's service manuals when performing equipment installations on a vehicle.

Sound Hazards

- Your hearing and the hearing of others, in or close to your emergency vehicle, could be damaged by loud sounds. This can occur from short exposures to very loud sounds, or from longer exposures to moderately loud sounds. For hearing conservation guidance, refer to federal, state, or local recommendations. OSHA Standard 1910.95 offers guidance on "Permissible Noise Exposure."
- All effective sirens and horns produce loud sounds (120 dB) that may cause permanent hearing loss. Always minimize your exposure to siren sounds and wear hearing protection. Do not sound the siren indoors or in enclosed areas where you and others will be exposed to the sound.
- Federal Signal siren amplifier/relay modules and speakers are designed to work together as a system. Combining a siren and speaker from different manufacturers may reduce the warning effectiveness of the siren system and may damage the components. Verify or test your combination to make sure the system works together properly and meets federal, state, and local standards or guidelines.

Safety Message to Installers and Service Personnel

During Installation

- Do NOT get metal shavings inside the product. Metal shavings in the product can cause the system to fail. If drilling must be done near the unit, place an ESD approved cover over the unit to prevent metal shavings from entering the unit. Inspect the unit after mounting to ensure that there are no shavings present in or near the unit.
- Do NOT connect this system to the vehicle battery until ALL other electrical connections are made, mounting of all components is complete, and you have verified that no shorts exist. If wiring is shorted to vehicle frame, high current conductors can cause hazardous sparks, resulting in electrical fires or flying molten metal.
- Ensure that the siren amplifier/relay module and speaker(s) in your installation have compatible wattage ratings.
- In order for the electronic siren to function properly, the ground connection must be made to the NEGATIVE battery terminal.
- Sound output will be severely reduced if any objects are in front of the speaker. If maximum sound output is required for your application, ensure that the front of the speaker is clear of any obstructions.
- Install the speaker(s) as far forward on the vehicle as possible, in a location that provides maximum signaling effectiveness and minimizes the sound reaching the vehicle's occupants. Refer to the National Institute of Justice guide 500-00 for further information.
- Mounting the speakers behind the grille will reduce the sound output and warning effectiveness of the siren system. Before mounting speakers behind the grille, make sure the vehicle operators are trained and understand that this type of installation is less effective for warning others.
- Sound propagation and warning effectiveness will be severely reduced if the speaker is not facing forward.

Safety Message to Installers and Service Personnel

Carefully follow the installation instructions and always install the speaker with the projector facing forward.

- Do NOT install the speaker(s) or route the speaker wires where they may interfere with the operation of airbag sensors.
- Installation of two speakers requires wiring speakers in phase.
- Never attempt to install aftermarket equipment, which connects to the vehicle wiring, without reviewing a vehicle wiring diagram available from the vehicle manufacturer. Ensure that your installation will not affect vehicle operation and safety functions or circuits. Always check vehicle for proper operation after installation.
- Do NOT install equipment or route wiring or cord in the deployment path of an airbag.
- If a vehicle seat is temporarily removed, verify with the vehicle manufacturer if the seat needs to be recalibrated for proper airbag deployment.
- Locate the Convergence Controller so the vehicle, controls, and microphone can be operated safely.
- When drilling into a vehicle structure, be sure that both sides of the surface are clear of anything that could be damaged. All drilled holes should be deburred and all sharp edges should be smoothed. All wires going through drilled holes should be protected by a grommet or convolute/split-loom tubing. Additionally, all exterior drilled holes must be sealed with Motorcraft seam sealer T-A-2-B or equivalent to prevent the potential exposure to carbon monoxide or other potentially harmful fumes. Failure to observe this warning could cause serious injury or death.

After Installation

- After installation, test the siren and light system to ensure that it is operating properly.

Safety Message to Installers and Service Personnel

- Test all vehicle functions, including horn operation, vehicle safety functions and vehicle light systems, to ensure proper operation. Ensure that installation has not affected vehicle operation or changed any vehicle safety function or circuit.
- After testing is complete, provide a copy of these instructions to the instructional staff and all operating personnel.
- File these instructions in a safe place and refer to them when maintaining or reinstalling the product.

Failure to follow all safety precautions and instructions may result in property damage, serious injury, or death.

RETAIN AND REFER TO THESE MESSAGES

Safety Messages to Operators of Sound/Light Systems

⚠ WARNING

People's lives depend on your safe operation of Federal Signal products. It is important to read and follow all instructions shipped with the products. Listed below are some other important safety instructions and precautions you should follow:

- Do not attempt to activate or deactivate the light system control while driving in a hazardous situation.
- Although your warning system is operating properly, it may not be completely effective. People may not see or heed your warning signal. You must recognize this fact and continue to drive cautiously.
- Situations may occur that obstruct your warning signal when natural and man-made objects are between your vehicle and others, such as raising your hood or trunk lid. If these situations occur, be especially careful.
- All effective sirens and horns produce loud sounds that may cause, in certain situations, permanent hearing loss. You and your passengers should consider taking appropriate safety precautions, such as wearing hearing protection.
- In order to be an effective warning device, this product produces bright light that can be hazardous to your eyesight when viewed at close range. Do not stare directly into this lighting product at close range, or permanent damage to your eyesight may occur.
- It is important that you fully understand how to safely operate this warning system before use.
- Operate your vehicle and its light/sound system in accordance with your department's Standard Operating Procedures.
- If a selected function does not perform properly or if any of the lamps remain illuminated when the control is off,

Safety Messages to Operators of Sound/Light Systems

disconnect the power connector from the control unit and contact the nearest service center.

- At the start of your shift, ensure that the entire warning light system and the siren system are securely attached and operating properly.
- The effectiveness of an interior mounted warning light depends on the clarity, tinting, and angle of the glass it is behind. Tinting, dirt, defects, and steeply angled glass reduce the light output of the warning light. This may reduce the effectiveness of the light as a warning signal. If your vehicle has dirty, tinted, or steeply angled glass, use extra caution when driving your vehicle or blocking the right of way with your vehicle.
- Suction cup mounting is for temporary applications only. Remove the unit from the window and store it securely when not in use. Temperature changes and sunlight can cause suction cups to lose holding power. Periodically check the unit to make sure the suction cups have a firm grip on the mounting surface. An improperly secured light could fall off of the vehicle, causing injury and damage.
- The holding power of magnetic mounting systems is dependent upon surface finish, surface flatness, and thickness of the steel mounting surface.

Therefore, to promote proper magnetic mounting:

- The mounting surface and magnets must be kept clean, dry, and free of foreign particles that prevent good surface contact.
- Ensure that the mounting surface is flat.
- Do not use a magnet mounting system on vehicles with vinyl tops.
- To prevent the light assembly from sliding on the mounting surface, avoid quick acceleration and hard stops.

Failure to follow these precautions may result in property damage, serious injury, or death.

RETAIN AND REFER TO THESE MESSAGES

Overview

The Convergence Controllers are full-featured, programmable, electronic siren and light controllers. State-of-the-art microprocessor technology is used to create a compact controller that can be installed in various interior locations of any vehicle with a 12 V or 24 V negative ground system. The Convergence Controller has an easily accessible Convergence™ Network serial port that can connect to any serially-controlled Federal Signal product. If it is to be used with a Pathfinder, refer to “Pathfinder Installation and Maintenance Instructions.” If the predefined keypad configurations are not adequate, a variety of system features can be programmed with the Pathfinder Configuration Software from a computer via a USB cable that connects to the controller. Programming does not require disassembling or removing any hardware from the vehicle. Remove power to the controller when programming via USB. The ignition feature is programmable only using the Pathfinder Configuration Software.

The +BAT power for the Convergence Controller comes from a power connector next to the controller or through the CAT5 cable. The latter requires a proper switch setting on the light bar controller PCB. To conserve the vehicle battery when the ignition is off, a built-in ignition timer turns off the light bar after a programmed number of hours has lapsed.

In order to accommodate user preference and available light bar options, one of several predefined keypad configurations can be selected after entering the Keypad Selection Mode. Each keypad has between one and three flashing modes, producing distinct flash patterns. The flash patterns associated with each mode can be changed after entering the Flash Programming Mode. The remaining switches (buttons or slide switch) activate additional light bar functions, such as front or rear cutoff, takedowns or work lights, alley lights, low power, and directional signals.

Compatible light bars include full featured, serially-controlled Federal Signal Legend®, Valor®, Allegiant™, Navigator®, Integrity®, and CN SignalMaster® as well as the SpectraLux®

Overview

ILS Series of interior-mounted light bars. In addition, flash rates and patterns, light bar dimming, external SignalMaster® control and other options can be programmed with the Pathfinder Configuration Software.

Programmable Input Circuits

The Convergence Controller has connections for power and ignition detect. Ignition is an active-high only input.

LED Indicators and Visual Diagnostics

All buttons on the Convergence Controller glow when the system is on. Pressed buttons turn bright to indicate that the function they control is active. LEDs on the top of the keypad mimic these active SignalMaster patterns: Left, Right, Center-Out, and Warn. On six-button models, an LED glows over the position in which the slide switch is placed.

Table 1 - System Specifications

Input Voltage	11 Vdc to 28 Vdc
Polarity	Negative ground only
Operating Temperature Range	-40°C to +65°C (-40°F to +149°F)
Standby Current	Less than 0.1 A
Max Input Current	2 A
Four-Button	
Height	1.6 in (4.1 cm)
Depth (to keypad)	1.0 in (2.5 cm)
Length	3.5 in (8.9 cm)
Net Weight	0.11 lb (49.9 g)
Six-Button	
Height	2.8 in (7.1 cm)
Depth (to keypad)	1.1 in (2.8 cm)
Depth (to slide switch)	2.0 in (5.1cm)
Length	2.6 in (6.6 cm)
Net Weight	0.18 lb (81.6 g)

Nine-Button	
Height	2.8 in (7.1 cm)
Depth (to keypad)	1.1 in (2.8 cm)
Length	2.6 in (6.6 cm)
Net Weight	0.18 lb (81.6 g)

Tables 2-4 list the parts included with the kit. After unpacking the kit, examine it for damage that may have occurred in transit. If the product has been damaged, file a claim immediately with the carrier stating the extent of damage. Carefully check all envelopes, shipping labels, and tags before removing or destroying them. Ensure that all parts in the packing list are included in the shipment. If any parts are missing, call Federal Signal Customer Support at 1-800-264-3578, 7 a.m. to 5 p.m., Monday through Friday, Central Time.

Table 2 - Four-Button Kit Contents

Qty	Item Number	Item Description
1	17501957	Convergence Controller Wire Assembly
1	17501813	A Male to Mini-B USB 2.0 Cable
1	8550A100	Loop Strip
1	8550A101	Hook Strip
1	8572294	Insert Legends
1	862302836	Four-Button Convergence Assembly
1	8623129	Swivel Mount Kit

Table 3 - Six-Button Kit Contents

Qty	Item Number	Item Description
1	17501957	Convergence Controller Wire Assembly
1	17501813	A Male to Mini-B USB 2.0 Cable
4	7011232-05	#4 Thread-Forming, Black Phosphate Screw
1	8550A100	Loop Strip
1	8550A101	Hook Strip
1	8572294	Insert Legends
1	862302919	Six-Button Convergence Assembly
2	862302918	Mounting Clip
1	8623129	Swivel Mount Kit

Overview

Table 4 - Nine-Button Kit Contents

Qty	2nd Item Number	Item Description
1	17501957	Convergence Controller Wire Assembly
1	17501813	A Male to Mini-B USB 2.0 Cable
4	7011232-05	#4 Thread-Forming, Black Phosphate Screw
1	8550A100	Loop Strip
1	8550A101	Hook Strip
1	8572294	Insert Legends
1	862302920	Nine-Button Convergence Assembly
2	862302918	Mounting Clip
1	8623129	Swivel Mount Kit

Mounting the Convergence Controllers

Several methods to mount the controllers are available. They are supplied with two mounting methods: a Swivel Mount or a Hook and Loop Mount. A hinged bracket mount is also available for the six- and nine-button controllers, but it is not included. The mounting method used will depend on the chosen mounting location, available room, and user preference.

WARNING

MOUNTING PRECAUTION: Unreliable switch activation and loss of “tactile feedback” will result if the method of mounting the Convergence Controller allows movement. DO NOT mount the Convergence Controller on padded surfaces. Failure to heed this warning could result in driver distraction or driver error while operating the vehicle.

WARNING

AIRBAG DEPLOYMENT: Do not install equipment or route wiring in the deployment path of an airbag. Failure to observe this warning will reduce the effectiveness of the airbag or potentially dislodge the equipment, causing serious injury to you or others.

Choose a location that allows the vehicle and controls to be operated safely at all times.

Mounting the Convergence Controllers

Swivel Mounting

To swivel mount:

1. (Six- and nine-button only) Using Figure 1 as a guide, loosely install the mounting clips to the back of the Convergence Controller housing. When installed properly, the beveled edges of the clips will be toward the center on the housing as illustrated. Slide the swivel mount into place and tighten the clips, making sure that the swivel mount is able to be removed. Do not overtighten screws.

Figure 1 - Swivel Mount

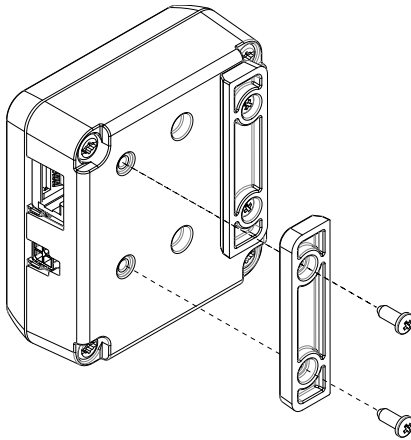

2. (Four-button only) Slide the swivel mount into place.
3. Remove the swivel mount assembly and set the Convergence Controller to the side.
4. Using the swivel mount assembly as a guide, scribe the three drill-position marks at the selected mounting location.

NOTICE

DRILLING PRECAUTIONS: Before drilling holes, check the area into which you are drilling to be sure you do not damage vehicle components while drilling. All wire routings going through drilled holes should be protected by a grommet or convoluted/ split loom tubing.

Mounting the Convergence Controllers

5. Drill three 1/8-inch mounting holes at the marked positions.
6. Secure the swivel mount assembly to the mounting surface with the provided screws. Do not overtighten the screws. See Figure 2.

Figure 2 - Secure to Mounting Surface

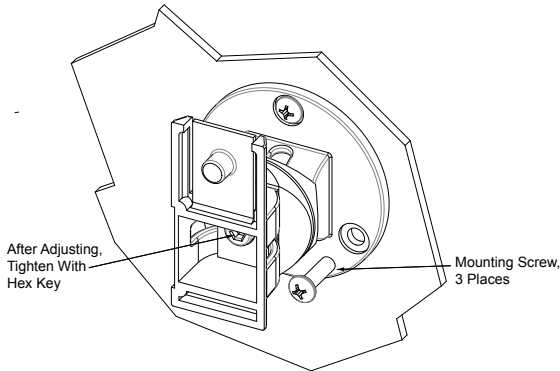

7. Adjust the swivel mount assembly to allow for maximum access to the Convergence Controller.
8. Once in desired location, tighten using a 3 mm hex key. A 7/64-inch hex key will also work.
9. Slide the Convergence Controller onto the swivel mount assembly.

Hook and Loop Mounting

The hook and loop mounting method is intended for storing the Convergence Controller when it is not in use. The hook-and-loop material may not provide sufficient rigidity for proper Convergence Controller operation.

To hook and loop mount:

1. Locate a suitable mounting location for the Convergence Controller.

NOTE: The hook-and-loop pads' mounting surfaces must be clean and dry for proper adhesion. If necessary, use isopropyl alcohol and water to clean the mounting surfaces.

Overview

- 2.** Remove the paper backing from the hook pad and affix it to the back of the Convergence Controller.
- 3.** Remove the paper backing from the loop pad and affix it to the mounting surface.
- 4.** Place the Convergence Controller in position by mating the hook and loop surfaces.

Wiring the Convergence Controllers

⚠ WARNING

HIGH CURRENT ARCING: Do not connect this system to the vehicle battery until ALL other electrical connections are made and you have verified that no shorts exist. High current conductors can cause hazardous sparks or burning wire resulting in electrical fires.

⚠ WARNING

DRILLING PRECAUTIONS: When drilling into a vehicle structure, be sure that both sides of the surface are clear of anything that could be damaged. All drilled holes should be deburred and all sharp edges should be smoothed. All wires going through drilled holes should be protected by a grommet or convolute/split-loom tubing. Additionally, all exterior drilled holes must be sealed with Motorcraft seam sealer T-A-2-B or equivalent to prevent the potential exposure to carbon monoxide or other potentially harmful fumes. Failure to observe this warning could cause serious injury or death.

Read and understand all instructions included with related equipment before installing it. Ensure that all wiring is protected from damage during normal operation of the vehicle and away from any sharp edges and screws. Splice joints should be soldered or crimped with butt-connectors, and properly insulated. Splice joints that will be exposed to the elements should be adequately sealed and insulated. All wires that are extended should not be a lesser gauge than its original mating wire. Make sure that connections are easily accessible for assembly and service.

Power Connections

Table 5 - Ignition Power Wiring

Color	Connection
Red	+BAT
Orange	+IGN
Black	GND

Wiring the Convergence Controllers

The +BAT power for the Convergence Controller comes either from the power connector or through the Convergence cable. The first case (Ignition Power) is used when the +BAT power for the light bar is always connected to the battery, regardless of the ignition switch. The +BAT power after the ignition switch must then be connected to the supplied cable assembly, which mates with the connector on the right side of the Convergence Controller, next to the computer connector. This case requires that the switches on the light bar controller PCBA be in the OFF Position. This arrangement will cut the light bar power when ignition is off. (See the light bar instructions for further details about the switches.)

The second case (Convergence Power) is used when the +BAT power for the light bar has a relay activated by ignition switch. This case requires that the switches on the light bar controller PCBA be in ON Position. (See the light bar instructions for further details about the jumpers.)

Convergence Controller Connection

The connection between the Convergence Controller and the light bar is through a CAT5 cable, which is part of the light bar.

To connect the Convergence Controller:

- 1.** Route the cable from the light bar to the desired Convergence Controller location. (See the light bar instructions for further details.) Secure the cable with user-supplied clamps and hold downs as required.
- 2.** Insert the connector into the receptacle on the side of the Convergence Controller. Secure it with user-supplied clamps and/or wire ties to provide strain relief.

Operating the Convergence Controller

Table 6 - Modes and Flash Patterns

Mode 1	Mode 2	Mode 3
Patterns 1-9	Patterns 10-18	Patterns 19-28

The Convergence Controllers are programmed with a default configuration that you can use to quickly check your initial installation system before configuring the system. Test all vehicle functions, including horn operation, vehicle safety functions, and vehicle lighting systems, for proper operation. Ensure that the installation has not affected the vehicle operation or changed any vehicle safety functions or circuits. Do not test the sound and light system of the vehicle while driving. Operating the vehicle warning system may pose a hazard to the operator and other drivers if the system does not function as expected. Test the vehicle only in a controlled environment. After testing is complete, provide a copy of this manual to the instructional staff and all operating personnel.

The Convergence Controller is shipped fully programmed with default keypad functions and flash patterns. No further programming is necessary unless a change from the default configuration is desired. (See the Keypad Selection section for your controller.) With proper connections, at power up, the Convergence Controller first lights up the button corresponding to the active keypad number. After that, all buttons light up dimly until pressed.

A press of a button sends a command function to the light bar, a buzzer beeps, and the button lights up to its full brightness. A second press of a button turns the button off. Step through functions require multiple presses of the same button to scroll through two or more functions assigned to the button. Some buttons are dependent, which means they can be turned off by pressing another button. The dependent button functions include Flashing Modes and Directional Signals.

If the default configurations do not meet your needs, use the Pathfinder Configuration Software to create your own custom configuration. Pathfinder Configuration Software is available

Operating the Convergence Controller

as a download from the Federal Signal website; Convergence Controller configurations can be created via a laptop computer. Configured programs can be extracted, modified, and stored for ease of service and reuse. Simply connect the Convergence Controller to a PC and download the functions of the programmed software via USB.

Four-Button Convergence Controller

Four-Button Operation

The Convergence Controller is shipped fully programmed with default keypad functions and flash patterns. No further programming is necessary unless a change from the default configuration is desired. (See Four-Button Keypad Selection.) The buttons are positioned 1 through 4 from left to right. With proper connections at power up, the Convergence Controller first lights up either button 1, 2, or 3 bright white corresponding to the active keypad number. Button 4 will display a color of green for configurations 1 through 3 or amber for configurations 4 through 6. After 2 seconds, the Convergence Controller will then beep and display dim red, indicating it is ready for operation.

Figure 3 - Four-Button Keypad

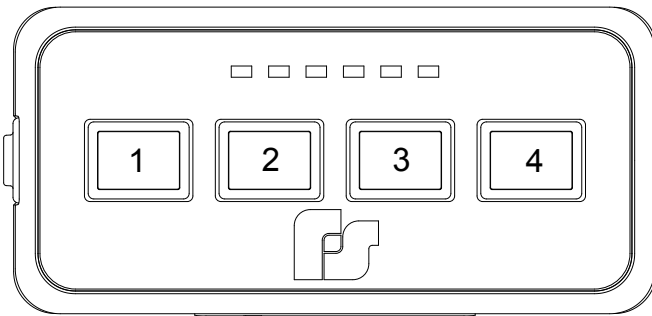

Four-Button Keypad Selection

To select one of the six predefined keypad configurations, enter Keypad Select Mode by simultaneously pressing the first three buttons on the Convergence Controller (Buttons 1, 2, and 3). The Convergence Controller will transition buttons 1 through 3 to the color blue and button 4 to green to indicate Keypad Selection mode has been entered. When button 4 is illuminating green, buttons 1 through 3 represent a keypad configuration 1 through 3 respectively. To access configurations 4 through 6, press button 4, which will transition to an amber color. Select the keypad configuration by pressing either button 1, 2, or 3. Once a keypad configuration is selected, it will transition to white to confirm the request. The Convergence Controller will then reset and return to Operation Mode. Note that the Convergence Controller will time out after 15 seconds if no activity is detected.

Four-Button Convergence Controller

4 Button Flash Pattern Selection

The Convergence Controller has one or two buttons assigned to activate the light bar flashing modes. Nine flash patterns are available for Modes 1 and 2, and eight patterns for Mode 3.

To assign a flash pattern to a mode button, press buttons 2, 3, and 4 simultaneously. Buttons 1 and/or 2, and/or 3 will illuminate an amber color, depending on the number of modes defined for the keypad configuration. Button 1 is used to designate Mode 1, button 2 for Mode 2 and button 3 for Mode 3. To change the flash pattern on a mode button, press the button repeatedly and observe the flash pattern on the light bar. When the desired pattern is flashing, press another button available for programming. Once all available buttons have the desired flash patterns, exit programming mode by either removing power or allowing the Convergence Controller to time out after 15 seconds.

Four-Button Dimming Selection

To select an alternate Convergence Controller dimming level, simultaneously press buttons 1 and 4. Button 1 of the Convergence Controller will begin flashing. Press the button repeatedly and observe the dim level on the Convergence Controller. Once the desired level has been selected, either remove power or allow the Convergence Controller to time out after 15 seconds.

Valor/Integrity/Allegiant Light Bars

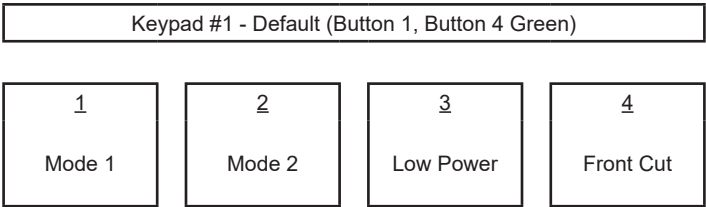

Four-Button Convergence Controller

Keypad #2 (Button 2, Button 4 Green)

<u>1</u> Mode 1/ Mode 2*	<u>2</u> Left Scene/ Right Scene/ Full*	<u>3</u> Work Light + Bed Light	<u>4</u> Left Alley/ Right Alley*
--------------------------------	--	---------------------------------------	---

Keypad #3 (Button 3, Button 4 Green)

<u>1</u> Mode 1	<u>2</u> L/R/CO*	<u>3</u> Work Light + Bed Light	<u>4</u> Left Alley/ Right Alley*
--------------------	---------------------	---------------------------------------	---

Keypad #4 (Button 1, Button 4 Amber)

<u>1</u> Mode 1 + Aux 1	<u>2</u> Work Light + Bed Light	<u>3</u> Takedown	<u>4</u> Low Power
-------------------------------	---------------------------------------	----------------------	-----------------------

Keypad #5 (Button 2, Button 4 Amber)

<u>1</u> Mode 1 + Aux 1	<u>2</u> Mode 2 + Aux 1 & 2	<u>3</u> Flashing White	<u>4</u> Work Light + Bed Light
-------------------------------	-----------------------------------	-------------------------------	---------------------------------------

Keypad #6 (Button 3, Button 4 Amber)

<u>1</u> Mode 1/ Mode 2 with Flashing White*	<u>2</u> L/R/CO*	<u>3</u> Left Scene/ Right Scene/ Full*	<u>4</u> Low Power
--	---------------------	--	-----------------------

* Indicates step through

Six-Button Keypad Selection

Six-Button Convergence Controller

Six-Button Operation

The Convergence Controller is shipped fully programmed with default keypad functions and flash patterns. No further programming is necessary unless a change from the default configuration is desired. (See Six-Button Keypad Selection.) The buttons are positioned 1 through 6 from upper left to lower right. With proper connections at power up, the Convergence Controller first lights up a button bright white corresponding to the active keypad number. If none of the slide switch indicators are illuminated the button represents a keypad configuration for the Valor/Integrity/Allegiant light bars. If the slide switch position 1 indicator is on, the illuminated button represents keypad configuration for the Legend light bar. Likewise, if the slide switch position 2 indicator is on, the illuminated button represents a keypad configuration for the Navigator light bar. After 2 seconds, the Convergence Controller will then beep and display dim red, indicating it is ready for operation.

Figure 4 - Six-Button Keypad

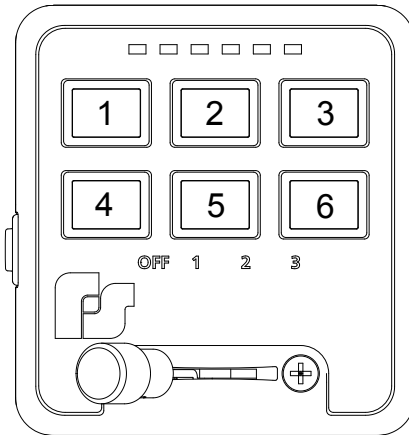

Six-Button Keypad Selection

To select one of the 18 predefined keypad configurations, enter Keypad Select Mode by simultaneously pressing the first three buttons on the Convergence Controller (Buttons 1, 2, and 3). The Convergence Controller will transition all buttons to the color blue to indicate Keypad Selection Mode has been entered. To

access Valor/Integrity/Allegiant light bar configurations, set the slide switch to the off position. To access the Legend light bar configurations set the slide switch to position 1. Likewise, to access Navigator light bar configurations set the slide switch to position 2. Select the keypad configuration by pressing a button associated with the desired keypad configuration. Once a keypad configuration is selected, it will transition to white to confirm the request. The Convergence Controller will then reset and return to Operation Mode. Note that the Convergence Controller will time out after 15 seconds if no activity is detected.

Six-Button Flash Pattern Selection

The Convergence Controller has between one and three switches assigned to activate the light bar flashing modes. These switches may be buttons or the slide switch. Nine flash patterns are available for Modes 1 and 2, and eight patterns for Mode 3.

To assign a flash pattern to a mode button, press buttons 4, 5, and 6 simultaneously. Buttons 1, 2, and/or 3 will illuminate an amber color, depending on the number of modes defined for the keypad configuration. Button 1 is used to designate Mode 1, button 2 for Mode 2 and button 3 for Mode 3. To change the flash pattern on a mode button, press the button repeatedly and observe the flash pattern on the light bar. When the desired pattern is flashing, press another button available for programming. Once all available buttons have the desired flash patterns, exit the programming mode by either removing power or allowing the Convergence Controller to time out after 15 seconds.

Six-Button Dimming Selection

To select an alternate Convergence Controller dimming level, simultaneously press buttons 1 and 3. Button 1 of the Convergence Controller will begin flashing. Press the button repeatedly and observe the dim level on the Convergence Controller. Once the desired level has been selected either remove power or allow the Convergence Controller to time out after 15 seconds.

Six-Button Keypad Selection

Six-Button Configurations

Valor/Integrity/Allegiant Light Bars

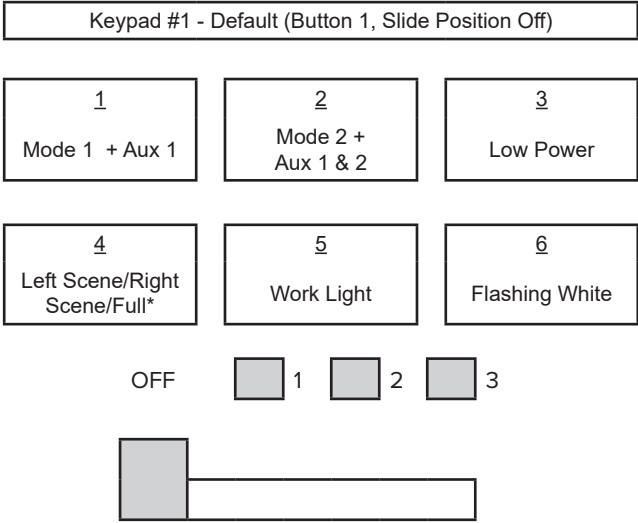

SignalMaster Slide Switch Left, Center Out, Right

* Indicates step through

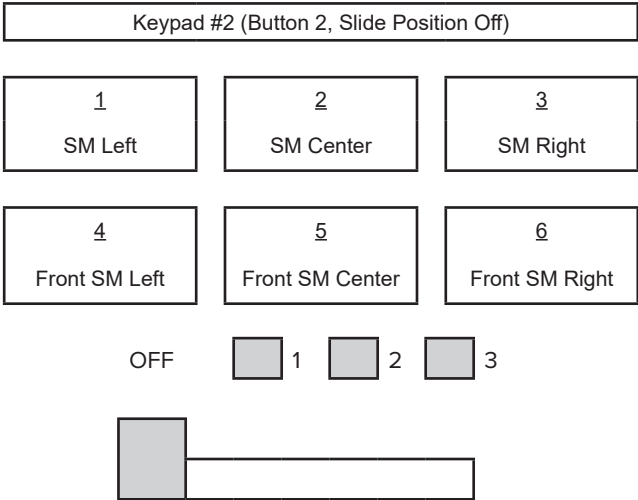

MODE 1 + AUX 1, MODE 2 + AUX 2, MODE 3 + AUX 1-2

* Indicates step through

Six-Button Keypad Selection

Keypad #3 (Button 3, Slide Position Off)

1 Mode 1	2 Mode 2 + Aux 1 & 2	3 Left Alley/Right Alley/Takedown*
-------------	----------------------------	--

4 Left Scene/Right Scene/Full*	5 Work Light + Bed Light	6 Low Power
--------------------------------------	--------------------------------	----------------

OFF  1  2  3

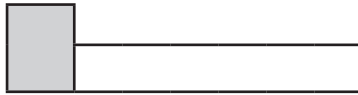



SignalMaster Slide Switch Left, Center Out, Right

* Indicates step through

Keypad #4 (Button 4, Slide Position Off)

1 Mode 1	2 Mode 2	3 Mode 3 + Flashing White
-------------	-------------	---------------------------------

4 Left Scene/Right Scene/Full*	5 Work Light + Bed Light	6 Low Power
--------------------------------------	--------------------------------	----------------

OFF  1  2  3

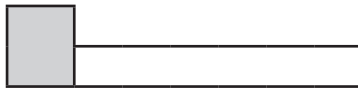

SignalMaster Slide Switch Left, Center Out, Right

* Indicates step through

Six-Button Keypad Selection

Keypad #5 (Button 5, Slide Position Off)

<p><u>1</u></p> <p>Mode 1</p>	<p><u>2</u></p> <p>Mode 2 + Aux 1 + Flashing White</p>	<p><u>3</u></p> <p>Low Power</p>
<p><u>4</u></p> <p>Left Scene/Right Scene/Full*</p>	<p><u>5</u></p> <p>Work Light + Bed Light</p>	<p><u>6</u></p> <p>Front Cutoff</p>

OFF 1 2 3

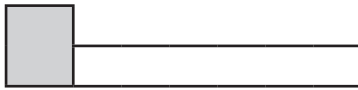

SignalMaster Slide Switch Left, Center Out, Right

* Indicates step through

Keypad #6 (Button 6, Slide Position Off)

<p><u>1</u></p> <p>Mode 1 + Aux 1</p>	<p><u>2</u></p> <p>Mode 2 + Aux 2</p>	<p><u>3</u></p> <p>Low Power</p>
<p><u>4</u></p> <p>Left Scene/Right Scene/Full*</p>	<p><u>5</u></p> <p>Work Light + Bed Light</p>	<p><u>6</u></p> <p>Cruise Ends/ Cruise Entire Bar*</p>

OFF 1 2 3

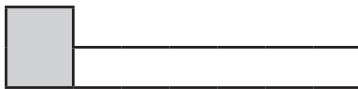

SignalMaster Slide Switch Left, Center Out, Right

* Indicates step through

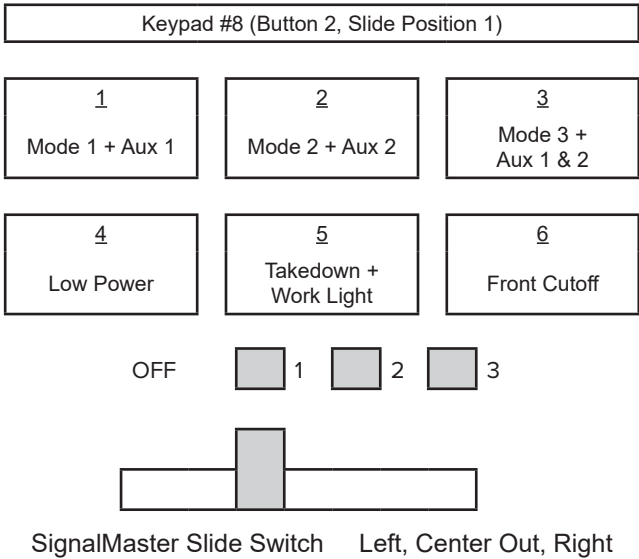
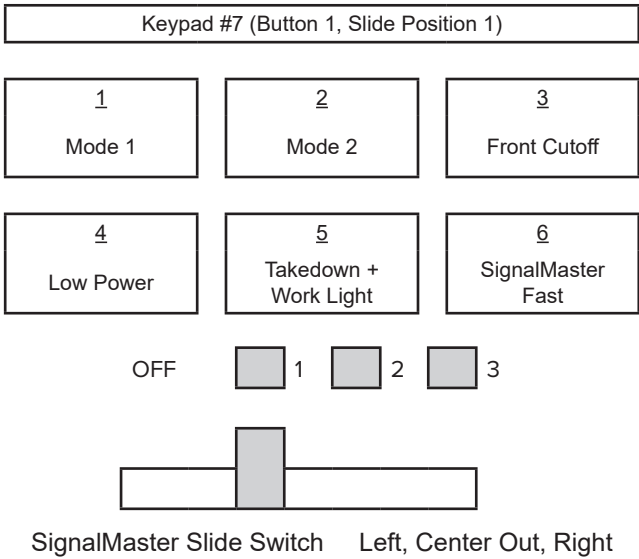

Legend Light Bar



Six-Button Keypad Selection

Keypad #9 (Button 3, Slide Position 1)

1 Mode 1	2 Mode 2 + Aux 1 & 2	3 Low Power
4 Takedown + Work Light	5 Left Alley/ Right Alley*	6 Aux 1

OFF  1  2  3





SignalMaster Slide Switch Left, Center Out, Right

* Indicates step through

Keypad #10 (Button 4, Slide Position 1)

1 Mode 1	2 Left Alley/Right Alley/Takedown*	3 Flashing White
4 Low Power	5 SignalMaster Fast	6 Front Cutoff

OFF  1  2  3



SignalMaster Slide Switch Left, Center Out, Right



* Indicates step through

Six-Button Keypad Selection

Keypad #11 (Button 5, Slide Position 1)

1 Mode 1	2 Mode 2	3 Aux 1
-------------	-------------	------------

4 Flashing White	5 Left Alley/Right Alley/Takedown*	6 Front/Rear Cutoff*
---------------------	---------------------------------------	-------------------------

OFF  1  2  3

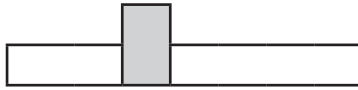



SignalMaster Slide Switch Left, Center Out, Right

* Indicates step through

Keypad #12 (Button 6, Slide Position 1)

1 Mode 1	2 Mode 2	3 Aux 1 & 2
-------------	-------------	----------------

4 Low Power	5 Left Alley/Right Alley/Takedown*	6 Front/Rear Cutoff*
----------------	---------------------------------------	-------------------------

OFF  1  2  3

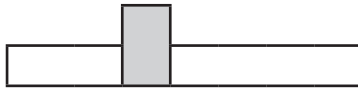

SignalMaster Slide Switch Left, Center Out, Right

* Indicates step through

Six-Button Keypad Selection

Navigator Light Bar

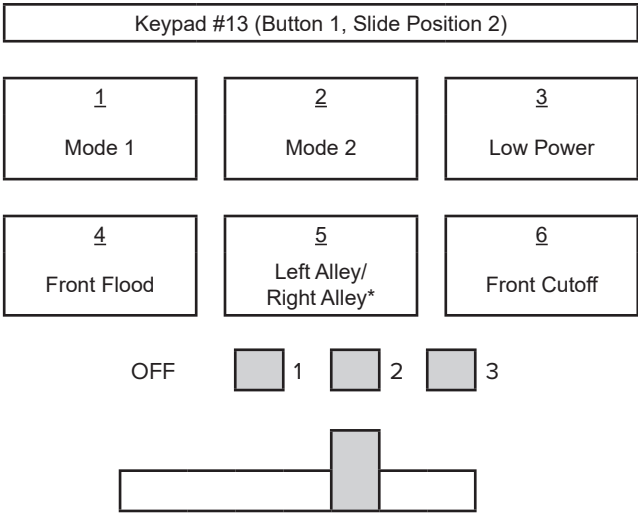

SignalMaster Slide Switch Left, Center Out, Right

* Indicates step through

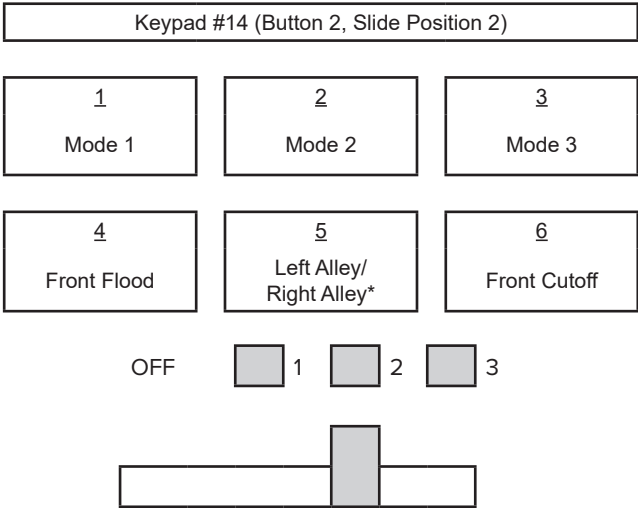

SignalMaster Slide Switch Left, Center Out, Right



* Indicates step through

Six-Button Keypad Selection

Keypad #15 (Button 3, Slide Position 2)

<u>1</u> Mode 1	<u>2</u> Mode 2	<u>3</u> Low Power
--------------------	--------------------	-----------------------

<u>4</u> Front Flood	<u>5</u> Rear Flood	<u>6</u> Flashing White
-------------------------	------------------------	----------------------------

OFF  1  2  3





SignalMaster Slide Switch Left, Center Out, Right

Keypad #16 (Button 4, Slide Position 2)

<u>1</u> Mode 1	<u>2</u> Mode 2	<u>3</u> Front Flood
--------------------	--------------------	-------------------------

<u>4</u> Aux 1	<u>5</u> Aux 2	<u>6</u> Rear Flood
-------------------	-------------------	------------------------

OFF  1  2  3



SignalMaster Slide Switch Left, Center Out, Right

Six-Button Keypad Selection

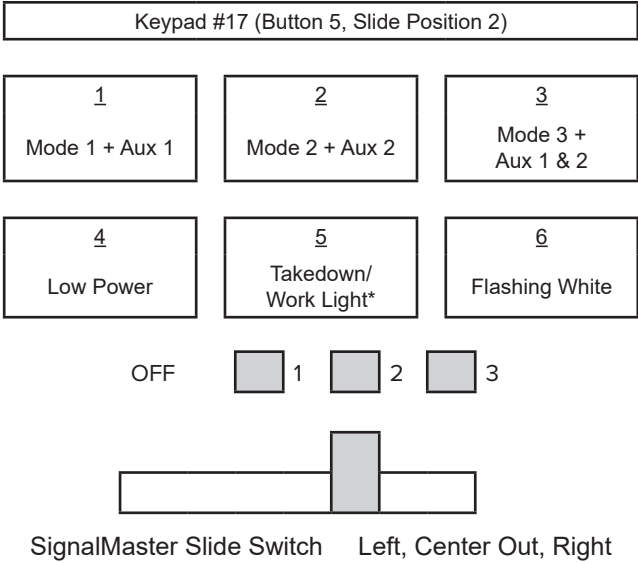

* Indicates step through

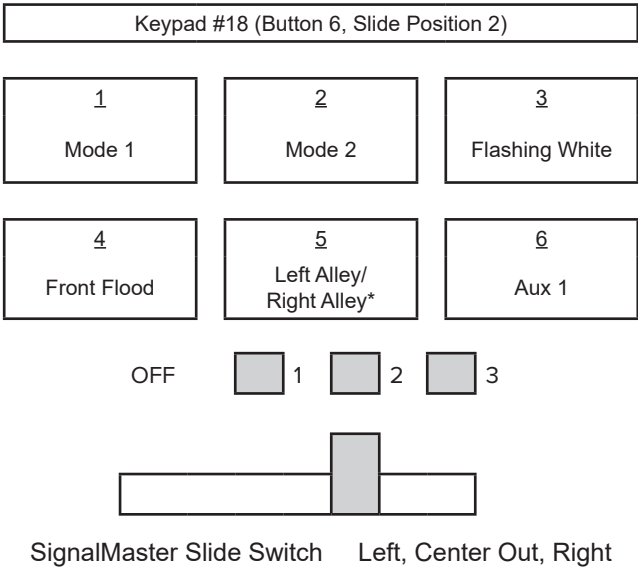

* Indicates step through

Nine-Button Convergence Controller

Nine-Button Operation

The Convergence Controller is shipped fully programmed with default keypad functions and flash patterns. No further programming is necessary unless a change from the default configuration is desired. (See Nine-Button Keypad Selection). The buttons are positioned 1 through 9 from upper left to lower right. With proper connections at power up, the Convergence Controller first lights up a button bright white corresponding to the active keypad number. After 2 seconds, the Convergence Controller will then beep and display dim red indicating it is ready for operation.

Figure 5 - Nine-Button Keypad

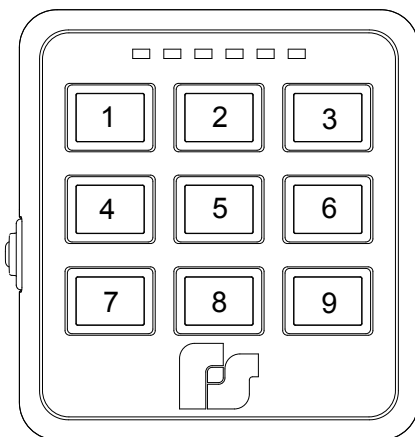

Nine-Button Keypad Selection

To select one of the six predefined keypad configurations, enter Keypad Select Mode by simultaneously pressing the first three buttons on the Convergence Controller (Buttons 1, 2, and 3). The Convergence Controller will transition buttons 1 through 6 to the color blue to indicate Keypad Selection Mode has been entered. Select the keypad configuration by pressing a button associated with the desired keypad configuration. Once a keypad configuration is selected, it will transition to white to confirm the request. The Convergence Controller will then reset and return to Operation Mode. Note that the Convergence Controller will timeout after 15 seconds if no activity is detected.

Nine-Button Convergence Controller

Nine-Button Flash Pattern Selection

The Convergence Controller has between one and three buttons assigned to activate the light bar flashing modes. Nine flash patterns are available for Modes 1 and 2, and eight patterns for Mode 3.

To assign a flash pattern to a mode button, press buttons 4, 5, and 6 simultaneously. Buttons 1, 2, and/or 3 will illuminate an amber color depending on the number of modes defined for the keypad configuration. Button 1 is used to designate Mode 1, button 2 for Mode 2 and button 3 for Mode 3. To change the flash pattern on a mode button, press the button repeatedly and observe the flash pattern on the light bar. When the desired pattern is flashing, press another button available for programming. Once all available buttons have the desired flash patterns, exit the programming mode by either removing power, or allowing the Convergence Controller to time out after 15 seconds.

Nine-Button Dimming Selection

To select an alternate Convergence Controller dimming level, simultaneously press buttons 1 and 3. Button 1 of the Convergence Controller will begin flashing. Press the button repeatedly and observe the dim level on the Convergence Controller. Once the desired level has been selected, either remove power or allow the Convergence Controller to time out after 15 seconds.

Nine-Button Convergence Controller

Valor/Integrity/Allegiant Light Bars

Keypad #1 - Default (Button 1)		
<u>1</u> Mode 1 + Aux 1	<u>2</u> Mode 2 + Aux 1 & 2	<u>3</u> Low Power
<u>4</u> Left Scene/Right Scene/Full*	<u>5</u> Work Lights	<u>6</u> Flashing White
<u>7</u> SM Left	<u>8</u> SM Center Out	<u>9</u> SM Right

* Indicates step through

Keypad #2 (Button 2)		
<u>1</u> Mode 1 + Aux 1	<u>2</u> Mode 2 + Aux 2	<u>3</u> Mode 3 + Aux 1 & 2
<u>4</u> Front SM Left	<u>5</u> Front SM Center	<u>6</u> Front SM Right
<u>7</u> Rear SM Left	<u>8</u> Rear SM Center Out	<u>9</u> Rear SM Right

Nine-Button Convergence Controller

Keypad #3 (Button 3)		
1 Mode 1 + Aux 1	2 Mode 2 + Aux 1 & 2	3 Left Alley/Right Alley/Takedown*
4 Left Scene/Right Scene/Full*	5 Work Light	6 Bed Light
7 L/R/CO*	8 Low Power	9 Front Cutout

* Indicates step through

Keypad #4 (Button 4)		
1 Mode 1 + Aux 1	2 Mode 2 + Aux 2	3 Mode 3 + Flashing White + Aux 1 & 2
4 Left Scene/Right Scene/Full*	5 Work Light + Bed Light	6 Low Power
7 SM Left	8 SM Center Out	9 SM Right

Nine-Button Convergence Controller

Keypad #5 (Button 5)

<u>1</u> Mode 1	<u>2</u> Mode 2 + Aux 1 + Flashing White	<u>3</u> Low Power
<u>4</u> Front Flood	<u>5</u> Work Light	<u>6</u> Bed Light
<u>7</u> SM Left	<u>8</u> SM Center Out	<u>9</u> SM Right

Keypad #6 (Button 6)

<u>1</u> Mode 1 + Aux 1	<u>2</u> Mode 2 + Aux 2	<u>3</u> Low Power
<u>4</u> Takedown	<u>5</u> Work Light	<u>6</u> Bed Light
<u>7</u> Right Alley	<u>8</u> Left Alley	<u>9</u> Cruise Ends

Testing the System

⚠ WARNING

SOUND HAZARD: All effective sirens and horns produce loud sounds (120 dB) that may cause permanent hearing loss. Always minimize your exposure to siren sound and wear hearing protection. Do not sound the siren indoors or in enclosed areas where you and others will be exposed to the sound.

After the installation, test the emergency warning system to ensure that it is operating properly. Also test all vehicle functions, including horn operation, vehicle safety functions, and vehicle lighting systems to ensure proper operation. Ensure that the installation has not affected the vehicle operation or changed any vehicle safety functions or circuits. After testing is complete, provide a copy of these instructions to the instructional staff and all operating personnel.

Do not test the sound and light system of the vehicle while driving. Operating the vehicle warning systems may pose a hazard to the operator and other drivers if the systems do not function as expected. Test the vehicle only in a controlled environment.

Convergence Controller Legends and Safety Messages

To complete the installation, the kit includes:

- Two scored sheets of replaceable keypad legends that identify the functions of the Convergence Controller buttons.
- A scored sheet of two labels with precautions to guard against hearing loss when operating the siren (part no. 1612339).
- A safety message card for operators of Federal Signal Sound and Light System (part no. 256B691).

Applying the Replaceable Convergence Controller Legends

To apply the legends:

1. Peel the appropriate legends from the sheet and apply them to the Convergence Controller buttons.
2. Verify that the label is properly tucked under the retaining ridge on the button.

Figure 6 - Replacing Legends

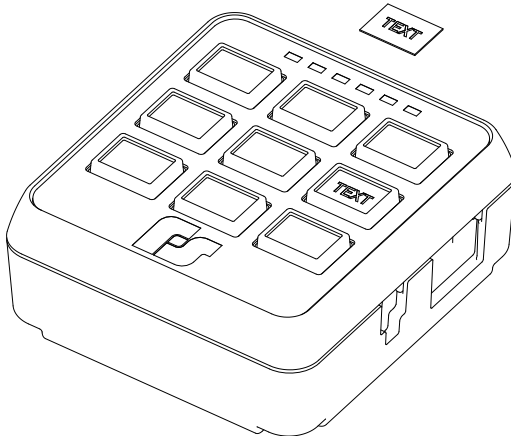

Getting Repair Service

Getting Technical Support

For technical support, please contact:

Federal Signal Corporation

Phone: 1-800-443-9132

Fax: 1-800-343-9706

Email: empserviceinfo@fedsig.com

Getting Repair Service

The Federal Signal factory provides technical assistance with

Any units returned to returned to Federal Signal for service, inspection, or repair must be accompanied by a Return Material Authorization (RMA). Obtain an RMA from a Local Distributor or Manufacturer's Representative. Provided a brief explanation of the service requested or the nature of the malfunction.

Address all communications to the following address.

Federal Signal Corporation

Service Department

2645 Federal Signal Drive

University Park IL 60484-3167



FEDERAL SIGNAL
Safety and Security Systems

2645 Federal Signal Drive
University Park, Illinois 60484

www.fedsig.com

Customer Support

Police/Fire-EMS: 800-264-3578 • +1 708 534-3400

Work Truck: 800-824-0254 • +1 708 534-3400

Technical Support 800-433-9132 • +1 708 534-3400

All product names or trademarks are properties of their respective owners.