

25500798 Rev. A2 0423

Safety Message to Installers and Service Personnel of Emergency Vehicle Safety Equipment

⚠ WARNING

People's lives depend on your proper installation and servicing of Federal Signal products. It is important to read and follow all instructions shipped with this product. Listed below are some other important safety instructions and precautions you should follow.

Before Installation or Service

Qualifications

- To properly install or service this equipment, you must have a good understanding of automotive electrical procedures and systems along with proficiency in the installation and service of safety warning equipment. Always refer to the vehicle service manuals when installing equipment on a vehicle.

Electrical Hazards

- Never attempt to install aftermarket equipment that connects to the vehicle wiring without reviewing a vehicle wiring diagram available from the vehicle manufacturer. Ensure that your installation will not affect vehicle operation and safety functions or circuits.

During Installation or Service

- To avoid a battery explosion, always disconnect the negative battery cable first and reconnect it last. Avoid a spark when connecting near or to the battery. The gasses produced by a battery can cause a battery explosion that could result in vehicle damage and serious injury.
- Do not install equipment or route wiring or a plug-in cord in the deployment path of an airbag.
- Before mounting any components, check the manual to ensure that the component you are installing is suitable for use in that area of the vehicle. Many components are not suitable for use in the engine compartment or in other areas subject to extreme environmental exposure.
- When drilling into a vehicle structure, ensure that both sides of the surface are clear of anything that could be damaged. Remove all burrs from drilled holes to prevent electrical shorts, and grommet all drilled holes through which wiring passes. Ensure that mounting screws do not cause electrical or mechanical damage to the vehicle.

After Installation or Service

- If a vehicle seat is temporarily removed, verify with vehicle manufacturer if the seat needs to be recalibrated for proper airbag deployment.
- To ensure proper operation, test all vehicle functions, including horn operation, vehicle safety functions, and vehicle light systems. Ensure that installation has not affected vehicle operation or changed any vehicle safety function or circuit.
- After installation and testing are complete, provide a copy of these instructions to instructional staff and all operating personnel.
- File these instructions in a safe place and refer to them when maintaining and/or reinstalling the product.

Failure to follow all safety precautions and instructions may result in property damage, serious injury, or death.

Unpacking the Product

After unpacking the product, inspect it for damage that may have occurred in transit. If it has been damaged, do not attempt to install or operate it. File a claim immediately with the carrier, stating the extent of the damage. Failure to identify damage before installation could lead to rejection of any claim. Carefully check all envelopes, shipping labels, and tags before removing or destroying them. Ensure that the parts listed in Table 1 are included in the package. If you are missing any parts, contact Federal Signal Customer Support at 1-800-264-3578, 7 a.m. to 5 p.m., Monday through Friday (CT).

Table 1 Kit contents and tools needed (See Figure 1)

Item	Description	Qty.
1	Driver Side Upper Guard Assembly	1
2	Passenger Side Upper Guard Assembly	1
3	5/16-18 x 1.5-inch Hex Head Bolt	4
4	5/16-18 x 1.5-inch Button Head Bolt	6
5	5/16-inch Flat Washer	16
6	5/16-inch Lock Washer	10
7	5/16-inch Hex Nut	10

Figure 1 Kit items

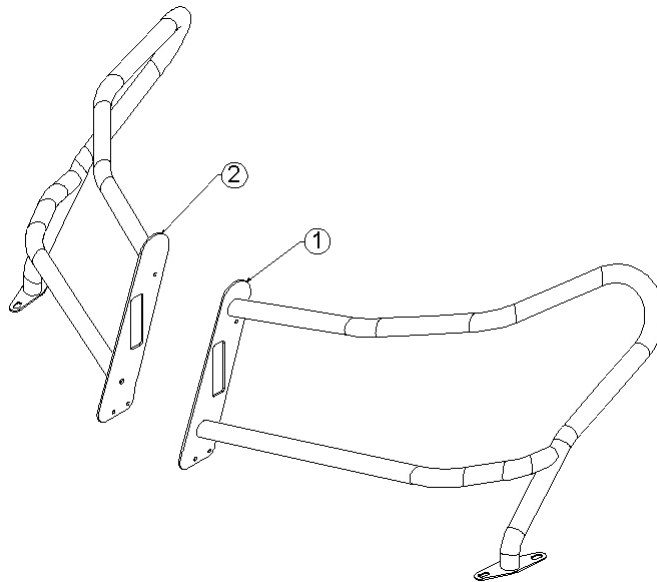

⚠ WARNING

PUSH BUMPER PRECAUTION: Installing a push bumper on a vehicle may raise the vehicle's minimum collision speed for airbag deployment. It is imperative that police officers wear safety belts when operating the motor vehicle. Failure to follow this warning may cause serious injury or death.

NOTICE

THREAD DAMAGE AND GALLING: Use anti-seize lubricant on all stainless steel fasteners to prevent thread damage and galling.

To install the upper guard:

1. Install the push bumper (DFC-PB-FPIU20) and lower guard (DFC-LG-FPIU20) sets to the front of the vehicle. Refer to the 25500796 and 25500797 instruction sheets.

NOTE: The lower guards are necessary to properly install the upper guards.

2. Using the 5/16-inch button head bolts, lock washers, flat washers, and hex nuts, loosely attach the driver side upper guard to the push bumper uprights in the locations shown in figure 2.

Figure 2 Attach to push bumper uprights

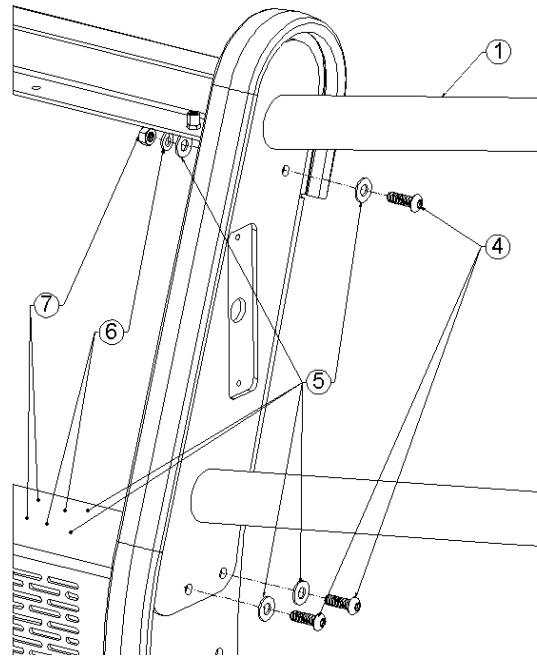

3. Using the 5/16-inch hex head bolts, lock washers, flat washers, and hex nuts, loosely attach the driver side upper guard to the lower guard. See figure 3.

Figure 3 Attach upper guard to lower guard

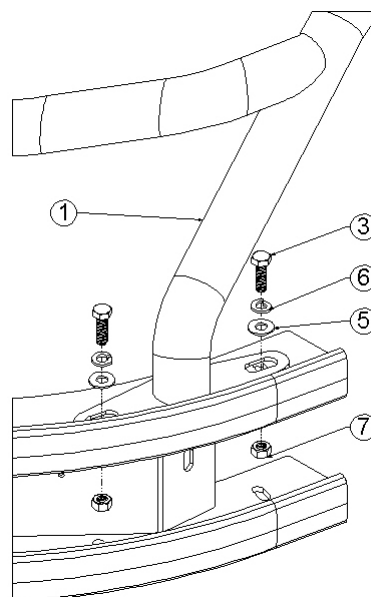

4. Align and adjust the upper guards as necessary, and then tighten and torque (24-28 ft-lb) all fasteners.
5. Repeat steps 2-4 for the passenger side.

Maintaining the Upper Guards

Regularly clean the textured powder coat finishes with either a soft cloth or a brush with a mild soap and warm water. Avoid using any harsh chemicals, as this will damage the product's finish. Pressure washing this product is the most efficient way to remove heavy dirt and grime. The pressure washer should be used on a low pressure setting with filtered water for best results. Using high pressure can damage the product's finish.

Getting Technical Support

For technical support, please contact:

Federal Signal Corporation
Service Department
Phone: 1-800-433-9132
Email: empserviceinfo@fedsig.com

Getting Repair Service

The Federal Signal factory provides technical assistance with any problems that cannot be handled locally. Any product returned to Federal Signal for service, inspection, or repair must be accompanied by a Return Material Authorization (RMA). Obtain an RMA from a local Distributor or Manufacturer's Representative. Provide a brief explanation of the service requested or the nature of the malfunction.

Address all communications and shipments to the following:

Federal Signal Corporation
Service Department
2645 Federal Signal Dr.
University Park, IL 60484-3167



FEDERAL SIGNAL

Safety and Security Systems

2645 Federal Signal Drive
University Park, Illinois 60484-3167

www.fedsig.com

Customer Support

Police/Fire-EMS: 800-264-3578 • +1 708 534-3400

Work Truck: 800-824-0254 • +1 708 534-3400

Technical Support: 800-433-9132 • +1 708 534-3400

© Copyright 2022-2023 Federal Signal Corporation
All trademarks are property of their respective owners.