

# PAGASYS GEN II

Public Address and General Alarm System  
Model: P-SYS-G



---

## ***Description, Installation, Operations and Maintenance Manual***

## Limited Warranty

This product is subject to and covered by a limited warranty, a copy of which can be found at [www.fedsig.com/SSG-Warranty](http://www.fedsig.com/SSG-Warranty). A copy of this limited warranty can also be obtained by written request to Federal Signal Corporation, 2645 Federal Signal Drive, University Park, IL 60484, email to [info@fedsig.com](mailto:info@fedsig.com) or call +1 708-534-3400.

This limited warranty is in lieu of all other warranties, express or implied, contractual or statutory, including, but not limited to the warranty of merchantability, warranty of fitness for a particular purpose and any warranty against failure of its essential purpose.



**FEDERAL SIGNAL**  
Safety and Security Systems

2645 Federal Signal Drive  
University Park, Illinois 60484

[www.fedsig.com](http://www.fedsig.com)

Technical Support      800-524-3021 (US) • +1 708-534-4790 (International)

All product names or trademarks are properties of their respective owners.

---

# Contents

<b>1.0 Safety Messages</b> .....	<b>14</b>
1.1 Hazard Classification.....	15
<b>2.0 General Description</b> .....	<b>16</b>
2.1 Introduction.....	16
2.2 Overview.....	16
2.3 System Architecture.....	16
2.4 Features .....	18
2.5 Components .....	19
2.5.1 PAGASYS GEN II Kits.....	19
2.5.2 Controller Chassis .....	20
2.5.3 System Controller Backplane (20000170).....	21
2.5.4 Controller Backplane Specifications .....	21
2.5.5 Power Supply Card (120/240 Vac) (P-ADPS-G) .....	22
2.5.6 Controller Processor Card (DSP/ARM) (P-CPC-G).....	23
2.5.7 Amplifier Audio Mux Card (P-AAMC-G).....	25
2.5.8 Internal AP Mux Card (P-IAMC-G) .....	26
2.5.9 External AP Mux Card (P-EAMC-G).....	28
2.5.10 Miscellaneous I/O Card (P-CMC-G).....	29
2.5.11 I/O Interface Card (P-IOIC-G).....	30
2.5.12 Amplifier Chassis .....	31
2.5.13 Amplifier Specifications.....	33
2.6 Amplifier Front Panel .....	34
2.6.1 Amplifier Front Chassis.....	35
2.6.2 Amplifier Signal Backplane (20000154).....	36
2.6.3 Amplifier Power Backplane (20000155) .....	37
2.6.4 Amplifier Card (20000150).....	38
2.6.5 ISMT Card (P-ISMT-G).....	39
<b>3.0 I/O and Terminal Block Cards</b> .....	<b>42</b>
3.1 Access Panel Aggregator I/O Cards (P-APIC-G).....	42
3.2 Digital Input I/O Card (P-16DIN-G).....	44
3.2.1 Digital Input Card Specifications (P-16DIN-G) .....	44
3.3 Beacon Monitored Output Module (P-BK-MON-G) .....	45

---

3.3.1 Beacon Monitored Module Specifications (P-BK-MON-G) .....	46
3.4 Relay Output Card (P-SPDT-G) .....	46
3.4.1 Relay Output Card Specifications (P-SPDT-G) .....	47
3.5 Fan Control and Monitoring Card (P-FCMC-G).....	48
3.5.1 Fan Control and Monitoring Card Specifications (P-FCMC-G).....	49
3.6 Monitored Input Module (P-MONIC-G).....	50
3.6.1 Monitored Input Module Specifications (P-MONIC-G).....	51
3.7 Passive Terminal Block Card (P-PTBC-G) .....	51
3.7.1 Passive Terminal Block Card Specifications (P-PTBC-G) .....	52
3.8 Cable Power Injector I/O Card (P-CPIC-G).....	52
3.8.1 Cable Power Injector I/O Card Specifications (P-CPIC-G).....	53
3.9 Amplifier Audio Distribution Terminal Block (P-AADCx-G).....	53
3.9.1 Amplifier Audio Distribution Terminal Block Specifications (P-AADCx-G) .....	55
3.10 Fan Wiring Termination Card (P-FWTC-G) .....	56
3.10.1 Fan Wiring Termination Card Specifications (P-FWTC-G) .....	56
3.11 IS Barrier Board (P-IS-BARRIER-G) .....	56
3.11.1 IS Barrier Board Specifications (P-IS-BARRIER-G) .....	58
3.12 High Integrity Card (P-NPLUS1-G).....	59
3.12.1 High Integrity Card Specifications (P-NPLUS1-G) .....	59
<b>4.0 Access Panels .....</b>	<b>60</b>
<b>5.0 Removing and Installing the Controller Chassis.....</b>	<b>62</b>
5.1 Removing the Controller Chassis .....	62
5.1.1 Removing the front cover .....	62
5.1.2 Removing Power from the Controller Chassis.....	62
5.1.3 Disconnecting the Controller Chassis cables from the Chassis .....	62
5.1.4 Removing the Internal Cards.....	63
5.1.5 Removing the Controller Backplane .....	63
5.2 Installing the Controller Chassis .....	64
5.2.1 Installing the Controller Backplane .....	64
5.2.2 Installing the Internal Cards.....	64
5.2.3 Installing the Controller Chassis .....	65
5.2.4 Installing the Controller Chassis Cables.....	65
5.3 Removing and Installing the Amplifier Chassis (From Cabinet) .....	69

---

---

5.3.1 Safety Instructions .....	69
5.3.2 Recommendation for the Equipment Location .....	69
5.3.3 Preparing Amplifier Installation and Removal.....	69
5.3.4 Removing the Amplifier Chassis.....	69
5.3.5 Installing the Amplifier Chassis.....	70
5.3.6 Replacing the Internal Cards .....	70
5.3.7 Removing the Amplifier Card.....	70
5.3.8 Installing the Amplifier Card.....	71
5.3.9 Removing the ISMT Card (Optional) .....	73
5.3.10 Installing the ISMT Card (Optional) .....	73
<b>6.0 Installing and Configuring the I/O Cards.....</b>	<b>74</b>
6.1 Main Distribution Frame (MDF) .....	74
6.2 Digital Input Card (P-16DIN-G).....	76
6.2.1 Removing the Digital Input Card.....	76
6.2.2 Installing and Configuring the Digital Input Card (P-16DIN-G).....	76
6.3 Beacon Monitored Card (P-BK-MON-G) .....	77
6.3.1 Removing the Beacon Monitored Card (P-BK-MON-G).....	77
6.3.2 Installing and Configuring the Beacon Monitored Card (P-BK-MON-G).....	77
6.4 Relay Output Card (P-SPDT-G) .....	78
6.4.1 Removing the Relay Output Card (P-SPDT-G) .....	78
6.4.2 Installing and Configuring the Relay Output Card (P-SPDT-G).....	79
6.5 Fan Control and Monitoring Card (P-FCMC-G).....	79
6.5.1 Removing the Fan Control and Monitoring Card (P-FCMC-G).....	79
6.5.2 Installing and Configuring the Fan Control and Monitoring Card (P-FCMC-G) .....	80
6.6 Monitored Input Card (P-MONIC-G).....	81
6.6.1 Removing the Monitored Input Card (P-MONIC-G).....	81
6.6.2 Installing and Configuring the Monitored Input Card (P-MONIC-G) .....	81
6.7 Passive Terminal Block Card (P-PTBC-G) .....	82
6.7.1 Removing the Passive Terminal Block Card (P-PTBC-G).....	82
6.7.2 Installing and Configuring the Passive Terminal Block Card (P-PTBC-G).....	82
6.8 Cable Power Injector I/O Card (P-CPIC-G).....	83
6.8.1 Removing the Cable Power Injector I/O Card (P-CPIC-G).....	83
6.8.2 Installing and Configuring the Cable Power Injector I/O Card (P-CPIC-G) .....	83

---

6.9 Amplifier Audio Distribution Cards (P-AADCx-G) .....	84
6.9.1 Removing the Amplifier Audio Distribution Card (P-AADCx-G) .....	84
6.9.2 Installing and Configuring the Amplifier Audio Distribution Cards (P-AADCx-G).....	84
6.10 Fan Wiring Termination Card (P-FWTC-G) .....	85
6.10.1 Removing the Fan Wiring Termination Card (P-FWTC-G) .....	85
6.10.2 Installing and Configuring the Fan Wiring Termination Card .....	85
6.11 IS Barrier Board (P-IS-BARRIER-G) .....	86
6.11.1 Removing the IS Barrier Board (P-IS-BARRIER-G) .....	86
6.11.2 Installing and Configuring the IS Barrier Board .....	86
6.12 High Integrity I/O Board (P-NPLUS1-G).....	87
6.12.1 Removing the High Integrity I/O Board (P-NPLUS1-G) .....	87
6.12.2 Installing and Configuring the High Integrity I/O card .....	87
<b>7.0 PAGASYS GEN II Controller Firmware .....</b>	<b>89</b>
7.1 Updating PAGASYS GEN II Controller.....	89
7.2 Upgrading the Controller Firmware .....	89
<b>8.0 Controller Chassis Operations.....</b>	<b>95</b>
8.1 Configuration .....	95
8.2 Controller Card Real-Time Clock Maintenance .....	95
8.3 Replacing the Controller Card Lithium CR Battery .....	95
<b>9.0 Configuring the Amplifier Chassis .....</b>	<b>96</b>
9.1 Setting the DIP Switches .....	96
9.2 Powering up/Powering down .....	97
9.3 Normal Operations .....	97
9.4 Standby Amplifier Operations and Routing.....	98
9.5 Test Features.....	99
9.6 ISMT Operations (Optional).....	100
<b>10.0 Setting up a Standby Amplifier .....</b>	<b>101</b>
10.1 Defining an Amplifier Chassis 1 as the Standby Amplifier .....	101
<b>11.0 Terminating Speakers to MDF .....</b>	<b>105</b>
11.1 Terminating a speaker to Amplifier Chassis 1, Amplifier 1 .....	105
11.2 Terminating a speaker to Amplifier Chassis 2, Amplifier 2 .....	106
<b>12.0 Terminating ISMT Speakers to MDF .....</b>	<b>108</b>
12.1 Terminate an ISMT speaker to Amplifier Chassis 1, Amplifier 2 .....	108
12.1.1 Discovering ISMT speakers using amplifier diagnostics .....	111

---

---

<b>13.0 Terminating Beacons to MDF .....</b>	<b>112</b>
13.1 Terminate a beacon to the beacon monitored output module .....	112
<b>14.0 Control Panel Designer.....</b>	<b>117</b>
14.1 Adding a new button and LED to a control panel to use a new broadcast .....	117
14.1.1 Configuring a new Access Panel Button.....	118
14.1.2 Creating the new Access Indicator for the Access Panel Button .....	118
14.1.3 Adding the new button an indicator in the Control Panel Designer .....	119
<b>15.0 Configuring a Broadcast.....</b>	<b>120</b>
15.1 Creating a new broadcast for PAGASYS GEN II.....	120
15.2 Adding a new button and LED to a control panel .....	121
<b>16.0 Programming PABX Interface .....</b>	<b>123</b>
16.1 Configuring the Miscellaneous Card.....	123
16.2 Configuring the Miscellaneous Card.....	124
16.3 Analog Extension Mode.....	125
16.4 Loop Start Mode .....	125
<b>17.0 Configuring local speaker mute.....</b>	<b>126</b>
17.1 Configuring local speaker mute to avoid feedback.....	126
<b>18.0 Configuring an Amplifier .....</b>	<b>129</b>
18.1 Creating a new amplifier entity in the equipment tree .....	129
18.2 Configuring a new amplifier entity in the equipment tree .....	130
<b>19.0 Installing Hardware Access Panel .....</b>	<b>132</b>
19.1 Connect Hard Access Panel to the PAGASYS GEN II System.....	132
19.2 Configure the panel in System Manager .....	133
<b>20.0 Ordering PAGASYS GEN II Systems .....</b>	<b>135</b>
20.1 Ordering Standard Cabinets and Accessories.....	135
20.2 Ordering PAGASYS GEN II Service Parts .....	138
<b>21.0 Getting Technical Support.....</b>	<b>139</b>

---

## Figures

Figure 1 PAGASYS GEN II A/B Pair Architecture .....	18
Figure 2 PAGASYS GEN II Kit Solutions .....	19
Figure 3 Controller Chassis (P-NET-G).....	20
Figure 4 System Controller Backplane (20000170) .....	21
Figure 5 Power Supply Card (120/240 Vac)(P-ADPS-G).....	22
Figure 6 Controller Card (DSP/ARM) (P-CPC-G).....	24
Figure 7 Amplifier Audio Mux Card (P-AAMC-G).....	26
Figure 8 Internal AP Mux Card (P-IAMC-G) .....	27
Figure 9 External AP Mux Card (P-EAMC-G).....	28
Figure 10 Miscellaneous I/O Card (P-CMC-G).....	30
Figure 11 I/O Interface Card (P-IOIC-G) .....	31
Figure 12 Amplifier Chassis .....	32
Figure 13 Amplifier Chassis Card Layout (P-A1000-G).....	33
Figure 14 Amplifier Front Panel .....	35
Figure 15 Amplifier Front Chassis .....	36
Figure 16 Amplifier Signal Backplane (20000154).....	36
Figure 17 Amplifier Power Backplane (20000155).....	37
Figure 18 Amplifier Card (20000150) .....	39
Figure 19 ISMT Card (P-ISMT-G) .....	40
Figure 20 ISMT Connector on the Amplifier Signal Backplane.....	41
Figure 21 Access Panel Aggregator I/O Card, RJ45 Connector (P-APIC-G).....	43
Figure 22 Digital Input I/O Card (P-16DIN-G).....	44
Figure 23 Beacon Monitored Output Module (P-BK-MON-G).....	45
Figure 24 Relay Output Card (P-SPDT-G).....	47
Figure 25 Fan Control and Monitoring Card (P-FCMC-G).....	49
Figure 26 Monitored Input Module (P-MONIC-G).....	51



---

Figure 27 Passive Terminal Block Card (P-PTBC-G).....	52
Figure 28 Cable Power Injector I/O Card (P-CPIC-G) .....	53
Figure 29 P-AADC1-G and P-AADC1-G-01 Cards.....	54
Figure 30 P-AADC2-G and P-AADC2-G-01 Cards.....	54
Figure 31 P-AADC4-G and P-AADC4-G-01 Cards.....	55
Figure 32 P-AADC8-G and P-AADC8-G-01 Cards.....	55
Figure 33 Fan Wiring Termination Card (P-FWTC-G) .....	56
Figure 34 IS Barrier Board (P-IS-BARRIER-G) .....	58
Figure 35 High Integrity Card (P-NPLUS1-G).....	59
Figure 36 Picture of Desktop Access Panel.....	60
Figure 37 Breaker Switches.....	62
Figure 38 Card Guides in Controller Chassis .....	64
Figure 39 Cables Connected into RJ45 Jack Socket .....	65
Figure 40 Cables Connected on the Miscellaneous I/O Card.....	66
Figure 41 Cable Connections on the Processor Card .....	67
Figure 42 Internal AP Mux Card Connections.....	67
Figure 43 External AP Mux Card Connections .....	68
Figure 44 Connections.....	68
Figure 45 Front Panel Cable.....	70
Figure 46 Fan Cable .....	71
Figure 47 Amplifier Card in the Top Portion of the Front Plastic Rail .....	71
Figure 48 Metal Handles in the 20-degree and 60-degree Angle .....	72
Figure 49 Lower Transformer Plug .....	72
Figure 50 Two Black Handles on Amplifier Card .....	73
Figure 51 Removing the ISMT Card.....	73
Figure 52 Main Distribution Frame (MDF) .....	74
Figure 53 Areas for Mounting Terminating Equipment.....	75

---

---

Figure 54 Back of Controller Shelf.....	90
Figure 55 View the Ports.....	90
Figure 56 PuTTY Example .....	91
Figure 57 Open the Firmware Folder.....	91
Figure 58 Place all Controller Binary and CRC Files in Root Directory .....	92
Figure 59 Run the Install Application .....	93
Figure 60 Message Now reboot the controller.....	94
Figure 61 Firmware Upgrade is Complete.....	94
Figure 62 Setting Mini DIP Switches.....	96
Figure 63 Jumpers configured to support a Standby Amplifier .....	98
Figure 64 Defining an Amplifier Chassis.....	101
Figure 65 Removing the chassis mounting screws.....	102
Figure 66 Removing the cover screws.....	102
Figure 67 Inserting four jumpers in the left-most position.....	103
Figure 68 Fourth amplifier slot.....	103
Figure 69 Standby amp bus ports on the Amplifier Chassis .....	104
Figure 70 Left (Audio) MDF Panel .....	105
Figure 71 Target amplified audio distribution card (Amp A) .....	106
Figure 72 Amplifier 2 Termination.....	106
Figure 73 Target amplified audio distribution card .....	107
Figure 74 Left (Audio) MDF Panel .....	108
Figure 75 Amplifiers 2 and 4 are part of this ISMT configuration .....	108
Figure 76 Inserting four jumpers in the right-most position .....	109
Figure 77 ISMT Card (P-ISMT-G) .....	109
Figure 78 Target amplified audio distribution card .....	111
Figure 79 Beacon monitored output module.....	112
Figure 80 P-BK-MON-G with RJ45 J3/J4 Connections.....	113

---

---

Figure 81 P-BK-MON-G with Four Beacon Channels.....	114
Figure 82 Target amplified audio distribution card.....	126
Figure 83 Target amplified relay output board.....	126
Figure 84 Amplifier Chassis.....	129
Figure 85 Defining an Amplifier Chassis.....	130
Figure 86 Passive Terminal Block Card (P-PTBC-G).....	132
Figure 87 PAGASYS GEN II Configurator.....	135

## Tables

Table 1 Controller Models.....	20
Table 2 Environmental and Physical for the Controller Chassis (P-NET-G).....	20
Table 3 Controller Cards.....	21
Table 4 Environmental and Physical for the Controller Backplane (20000170).....	21
Table 5 Environmental and Physical for the Controller Power Supply Cards (P-ADPS-G and P-ADPS-G-01)	22
Table 6 Electrical Specifications for the Power Supply Card (P-ADPS-G).....	23
Table 7 Environmental and Physical for the Controller Processor Card (P-CPC-G).....	24
Table 8 Environmental and Physical for the Amplifier Audio Multiplexer Card (P-AAMC-G).....	26
Table 9 Environmental and Physical for the Internal AP Mux Card (P-IAMC-G).....	27
Table 10 Environmental and Physical for the External AP Mux Card (P-EAMC-G).....	29
Table 11 Environmental and Physical for the Miscellaneous I/O Card (P-CMC-G).....	30
Table 12 Environmental and Physical for the I/O Interface Card (P-IOIC-G).....	31
Table 13 Amplifier Models.....	32
Table 14 Amplifier Chassis Models.....	32
Table 15 Environmental and Physical for the Amplifier.....	33
Table 16 Amplifier Chassis Cards.....	33
Table 17 Power Requirements per Amplifier Card (AC Model).....	34
Table 18 Power Requirements per Amplifier Card (DC Model).....	34

---

Table 19 Environmental and Physical for the Amplifier Signal Backplane (20000154).....	37
Table 20 Environmental and Physical for the Amplifier Power Backplane (20000155).....	38
Table 21 Environmental and Physical for the Amplifier Card (20000150).....	39
Table 22 Environmental and Physical for ISMT Card Specifications (P-ISMT-G).....	41
Table 23 I/O and Terminal Block Models .....	42
Table 24 Termination Points .....	42
Table 25 Environmental and Physical for the Access Panel Aggregator Card (P-APIC-G).....	43
Table 26 Environmental and Physical for the Digital Input Card (P-16DIN-G).....	44
Table 27 Dry Contact Mode for the Digital Input Card (P-16DIN-G) .....	44
Table 28 24 V PLC Contact Mode for the Digital Input Card (P-16DIN-G).....	45
Table 29 Environmental and Physical for the Beacon Monitored Module (P-BK-MON-G) .....	46
Table 30 Environmental and Physical for the Relay Output Card (P-SPDT-G) .....	47
Table 31 Environmental and Physical for the Fan Control and Monitoring Card (P-FCMC-G) .....	49
Table 32 Temperature Measurement.....	49
Table 33 Fan Power Supply .....	49
Table 34 Monitored Input Circuits.....	50
Table 35 Environmental and Physical for the Monitored Input Module (P-MONIC-G) .....	51
Table 36 Passive Terminal Block Card Models.....	51
Table 37 Environmental and Physical for the Passive Terminal Block Card (P-PTBC-G) .....	52
Table 38 Environmental and Physical for the Cable Power Injector I/O Card (P-CPIC-G).....	53
Table 39 Amplifier Audio Distribution Cards .....	53
Table 40 Environmental and Physical for the Amplifier Audio Distribution Terminal Block Cards (P-AAD-Cx-G).....	55
Table 41 Environmental and Physical for the Fan Wiring Termination Card (P-FWTC-G).....	56
Table 42 TB2 Connector Signals (P-AP-IS-BARRIER-G).....	57
Table 43 TB3 Connector Signals (P-AP-IS-BARRIER-G).....	57
Table 44 J1 Connector Signals (P-AP-IS-BARRIER-G) .....	57

---

---

Table 45 J2 Connector Signals (P-AP-IS-BARRIER-G) .....	58
Table 46 Environmental and Physical for the IS Barrier Board (P-IS-BARRIER-G).....	58
Table 47 Environmental and Physical for the High Integrity Card (P-NPLUS1-G) .....	59
Table 48 Access Panel and Microphone Station Models .....	60
Table 49 Relay output board terminal block pinout for speaker muting.....	127
Table 50 PAGASYS GEN II Controller Service Parts .....	138
Table 51 PAGASYS GEN II Amplifier Service Parts .....	138
Table 52 PAGASYS GEN II I/O and Terminal Block Service Parts.....	138

## 1.0 Safety Messages

**⚠ WARNING**

This equipment should be installed, adjusted, and serviced by qualified technicians familiar with the construction and operation of the equipment and the hazards involved.

Read, understand, and follow all of the warnings provided in the Safety Messages section of this instruction manual before servicing the system. Failure to do so could result in personal injury, bodily harm, or death to you or others.

### Shock Hazard Warning

Hazardous voltages applied to the Controller Chassis may cause severe injury or death. Verify AC and DC power is disconnected before performing installation or service procedures.



### Static Protection Notice Warning

The printed circuit cards used in this equipment contain static-sensitive components. Observe the warnings listed below to prevent damage to these components. Disregarding any of these warnings may result in personal injury or damage to the equipment.



- Strictly adhere to the procedures provided in this document.
- Before touching any static-sensitive component or printed circuit card containing such a component, discharge all static electricity from yourself by wearing a wrist strap grounded through a 1 megohm resistor.
- Do not touch the traces or components on a printed circuit card containing static-sensitive components. Handle the printed circuit card only by the edges that do not have connector pads.
- After removing a printed circuit card containing a static-sensitive component, place the printed circuit card only on conductive or anti-static material (such as conductive foam, conductive plastic, or aluminum foil). Do not use ordinary Styrofoam or ordinary plastic.

- Store and ship static-sensitive devices or printed circuit cards containing such components only in static shielding containers.
- If it is necessary to repair a printed circuit card containing a static-sensitive component, follow these guidelines:
  - Wear an appropriately grounded wrist strap.
  - Work on a conductive surface.
  - Use a grounded soldering iron.
  - Use grounded test equipment.

## **1.1 Hazard Classification**

Federal Signal uses signal words to identify the following:

### **⚠ DANGER**

DANGER indicates a hazardous situation which, if not avoided, will result in death or serious injury.

### **⚠ WARNING**

WARNING indicates a hazardous situation which, if not avoided, could result in death or serious injury.

### **⚠ CAUTION**

CAUTION indicates a hazardous situation which, if not avoided, could result in minor or moderate injury.

### **NOTICE**

NOTICE is used to address practices not related to physical injury.

***Read and understand the information contained in this manual before attempting to deploy or service the system.***

## 2.0 General Description

### 2.1 Introduction

This document describes the features, installation, operation, and maintenance of the PAGASYS GEN II Public Address and General Alarm System. The PAGASYS GEN II system provides robust public address and general alarm services for use in various environments, including, but not limited to, offshore petrochemical facilities, onshore petrochemical facilities, and onshore industrial facilities.

### 2.2 Overview

The public-address functions include broadcasting live-voice announcements from one or more microphones across all or selected areas of the facility. The general alarm functions include broadcasting pre-recorded alarm tones or voice messages across all or selected areas of the facility. These general alarm functions respond to alarm conditions initiated manually or by third-party automatic equipment (such as fire and gas detection, process monitoring, or other safety monitoring systems). The system also supports non-emergency, pre-recorded messages for routine operational events. The above functions are supplemented by visual indication through beacons, status lamps, and so forth, as required.

System robustness is maintained through redundant system architectures, comprehensive fault monitoring functions, and automatic re-routing of audio signals and control signals to bypass failed components.

PAGASYS GEN II is a rack-mounted, software-controlled system that can incorporate duplicate control systems and redundant/protected audio signaling.

### 2.3 System Architecture

PAGASYS GEN II consists of one or more central equipment cabinets.

These cabinets contain:

- **Control Subsystem:** Manages and monitors the components of the system.
- **Power Amplifiers:** Generate amplified electrical audio signals to speaker line level (typically 100 V or 70 V) and have a typical continuous power output of several hundred watts.
- **Audio Subsystem:** Contains audio routing and mixing, alarm tone generation, audio message stores, and other related audio processing.
- **I/O Subsystem:** Interfaces to field and third-party equipment.

A standard PC is often installed in the central equipment cabinet for configuration, test, and fault reporting. It is not required for the normal operation of the system.



The system has field equipment, including:

- **Loudspeakers:** Convert the electrical audio signal from the amplifiers into a corresponding sound.
- **Beacons and Status Lamps:** Supplement audio broadcasts in areas of high ambient noise with visual signaling.
- **Access Panels and Microphone Stations:** Include microphones and button controls.

Redundancy is one of the techniques employed to ensure the robustness of a system, allowing it to perform its functions in the event of component or subsystem failure.

Redundancy relies on three features:

- The provision of duplicated subsystems, components, and interconnections
- The ability to detect the failure of the above
- The ability to re-route control and audio signals in response to such a failure

The PAGASYS GEN II system provides three types of system redundancy:

- Single standalone system, where a single controller supports its own set of amplifiers and I/O cards with no redundancy.
- High Integrity (Master + Standby), where a pair of controllers share a single set of amplifiers and I/O cards, offering control redundancy.
- Duplicated Pair, commonly known as an A/B pair, where each controller supports a separate set of amplifiers and I/O cards, offering control, amplifier, and I/O redundancy.

Figure 1 PAGASYS GEN II A/B Pair Architecture

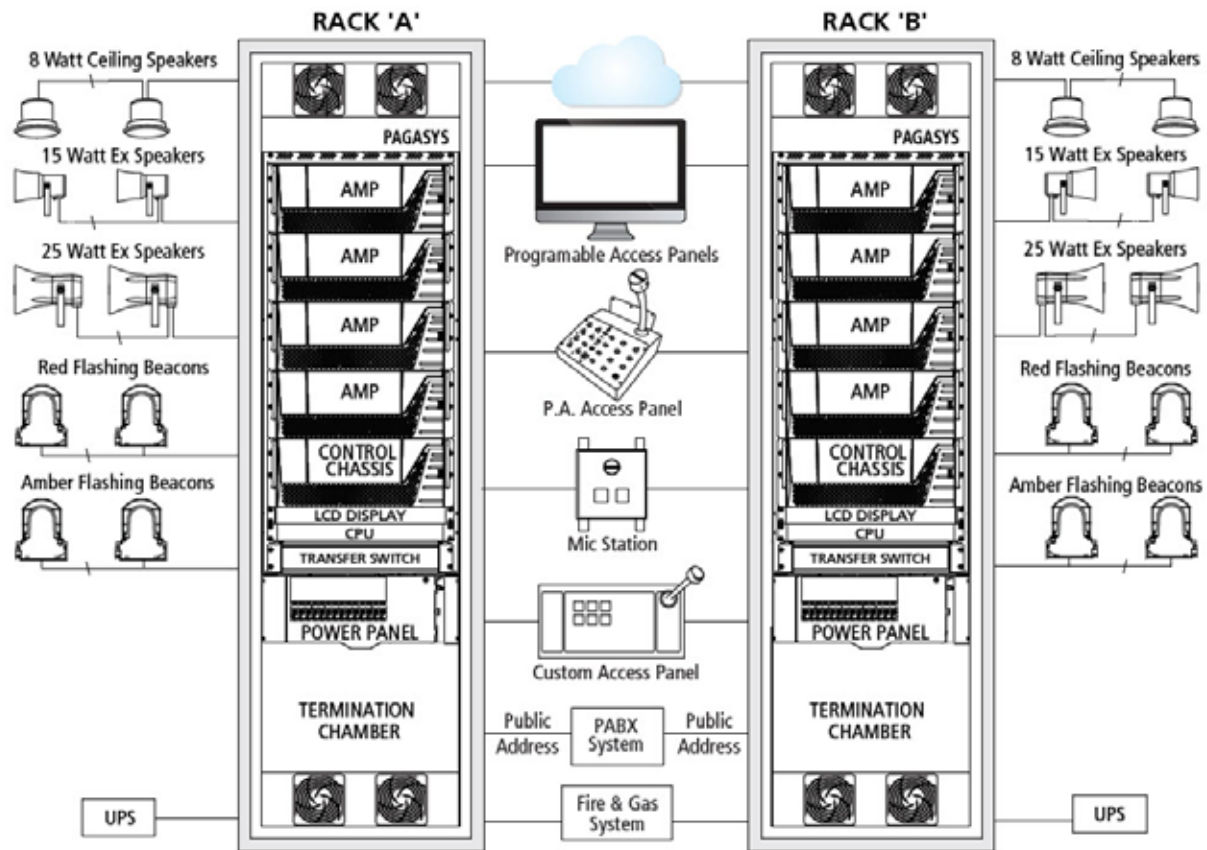

## 2.4 Features

The PAGASYS GEN II system has the following features:

- System Manager application provides real-time system status, including event logs, system activity, broadcast status, impedance speaker monitoring, fan flow, and amplifier temperature status
- A single Controller can support up to thirty-two 1200 W Amplifier Chassis
- Supports multi-voice audio, driving up to 6 voices concurrently up to 128 zones
- DSP-based Audio
- Up to 32 access panels per system
- Supports Intelligent Speaker Monitoring and Tapping (ISMT)
- Non-ISMT speaker number is limited only by the total power of the amplifier
- Up to 32 speakers per loop (with ISMT)
- Audio “ducking” for clear voice communication over a sounding alarm
- Up to 128 zones
- Up to 32 external audio inputs

- Up to 128 recorded messages
- Seven broadcast categories with unlimited priority levels
- Front cabinet access for ease of maintenance
- Web-based GUI interface for ease in configuration and monitoring
- Programmable logging of calls and fault events, for example:
  - Access Panels
  - Amplifier standby routing
  - PABX interface
- DNV Type Approved and CE Certified as a Public Address and General Alarm System, using the standards DNVGL-CG-0339, the relevant parts of IEC60945 Ed. 4 for protected equipment, and EN 61000-3-2:2006, EN 61000-3-3:1995, EN 55103-2:2009

## 2.5 Components

### 2.5.1 PAGASYS GEN II Kits

Federal Signal provides kits for PAGASYS GEN II equipment and can provide the end user with the knowledge to complete the system build using their own design or using Federal Signal PA/GA design solution. This kit solution provides significant cost savings for Federal Signal customers while ensuring that they receive Federal Signal quality PA/GA life-safety critical systems. For more information on PAGASYS GEN II kits, see “20.1 Ordering Standard Cabinets and Accessories” on page 135.

**Figure 2 PAGASYS GEN II Kit Solutions**

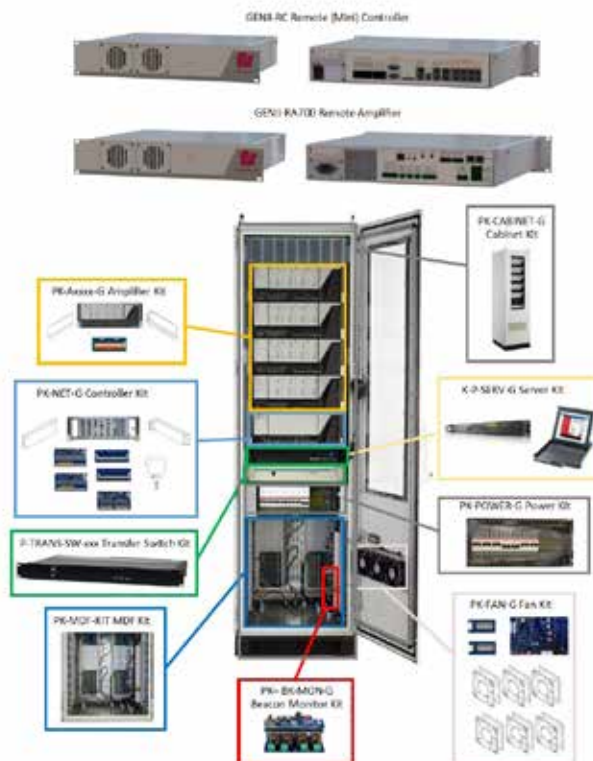

## General Description

### 2.5.2 Controller Chassis

The Controller Chassis includes the Controller Backplane and the Controller daughter cards. (See Figure 3.) The Controller Backplane provides the electrical power and signal interconnections between the various controller daughter cards or modules to form a complete Controller. Table 1 lists the Controller Chassis and Backplane models.

**Figure 3 Controller Chassis (P-NET-G)**

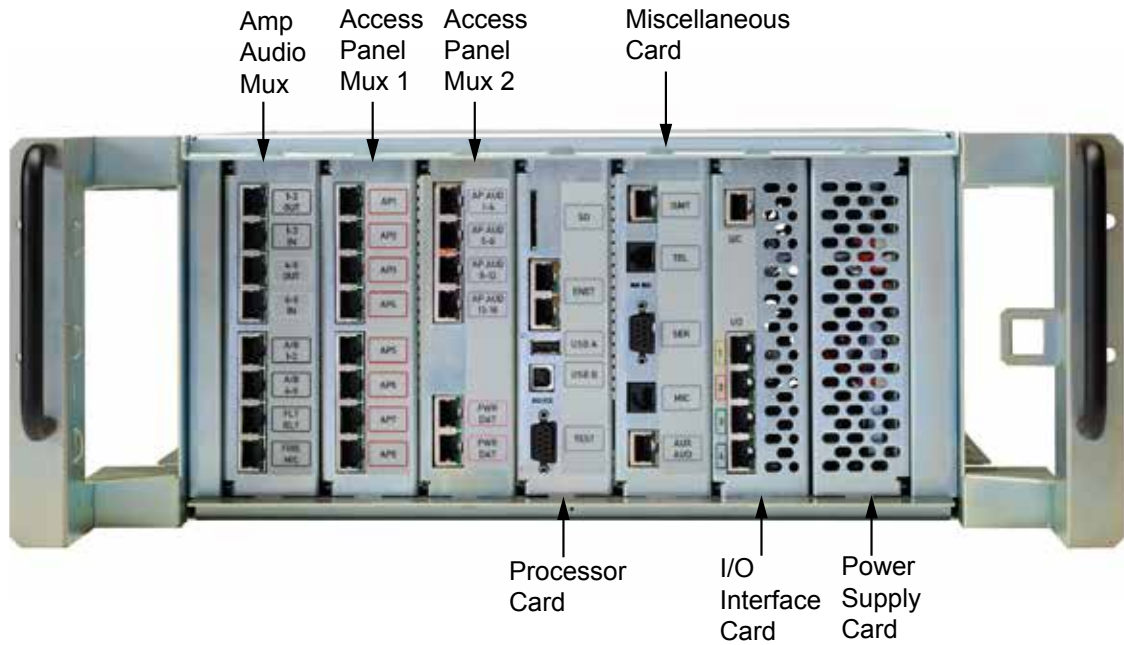

**Table 1 Controller Models**

Model	Description
P-NET-G	Controller Chassis
K20000170	Controller Backplane Service Model

**Table 2 Environmental and Physical for the Controller Chassis (P-NET-G)**

Operating Temperature	-10 to +55°C
Humidity	0-98% non-condensing
Controller Chassis Dimensions (H x W x L)	197 mm x 356 mm x 375 mm
Weight	10.6 kg/23.44 lb

### 2.5.3 System Controller Backplane (20000170)

The System Controller Backplane (20000170) provides the electrical power and signal interconnections between the various controller cards to form a complete System Controller. (See Figure 4.)

**NOTE:** The service model for the System Controller Backplane is K20000170.

**Figure 4 System Controller Backplane (20000170)**

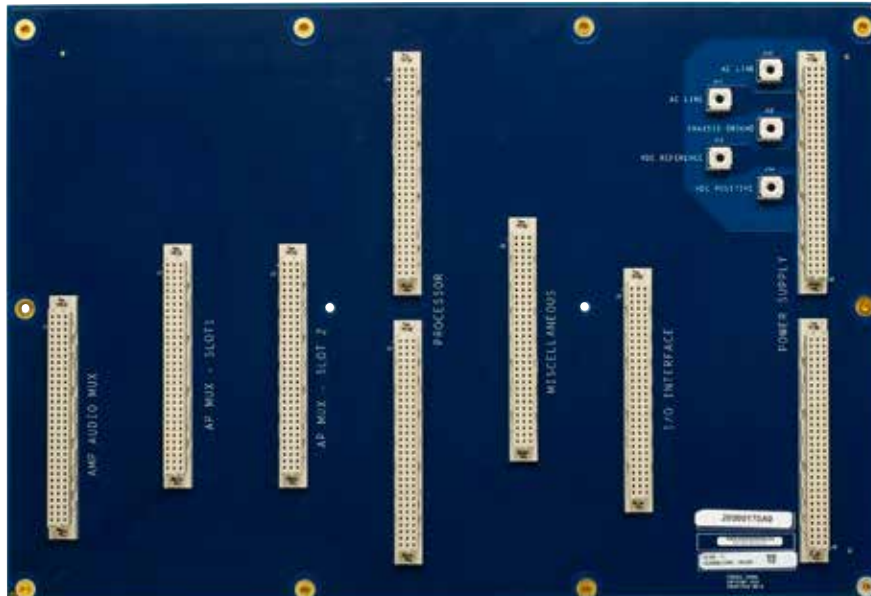

Table 3 lists the PAGASYS GEN II controller cards that can be inserted into the backplane.

**Table 3 Controller Cards**

Model	Description	Backplane Slot
P-ADPS-G	Power Supply Card (120/240 VAC)	Power supply
P-CPC-G	Controller Card (DSP/ARM)	Processor
P-AAMC-G	Amplifier Audio Mux Card	Amp Audio I/O Mux
P-IAMC-G	Internal AP Mux Card	AP Mux slot 1 or 2
P-EAMC-G	External AP Mux Card	AP Mux slot 1 or 2
P-CMC-G	Miscellaneous Card	Miscellaneous
P-IOIC-G	I/O Interface Card	I/O interface

### 2.5.4 Controller Backplane Specifications

**Table 4 Environmental and Physical for the Controller Backplane (20000170)**

Operating Temperature	-10 to +55°C
Humidity	0-98% non-condensing
Controller Backplane Dimensions (H x W x L)	177 mm x 483 mm x 476 mm
Weight	0.57 kg/1.25 lb

## General Description

### 2.5.5 Power Supply Card (120/240 Vac) (P-ADPS-G)

The Power Supply card is the primary power supply for the AC-powered Controller Chassis. (See Figure 5.) This card supports universal 90 to 264 Vac voltage input, with onboard AC fusing.

The Controller Power Supply card addresses the System Controller Chassis's various DC power needs. The card provides 24 Vdc, 12 Vdc, 5 Vdc, and 3.3 Vdc power on separate power rails.

This card also provides control and monitoring of the chassis's temperature. The Power Supply card stores the following: card information, including card serial number, part number, and date of manufacture.

**NOTE:** The service model for the System Controller Power Supply card is K-P-ADPS-G.

**Figure 5 Power Supply Card (120/240 Vac)(P-ADPS-G)**

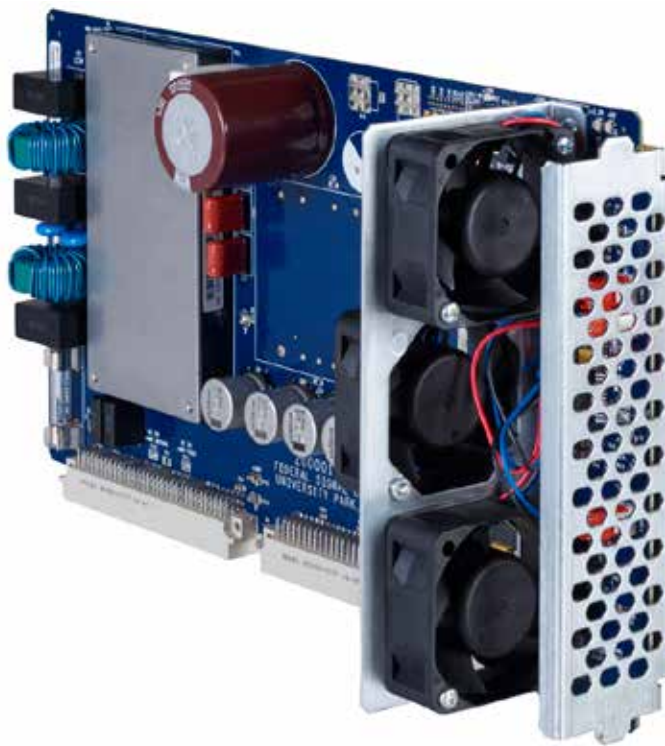

**Table 5 Environmental and Physical for the Controller Power Supply Cards (P-ADPS-G and P-ADPS-G-01)**

Operating Temperature	-10 to +55°C
Humidity	0-98% non-condensing
P-ADPS-G Dimensions (H x W x L)	45 mm x 343 mm x 171.9 mm
Weight	0.83 kg/1.83 lb

**Table 6 Electrical Specifications for the Power Supply Card (P-ADPS-G)**

AC supply input voltage range		85–264 V <sub>RMS</sub>
AC supply input Frequency		50/60 Hz
Max Input Current Draw		
115 V input		3.2 A
230 V input		1.6 A
<b>DC power supply rail</b>	<b>Parameter</b>	<b>Output Voltage / Current</b>
24 Vdc rail	Output voltage range Max Output current	23.7 V–24.9 V
12 Vdc rail	Output voltage range Max Output current	11.7 V–12.3 V
5 Vdc rail	Output voltage range Max Output current	4.9 V–5.2 V
3.3 Vdc rail	Output voltage range Max Output current	3.3 V–3.4 V

### 2.5.6 Controller Processor Card (DSP/ARM) (P-CPC-G)

The Controller Processor card (P-CPC-G) uses an Advanced RISC Machine (ARM) processor and a Field-Programmable Gate Array (FPGA) based Universal Asynchronous Receiver/Transmitters (UARTs) to serve as a hub for all data communication and to coordinate the main control functions required by the PAGASYS GEN II system. (See Figure 6.) The Controller Processor card also contains a Digital Signal Processor (DSP) to carry out all digital audio processing.

In addition to the UART communication interfaces, the Controller Processor card also includes a network switch, a SATA interface for an on-board hard disk (for primary and backup data storage), and an SD card interface.

The Controller Processor card also provides an interface for an optional Digital Audio Network Through Ethernet (Dante) module to provide up to 16 channels of bidirectional digital streaming over an Internet Protocol (IP) network.

For external communications, the Controller Processor card contains several communications interfaces, including an Inter-Integrated Circuit (I<sup>2</sup>C) bus, USB Master/Slave interfaces, and an RS232 port.

The card includes a battery holder for a 3 V Lithium CR16xx coin battery cell, which supports the processor card real-time clock when power is removed from the Controller Chassis. The processor card is shipped with the battery inserted in the battery holder, but the battery is not operational until the Mylar insert is removed from the battery. See the Controller Chassis Operations section of this document for the procedure to remove and replace the battery.

## General Description

---

The Controller Processor card uses a watchdog circuit to monitor processor operation and reset the processor if the watchdog timer is not updated.

**NOTE:** The service model for the System Controller Processor card is K-P-CPC-G.

**Figure 6 Controller Card (DSP/ARM) (P-CPC-G)**



**Table 7 Environmental and Physical for the Controller Processor Card (P-CPC-G)**

Operating Temperature	-10 to +55°C
Humidity	0-98% non-condensing
P-CPC-G Dimensions (H x W x L)	45 mm x 343 mm x 171.9 mm
Weight	0.42 kg/0.92 lb



### **2.5.7 Amplifier Audio Mux Card (P-AAMC-G)**

The Amplifier Audio Multiplexer card (P-AAMC-G) provides an interface to connect a System Controller to its associated Amplifiers. (See Figure 7.) In addition, the P-AAMC-G provides the interface needed to connect two System Controllers to form N+1 redundant PAGASYS GEN II system.

The P-AAMC-G provides eight buffered Analog to Digital Converter (ADC) channels to digitize incoming analog input audio for subsequent DSP audio processing. The eight audio inputs include six audio inputs received through the A/B connection from another System Controller, one audio input from the local microphone preamplifier located on the Miscellaneous (P-CMC-G) card, and one audio input from the Private Automatic Branch Exchange (PABX) interface on the Miscellaneous card.

The P-AAMC-G provides an audio Digital-to-Analog Converter (DAC), which provides 14 buffered analog output channels that are routed to the following circuits:

- Six Audio inputs of local Amplifier Chassis
- Six Audio inputs of another System Controller through the A/B connection
- Controller Chassis audio auxiliary output
- Controller Chassis audio PABX interface

The System Controller A/B connection supported by this card includes a full-duplex RS485 interface and six bidirectional analog audio paths. When the local System Controller is in a failure state, the P-AAMC-G enters a Fallback state that enables audio signals connected to the local audio amplifiers to be supplied by a second System Controller through the A/B connection.

The P-AAMC-G also includes the fireman's interface for the System Controller. During normal operation, the fireman's microphone audio is routed to the Access Panel Mux card in slot 1, where it can be digitized (P-IAMC-G or P-EAMC-G). When the P-AAMC-G card is in a Fallback state, and the fireman's microphone PTT signal is active, the audio signals connected to all the local audio amplifiers are supplied from the fireman's microphone rather than the second System Controller.

**NOTE:** The service model for the Amplifier Audio Mux card is K-P-AAMC-G.

Figure 7 Amplifier Audio Mux Card (P-AAMC-G)



Table 8 Environmental and Physical for the Amplifier Audio Multiplexer Card (P-AAMC-G)

Operating Temperature	-10 to +55°C
Humidity	0-98% non-condensing
P-AAMC-G Dimensions (H x W x L)	45 mm x 343.9 mm x 152.25 mm
Weight	0.41 kg/0.90 lb

### 2.5.8 Internal AP Mux Card (P-IAMC-G)

The Internal Access Panel Multiplexer card (P-IAMC-G) provides the interface to connect eight Access Panels or Microphone Stations to a System Controller. (See Figure 8.) Install the P-IAMC-G card in the System Controller Chassis in AP MUX slots 1 or 2, or in both slots. See the External Access Panel Multiplexer card (P-EAMC-G) for another option for these two System Controller AP MUX slots.

Access Panels connected to the P-IAMC-G are numbered differently depending on the installation of the P-IAMC-G. If installed into AP MUX slot 1, Access Panels are numbered from 1 to 8. If installed into AP MUX slot 2, the Access Panels are numbered from 17 to 24.

The P-IAMC-G communicates with remote Access Panels or Microphone Stations through eight electrically isolated full-duplex RS422 serial ports. When Access Panels need to communicate with the P-IAMC-G card using field wiring, use the Passive Terminal Block card (P-PTBC-G) to convert the field wiring to a compatible RJ45 cable that can connect directly to the P-IAMC-G card.

When remote Access Panels are located in a hazardous area, use Zener safety barriers mounted on an IS Barrier card (P-IS-BARRIER-G) between the P-IAMC-G and the field wiring to provide a safe interface. You can connect two Access Panels or Microphone Stations to each IS BARRIER card.

**NOTE:** The service model for the Internal Access Panel Multiplexer card is K-P-IAMC-G.

**Figure 8 Internal AP Mux Card (P-IAMC-G)**



**Table 9 Environmental and Physical for the Internal AP Mux Card (P-IAMC-G)**

Operating Temperature	-10 to +55°C
Humidity	0-98% non-condensing
P-IAMC-G Dimensions (H x W x L)	45 mm x 343.9 mm x 171.9 mm
Weight	0.44 kg/0.97 lb

### 2.5.9 External AP Mux Card (P-EAMC-G)

The External Access Panel Multiplexer card (P-EAMC-G), when combined with two Access Panel Aggregator cards (P-APIC-G), can provide the interface to connect up to 16 Access Panels or Microphone Stations to a System Controller. (See Figure 9.) Install the P-EAMC-G card in the System Controller Chassis in AP MUX slots 1 or 2, or in both slots. See the Internal Access Panel Multiplexer card (P-IAMC-G) for another option for these two System Controller AP MUX slots.

Access Panels connected to the P-EAMC-G are numbered differently depending on the installation of the P-EAMC-G. If installed into AP MUX slot 1, Access Panels are numbered from 1 to 16. If installed into AP MUX slot 2, the Access Panels are numbered from 17 to 32.

Each P-APIC-G that interfaces with the P-EAMC-G card provide up to eight electrically isolated RS422 full-duplex serial ports for connection to remote Access Panel or Microphone Stations. The System Controller communicates with the microcontrollers located on up to two P-APIC-G cards through a half-duplex RS485 serial port located on the front panel of the P-EAMC-G card.

Each P-EAMC-G provides 16 buffered ADC channels for digitizing 16 audio signals produced by up to 16 remote Access Panels or Microphone Stations.

**NOTE:** The service model for the External Access Panel Multiplexer card is K-P-EAMC-G.

**Figure 9 External AP Mux Card (P-EAMC-G)**



**Table 10 Environmental and Physical for the External AP Mux Card (P-EAMC-G)**

Operating Temperature	-10 to +55°C
Humidity	0-98% non-condensing
P-EAMC-G Dimensions (H x W x L)	45 mm x 343.9 mm x 171.9 mm
Weight	0.51 kg/1.13 lb

### 2.5.10 Miscellaneous I/O Card (P-CMC-G)

The Miscellaneous I/O card (P-CMC-G) (see Figure 10) provides several input/output (I/O) interfaces for the System Controller:

- Local Microphone
- PABX Interface Module
- Auxiliary audio interface
- ISMT RS485 Port
- RS232 command-line interface for processor card DSP

The Miscellaneous I/O card provides an audio preamp for the PAGASYS GEN II local microphone. The preamplifier also provides a 20-kHz test tone, which is injected into the microphone capsule to enable critical signal path monitoring between the microphone capsule and processor card DSP. A press-to-talk (PTT) interface circuit is provided to enable monitoring of the microphone PTT button.

The P-CMC-G provides a PABX interface module for the System Controller. The PABX interface module plugs into the P-CMC-G board. Configure the PABX interface with the System Manager software to operate with a standard analog extension line or a CO trunk line. The PABX interface provides ring, call progress tone and DTMF tone detection. The incoming and outgoing telephone audio signals are routed from the PABX interface circuit located on P-CMC-G, through the System Control backplane, and onto the Amplifier Audio MUX card, where the audio signals are converted to and from a digital format, respectively. The System Processor card controls and monitors the interface through a serial port connected to the microcontroller located on the P-CMC-G.

Similarly, the P-CMC-G provides an auxiliary audio interface for the System Controller. The incoming and outgoing auxiliary audio signals are routed through the P-CMC-G AUX Audio connector, through audio transformers located on the P-CMC-G, through the System Controller Backplane, and onto the P-AAMC-G and the AP Mux card slot in System Controller slot 1, where the signals are converted to and from a digital format respectively. A press-to-talk (PTT) interface input circuit is provided to enable monitoring of the Auxiliary audio input external PTT switch contact. A PTT interface output circuit is provided to enable remote monitoring of the Auxiliary audio output relay contact.

**NOTE:** The service model for the Miscellaneous I/O card is K-P-CMC-G.

Figure 10 Miscellaneous I/O Card (P-CMC-G)



Table 11 Environmental and Physical for the Miscellaneous I/O Card (P-CMC-G)

Operating Temperature	-10 to +55°C
Humidity	0-98% non-condensing
P-CMC-G Dimensions (H x W x L)	45 mm x 343.9 mm x 171.9 mm
Weight	0.38 kg/0.84 lb

### 2.5.11 I/O Interface Card (P-IOIC-G)

The I/O Interface card (P-IOIC-G) provides I/O interfaces for the System Controller. (See Figure 11.)

The P-IOIC-G card provides four electrically isolated half-duplex RS485 serial port interfaces for communication with the I/O modules used in the system and a 24 Vdc supply to power these I/O modules.

The P-IOIC-G card also provides one electrically isolated I<sup>2</sup>C bus for communication with legacy PAGASYS I/O modules and a 24 Vdc supply to power the I/O modules.

**NOTE:** The service model for the I/O Interface card is K-P-IOIC-G.

Figure 11 I/O Interface Card (P-IOIC-G)



Table 12 Environmental and Physical for the I/O Interface Card (P-IOIC-G)

Operating Temperature	-10 to +55°C
Humidity	0-98% non-condensing
P-IOIC-G Dimensions (H x W x L)	45 mm x 343.9 mm x 171.9 mm
Weight	0.29 kg/0.63 lb

### 2.5.12 Amplifier Chassis

The Amplifier Chassis is an industrial grade, high-efficiency Class D amplifier designed for Public Address and General Alarm applications. (See Figure 12.) It can deliver full power at temperatures from -10 to +55°C.

The Amplifier Chassis contains up to four 300 W amplifier cards that share two common motherboards. (See Figure 13.) The front motherboard is a signal router board, while the rear motherboard is a power connection board. An optional Intelligent Monitoring and Tapping (ISMT) card may be inserted into the chassis on the right side of the signal router motherboard.

## General Description

The Amplifier Chassis's daughter cards, modules, and backplanes are listed in Table 14.

**Table 13 Amplifier Models**

Model	Description
20000154	Amplifier Signal Backplane
20000155	Amplifier Power Backplane
20000150	300 W Amplifier Card
P-ISMT-G	ISMT Line Card (Optional)

The Amplifier Chassis models are listed in the following table.

**Table 14 Amplifier Chassis Models**

Model	Description
P-A250-G	Amplifier Chassis with backplane cards, one 100 V amplifier PCB
P-A500-G	Amplifier Chassis with backplane cards, two 100 V amplifier PCBs
P-A750-G	Amplifier Chassis with backplane cards, three 100 V amplifier PCBs
P-A1000-G	Amplifier Chassis with backplane cards, four 100 V amplifier PCBs
P-A250-G-70	Amplifier Chassis with backplane cards, one 70 V amplifier PCB with transformers, no ISMT
P-A500-G-70	Amplifier Chassis with backplane cards, two 70 V amplifier PCBs with transformers, no ISMT
P-A750-G-70	Amplifier Chassis with backplane cards, three 70 V amplifier PCBs with transformers, no ISMT
P-A1000-G-70	Amplifier Chassis with backplane cards, four 70 V amplifier PCBs with transformers, no ISMT
P-ISMT-G	ISMT line card

**Figure 12 Amplifier Chassis**

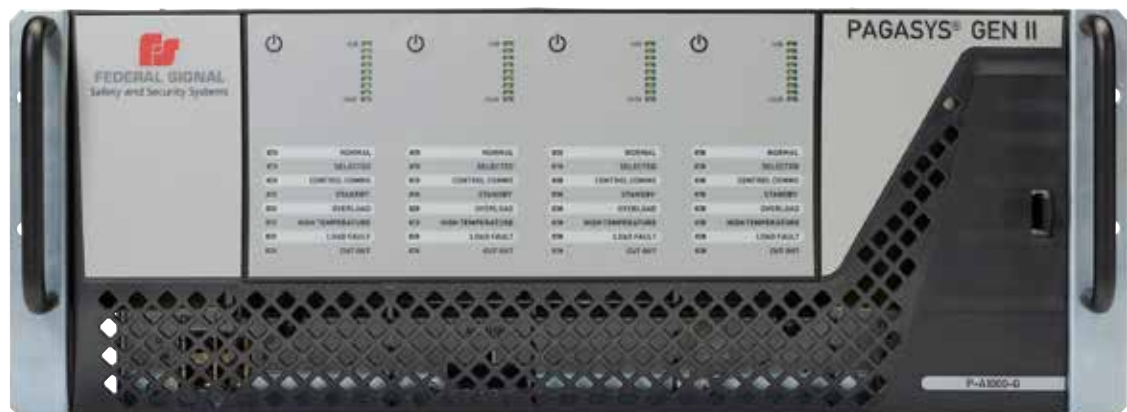
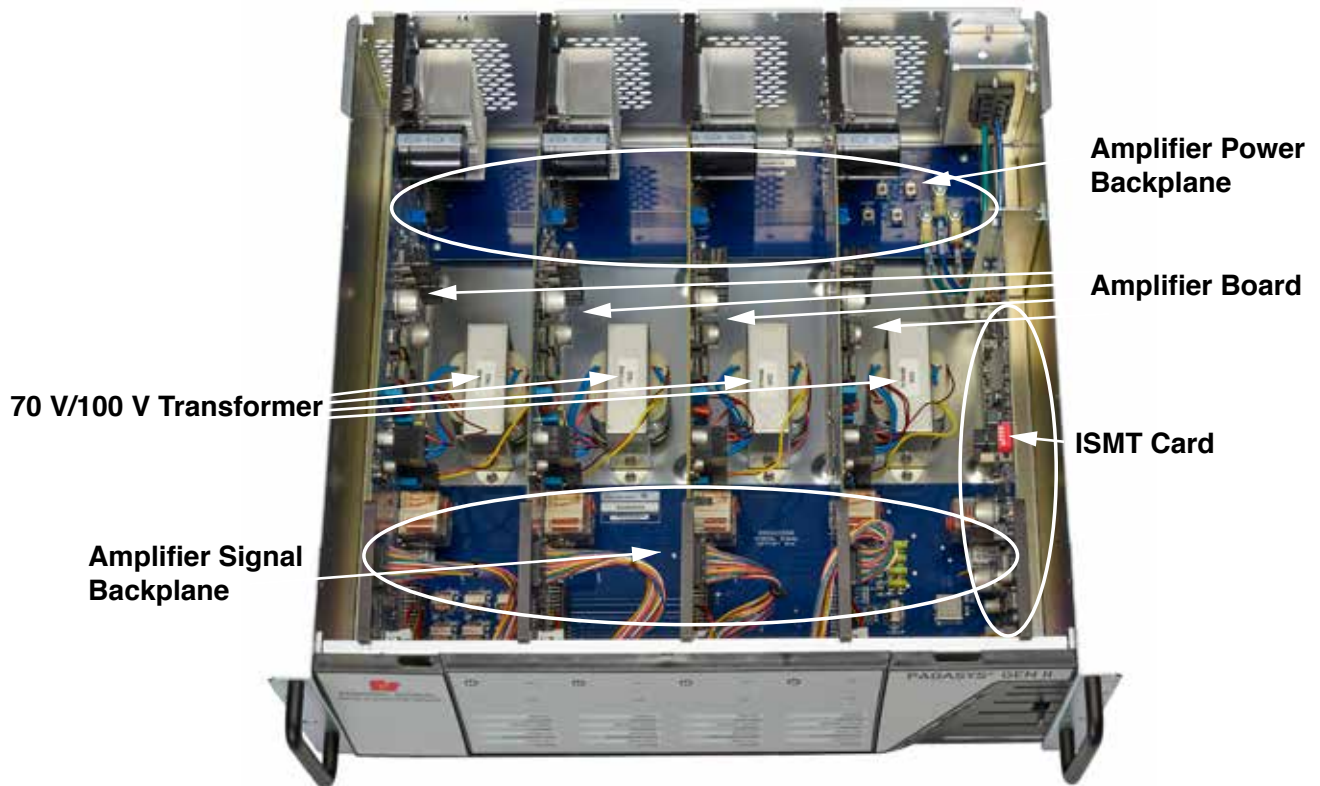



Figure 13 Amplifier Chassis Card Layout (P-A1000-G)



### 2.5.13 Amplifier Specifications

Table 15 Environmental and Physical for the Amplifier

Operating Temperature	-10 to +55°C
Humidity	0–98% non-condensing
Amplifier Chassis Dimensions (H x W x L)	177 mm x 483 mm x 478 mm
Weight	13.9 kg (Not including cards)

Table 16 Amplifier Chassis Cards

Model	Weight
P-A250-G	11.4 kg/25.15 lb
P-A500-G	13.2 kg/29.20 lb
P-A750-G	15.1 kg/33.25 lb
P-A1000-G	16.9 kg/37.30 lb
P-A250-G-70	11.4 kg/25.15 lb
P-A500-G-70	13.2 kg/29.20 lb
P-A750-G-70	15.1 kg/33.25 lb
P-A1000-G-70	16.9 kg/37.30 lb
P-ISMT-G	0.24 kg/0.53 lb

**Table 17 Power Requirements per Amplifier Card (AC Model)**

Universal AC Power Line Input	90–264 Vac, 50/60 Hz
Power Consumption at 230 Vac, 300 W output	350 W
Efficiency at 230 Vac	85.6%
Power Consumption at 120 Vac, 300 W output	355 W
Efficiency at 120 Vac	84.6%
Idle Power (15 V test tone) at 120/230 Vac	12 W
Standby Power at 120/230 Vac	7 W
Sleep Power (Software enabled)	2.8 W

**Table 18 Power Requirements per Amplifier Card (DC Model)**

48 Vdc Supply Input	40–56 Vdc
Power Consumption at 48 Vdc, 300 W output	325 W
Idle Power (15 V test tone)	7.5 W
Standby Power at 120/230 Vac	4 W
Sleep Power (Software enabled)	1.3 W
Efficiency at 48 Vdc	92.25%

## 2.6 Amplifier Front Panel

The Amplifier Front Panel contains four sets of power buttons and status LEDs, one for each amplifier module. (See Figure 14.) They have the following functions.

Fields	Description
Power Button	Turns off power to its amplifier module when pressed and held for three seconds. Another press for half a second restores the power.
Normal	Indicates current status of the Amplifier card in the respective slot. Status indications include the following: <ul style="list-style-type: none"> <li>Steady Green indicates that the module is working and all the parameters of the latest test are normal.</li> <li>Blinking indicates that the module has power, but one or more parameters are out of the normal range, although the audio output is still present at a reduced or distorted level.</li> <li>Steady Off, while one or more other lights are on, indicates that the module has power but is not capable of producing an output audio signal at this time.</li> </ul>
Selected	Steady Blue indicates that the audio power output relay is activated, and the 100 V audio output is connected to the output header.
Control Comms	Blinking Blue indicates that the module is communicating with the Controller.
Stand By	Steady Yellow indicates that the speakers connected to this Amplifier card have been rerouted to a standby audio output cable, receiving audio output power from a Standby Amplifier module.
Overload	Yellow indicates that current in the output stage of the module is temporarily in a higher than normal level, and the current limiter is being brought into use.

Fields	Description
High Temperature	Yellow indicates that the temperature of the internal temperature sensor has exceeded 80°C. The module may stop operation if the temperature continues to rise and reaches a cut-out temperature level.
Load Fault	Yellow indicates that the latest self-diagnostic test indicated the output speaker impedance is out of its calibration range or that the Earth fault was detected.
Cut Out	Yellow indicates that the module is in a short term cut out mode due to abnormal operating conditions. It tries to return to normal operation after 2 seconds. This cut-out mode also takes place during the initial power-up sequence of the amplifier.
0 dB to -24 dB LED	Green indicates the level of the voltage being delivered into the load/speaker system in 3 dB intervals.

Figure 14 Amplifier Front Panel



### 2.6.1 Amplifier Front Chassis

The Amplifier Front Chassis is visible when the front cover of the Amplifier Chassis is removed. (See Figure 15.) The front chassis contains the connections needed for control communications with the System Controller to provide amplification and output of input audio signals and to support Standby Amplifier operations.

The Amplifier Front Chassis has four RJ45 ports that support the input/output of low-level audio and bidirectional RS485 control communications. The input ports are the two lower ports, and the output ports are the two top ports.

The Amplifier Chassis provides amplified audio through the Amplified Audio Out interface. More information on the pin-out for this cable is provided in the PAGASYS GEN II P-A1000-G Technical Information Guide.

Standby Amplifier operation with other Amplifier Chassis in the PAGASYS GEN II system is supported through the Standby Amplifier Bus interfaces on the Amplifier Front Chassis. All chassis that are part of a Standby Amplifier group must be interconnected through these interfaces. The left port is the input for the Standby Amplifier Bus interface; the right port is the output.

Each Amplifier position has a cooling fan that is controlled by the Amplifier in the chassis slot. See PAGASYS GEN II System Manager User Manual for more information on amplifier fan cooling operation.

Figure 15 Amplifier Front Chassis

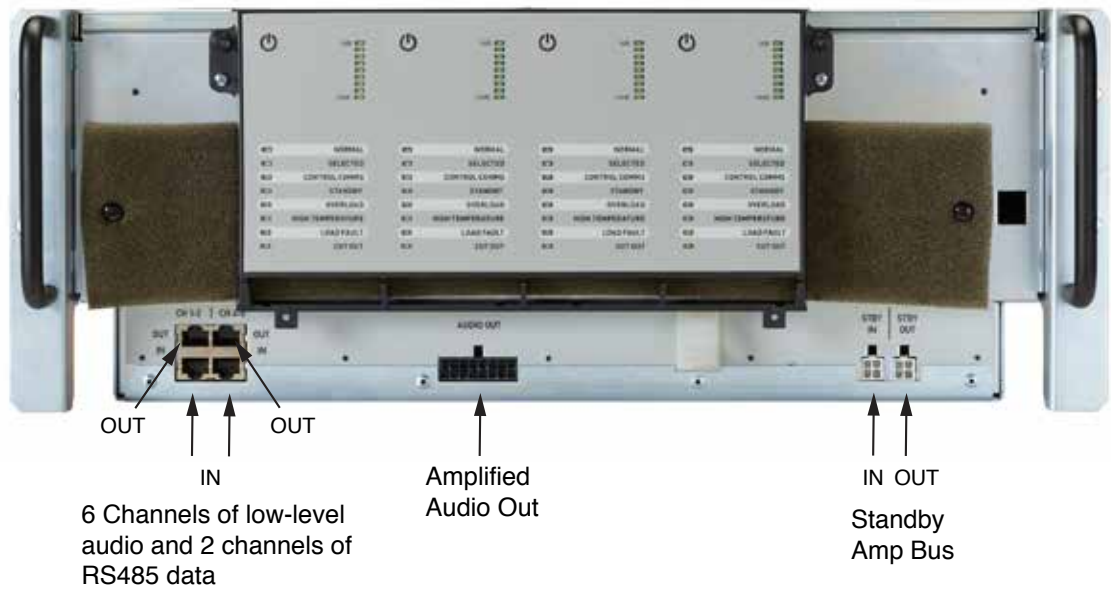

### 2.6.2 Amplifier Signal Backplane (20000154)

The Amplifier Signal Backplane (20000154) provides control interfaces for the Amplifier Chassis. (See Figure 16.)

The Amplifier Signal Backplane is located at the front bottom of the Amplifier Chassis. It has four sets of white and black headers labeled SLOT 1 to SLOT 4 that serve as connections for the four amplifier cards. The white 16-pin headers are for audio power outputs, while the 24-pin black headers are for audio inputs and communications. A fifth white header on the right side is for an optional ISMT module card. The connections on the bottom are visible on the front of the chassis and are described with the Amplifier Chassis.

**NOTE:** The service model for the Amplifier Signal Backplane is K20000154.

Figure 16 Amplifier Signal Backplane (20000154)

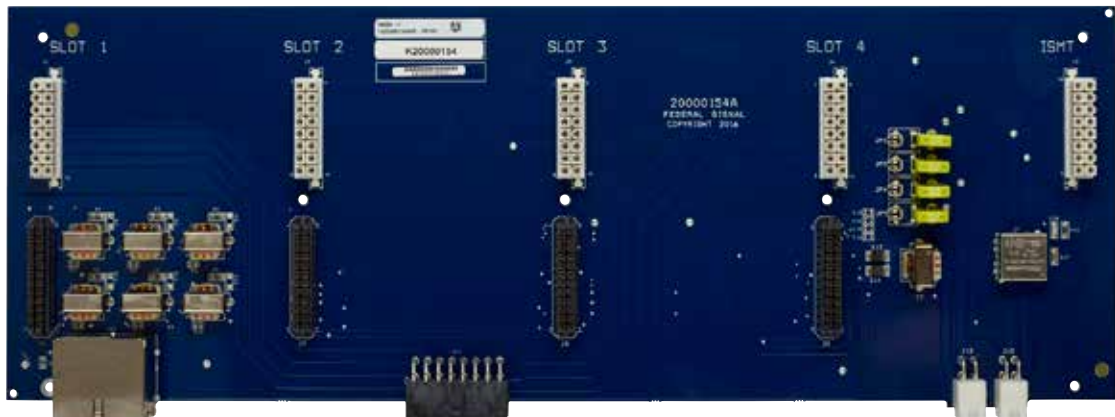

**Table 19 Environmental and Physical for the Amplifier Signal Backplane (20000154)**

Operating Temperature	-10 to +55°C
Humidity	0-98% non-condensing
20000154 Dimensions (H x W x L)	30 mm x 389 mm x 138 mm
Weight	0.26 kg/0.58 lb

### 2.6.3 Amplifier Power Backplane (20000155)

The Amplifier Power Backplane (20000155) provides power interfaces for the Amplifier Chassis. (See Figure 17.).

The Amplifier Power Backplane is located at the rear bottom of the Amplifier Chassis.

It has three power lugs for connecting AC power:

- AC LINE
- AC NEUTRAL
- CHASSIS GND

It has four power lugs for connecting DC power:

- +48 V A
- +48 V B
- GND BAT A
- GND BAT B

AC and DC power options are mutually exclusive (cannot be used at the same time).

The Amplifier Power Backplane has four 24-pin headers labeled SLOT 1 to SLOT 4, which are connections for the four amplifier cards. The Amplifier Power Backplane has a red module with five microswitches in the upper left corner that serves for configuring the Amplifier Chassis address/identification number.

**NOTE:** The service model for the Amplifier Power Backplane is K20000155.

**Figure 17 Amplifier Power Backplane (20000155)**

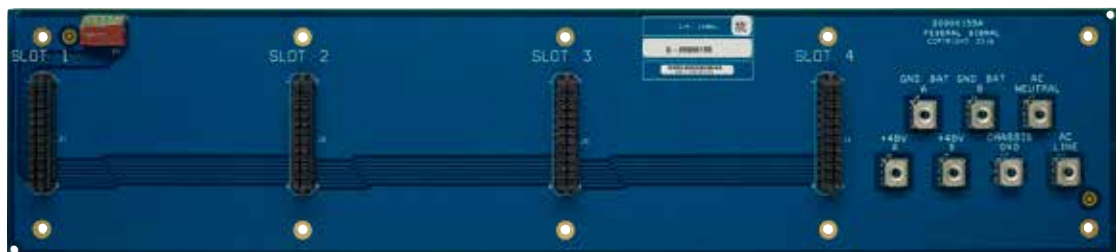

**Table 20 Environmental and Physical for the Amplifier Power Backplane (20000155)**

Operating Temperature	-10 to +55°C
Humidity	0-98% non-condensing
20000155 Dimensions (H x W x L)	18 mm x 389 mm x 87 mm
Weight	0.19 kg/0.42 lb

#### **2.6.4 Amplifier Card (20000150)**

The Amplifier Card (20000150), shown in “Figure 18 Amplifier Card (20000150)” on page 39, provides 70 V or 100 V audio signaling output at a max power level of 300 W. Up to four Amplifier Cards may be installed in an Amplifier Chassis.

The Amplifier Cards have vertical positioning and plug into connector headers in both the Amplifier Signal and Amplifier Power Backplanes. The SLOT number 1 to 4 on the motherboards determines the amplifier number in the chassis.

You can designate an Amplifier Card as a Standby Amplifier. Install the Standby Amplifier in physical slot 4 of an Amplifier Chassis. The Standby Amplifier can support standby operations at the chassis level (up to three other Amplifiers in the current chassis) or support additional Amplifiers in a PAGASYS GEN II system (up to 127 amplifiers). To support amplifiers outside of the Standby Amplifier Chassis, the amplifiers must share an audio path, and all chassis in the Standby group must have interconnected Standby Bus connections. Many configurations of Standby groups are possible. These are determined by the interconnections between the Standby Bus and the system configuration.

The 100 V version of the Amplifier Card requires a 100 W output transformer, model K12000775. The 70 V version of the Amplifier Card is similar to the 100 V Amplifier Card but has a different model number, 20000150-70, and requires a 70 W output transformer, model K12001655.

**NOTE:** The service models for the Amplifier Cards are K20000150 (100 V) and K20000150-70 (70 V). The service models for the output transformers are K12000775 (100 V) and K12001655 (70 V).

The picture below shows the 100 V Amplifier Card 20000150.

**Figure 18 Amplifier Card (20000150)**

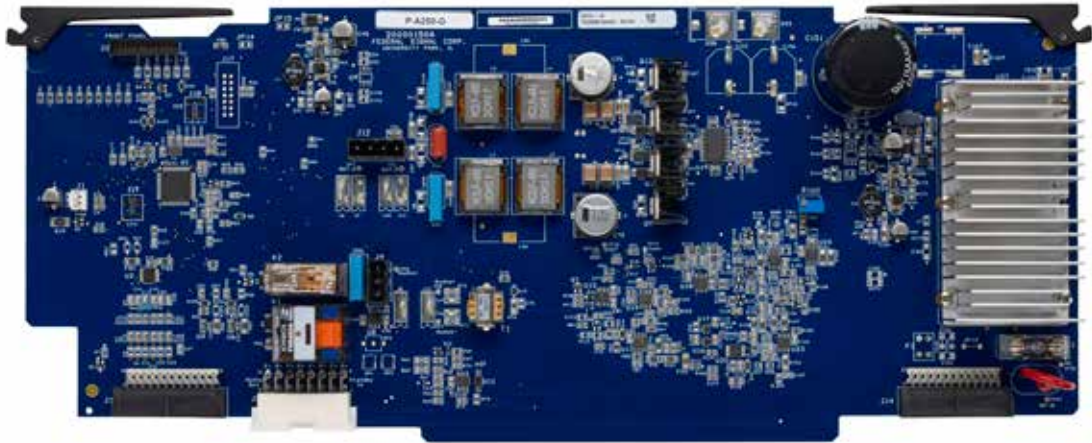

**Table 21 Environmental and Physical for the Amplifier Card (20000150)**

Operating Temperature	-10 to +55°C
Humidity	0-98% non-condensing
20000150 Dimensions (H x W x L)	65 mm x 410 mm x 169 mm
Weight	0.75 kg/1.65 lb

### 2.6.5 ISMT Card (P-ISMT-G)

The ISMT card (P-ISMT-G) provides Intelligent Speaker Monitoring and Tapping functionality for the Amplifier Chassis when used with ISMT capable speakers. (See Figure 19.) The ISMT card uses special communication commands sent over the speaker lines to communicate with the ISMT capable speakers. Using this communication link, each ISMT loudspeaker can be instructed to change its transformer tapping, recalibrate itself, and return status information back to the ISMT card.

The ISMT card, when needed, is inserted into the Amplifier Signal Backplane in the fifth white connector on the right side of the card. (See Figure 20.)

One ISMT card can monitor the speaker circuits connected to all four Amplifier cards in the local Amplifier Chassis and the speaker circuits connected to other Amplifier cards in other chassis when they are connected via the standby bus cable. See “5.3.10 Installing the ISMT Card (Optional)” on page 73.

**NOTE:** The service model for the ISMT card is K-P-ISMT-G.

### Configuring for non-ISMT

To configure a group of Amplifier Chassis sharing a common Standby Amplifier Bus for non-ISMT Amplifier Standby routing:

- You may configure only one Amplifier Chassis in the Amplifier group to contain a Standby Amplifier.
- In the chassis containing the Standby Amplifier, fit the four jumpers on the front motherboard on the left side. (See Figure 20.)
- Completely remove or move the four jumpers on the front motherboard of every other chassis in the group to the right side in all chassis other than the chassis with the Standby Amplifier.

### Configuring for ISMT

To configure a group of Amplifier Chassis sharing a common Standby Amplifier Bus for ISMT Amplifier Standby routing:

- You may configure only one Amplifier Chassis in the group to contain a Standby Amplifier.
- In the chassis containing the Standby Amplifier, only one ISMT card may be installed in the group of chassis.
- Completely remove or move the four jumpers on the front motherboard of every chassis in the group to the right side in all chassis.
- When inserting an ISMT card into a chassis, the ISMT card red module with five micro switches must be configured to match the address of the host Amplifier Chassis.

**Figure 19 ISMT Card (P-ISMT-G)**

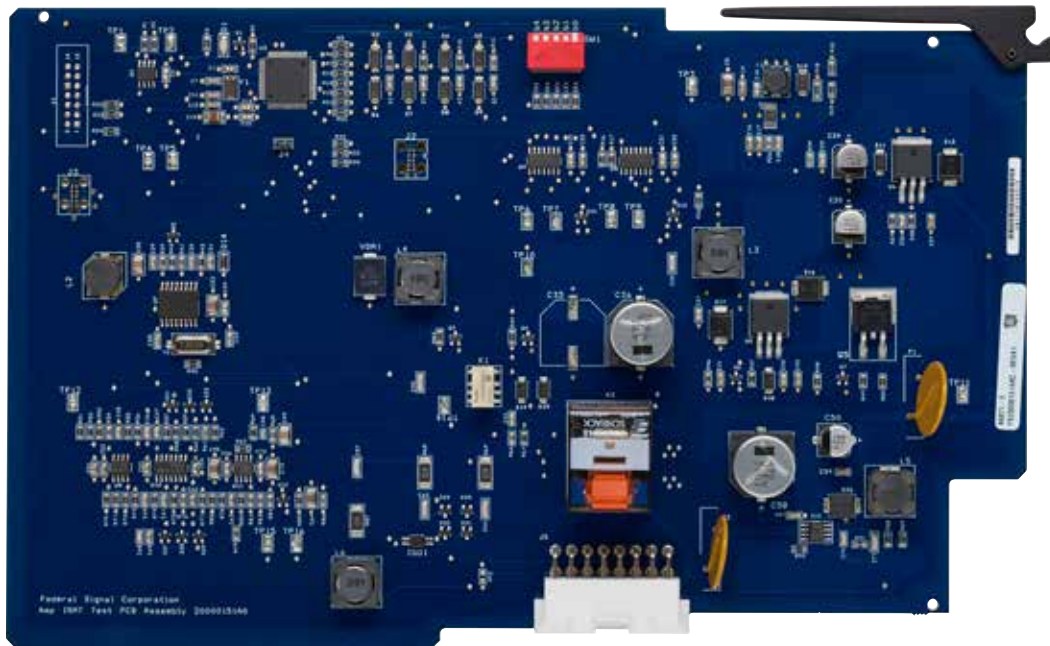
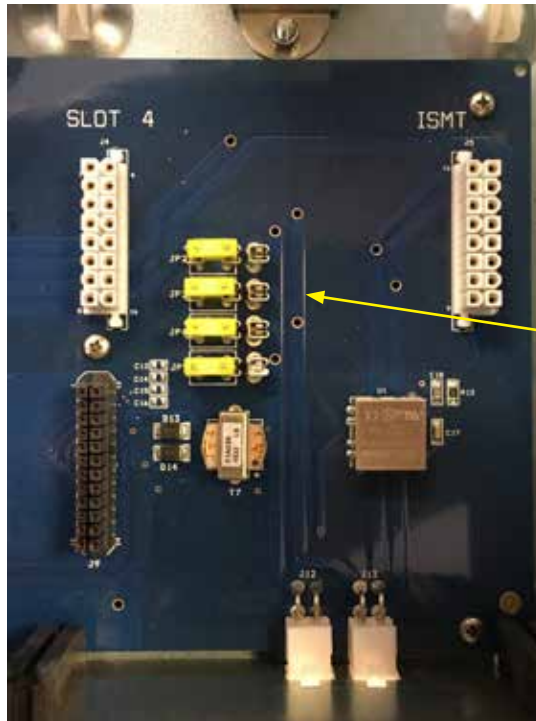



Figure 20 ISMT Connector on the Amplifier Signal Backplane



ISMT  
connector

If the amplifier in slot 4 is to be the Standby Amplifier, fit the four jumpers on the left side.

**NOTICE:** If an ISMT card is installed in the ISMT slot, remove the jumpers from the board to avoid damaging the ISMT board.

Table 22 Environmental and Physical for ISMT Card Specifications (P-ISMT-G)

Operating Temperature	-10 to +55°C
Humidity	0-98% non-condensing
P-ISMT-G Dimensions (H x W x L)	20.4 mm x 269 mm x 169 mm
Weight	0.24 kg/0.53 lb

### 3.0 I/O and Terminal Block Cards

The I/O and Terminal Block cards for wire terminations are mounted in an easy-access front entry area at the bottom of the cabinet. (See Table 23.)

**Table 23 I/O and Terminal Block Models**

Model	Description	Card Type	Location	Included with Standard Model or Optional
P-APIC-G	Access Panel Aggregator I/O Card GEN II	I/O Card	Rear I/O Panel	Optional
P-16DIN-G	Digital Input I/O Card GEN II	I/O Card	Rear I/O Panel	Standard
P-BK-MON-G	Beacon Monitoring I/O GEN II	I/O Card	Power I/O Panel	Standard
P-SPDT-G	Relay Output I/O Card GEN II	I/O Card	Rear I/O Panel	Standard
P-FCMC-G	Fan Control and Monitoring I/O Card GEN II	I/O Card	Top I/O Panel	Standard
P-MONIC-G	Monitored Input I/O Card GEN II	I/O Card	Rear I/O Panel	Optional
P-PTBC-G	Passive Terminal Block Card	Terminal Block	Rear I/O Panel	Standard
P-CPIC-G	Cable Power Injector I/O Card	Terminal Block	Power I/O Panel	Optional
P-AADC1-G	Amplifier Audio Distribution Card 1:1	Terminal Block	Audio I/O Panel	Optional
P-AADC2-G	Amplifier Audio Distribution Card 1:2	Terminal Block	Audio I/O Panel	Standard
P-AADC4-G	Amplifier Audio Distribution Card 1:4	Terminal Block	Audio I/O Panel	Optional
P-AADC8-G	Amplifier Audio Distribution Card 1:8	Terminal Block	Audio I/O Panel	Optional
P-FWTC-G	Fan Wiring Termination Card	Terminal Block	Door/Roof	Standard
P-IS-BARRIER-G	IS Barrier Board	Terminal Block	Rear I/O Panel	Optional

#### 3.1 Access Panel Aggregator I/O Cards (P-APIC-G)

The Access Panel Aggregator I/O card, available in three models, is one of several I/O boards designed specifically for integration into the PAGASYS GEN II system. (See Figure 21.) These I/O boards use a standard control interface, which greatly simplifies the internal wiring of the cabinets.

The Access Panel Aggregator I/O card provides termination points for Access Panels. See the list of models with attributes below.

**Table 24 Termination Points**

Model	Number of Access panels supported	AP Field Connection Type
P-APIC-G	4	Cage clamp terminal block
P-APIC-G-01	4	Screw terminal block
P-APIC-G-02	8	RJ45

The P-APIC-G is a microcontroller-based card assembly that acts as a communication hub with its connected Access Panel, continually gathering and collating the status of each Access Panel keypad button and conveying the required state of each Access Panel keypad LED to the Access Panel’s onboard microcontroller.

The System Controller receives the collated Access Panel keypad button status data from P-APIC-G(s) and defines the required state of each Access Panel LED to the P-APIC-G card.

How the PAGASYS GEN II system reacts to an Access Panel button press is solely controlled by the PAGASYS GEN II System Controller and is dependent on the overall system configuration and priorities.

**NOTE:** The service model for the standard Access Panel Aggregator I/O card is K-P-APIC-G.

**Figure 21 Access Panel Aggregator I/O Card, RJ45 Connector (P-APIC-G)**

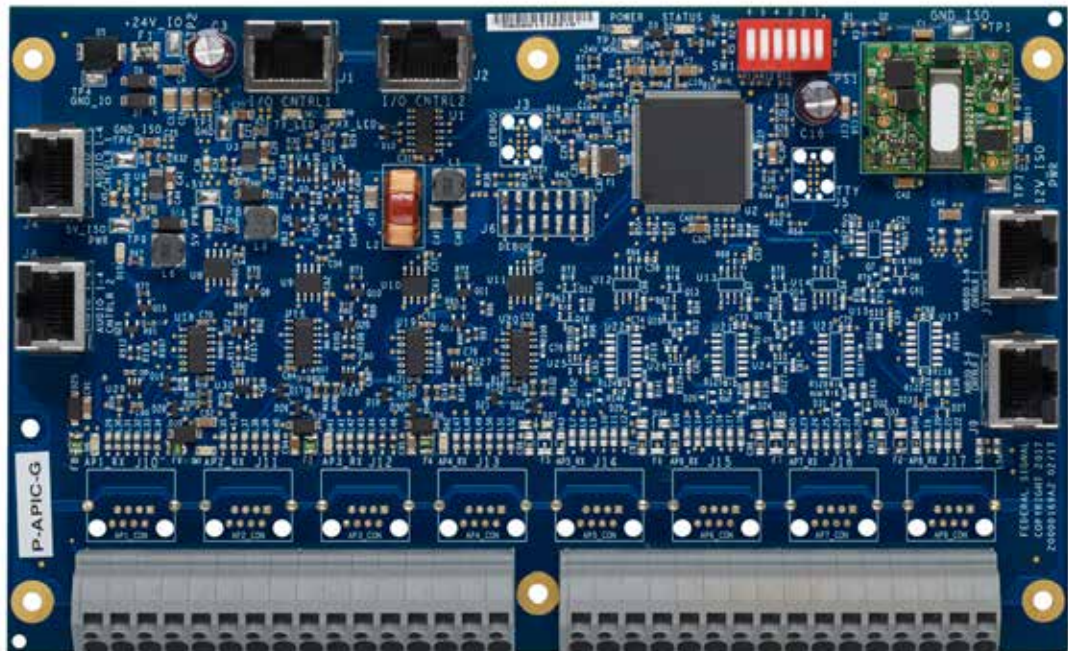

LED Reg	Port 1 4052	Port 2 4058	Port 3 405E	Port 4 4064	Port 5 406A	Port 6 4070	Port 7 4076	Port 8 407C
---------	----------------	----------------	----------------	----------------	----------------	----------------	----------------	----------------

**Table 25 Environmental and Physical for the Access Panel Aggregator Card (P-APIC-G)**

Operating Temperature	-25 to +55°C
Humidity	0-98% non-condensing
P-APIC-G Dimensions (H x W x L)	30 mm x 200 mm x 122 mm
Weight	0.18 kg/0.40 lb

### 3.2 Digital Input I/O Card (P-16DIN-G)

The Digital Input card (P-16DIN-G) is one of several I/O boards designed specifically for integration into the PAGASYS GEN II system. (See Figure 22.) These I/O boards use a standard control interface that greatly simplifies the internal wiring of the cabinets.

The Digital Input card provides 16 individual digital inputs that you can individually configure to support dry contact mode or 24 V PLC mode. The card also provides status LEDs for each input that, when illuminated, indicate when the input is activated. The inputs are monitored by the Controller.

**Figure 22 Digital Input I/O Card (P-16DIN-G)**

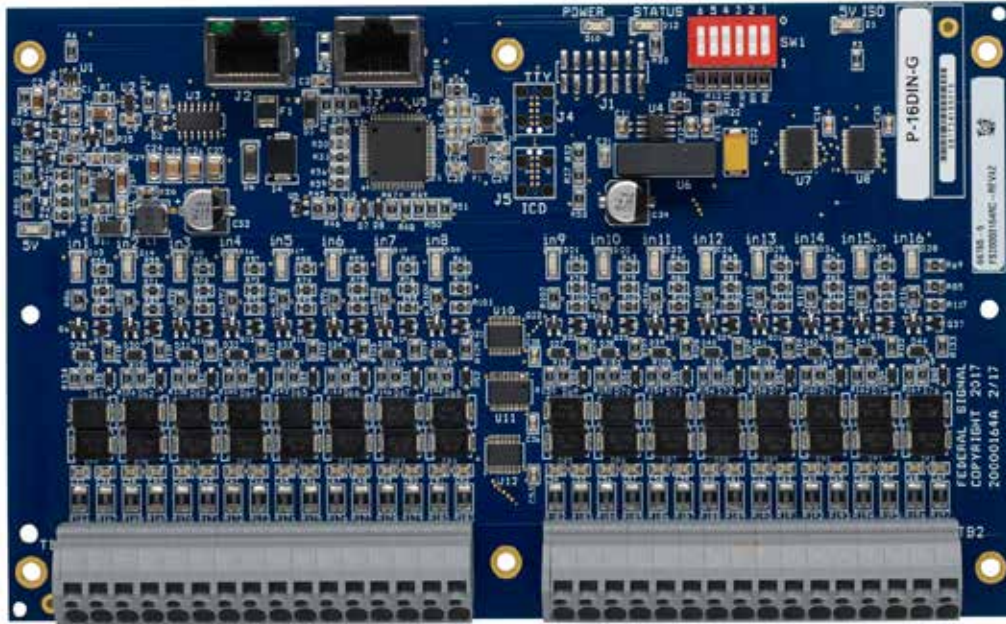

In dry contact mode, the input senses a short between the plus and minus pins to activate the input; an open circuit between the plus and minus pins deactivates the input.

In 24 V PLC input mode, the input senses 24 V applied across the plus and minus pins to activate the input. Removal of the applied 24 V deactivates the input.

**NOTE:** The service model for the Digital Input I/O card is K-P-16DIN-G.

#### 3.2.1 Digital Input Card Specifications (P-16DIN-G)

**Table 26 Environmental and Physical for the Digital Input Card (P-16DIN-G)**

Operating Temperature	-25 to +55°C
Humidity	0-98% non-condensing
Amplifier Chassis Dimensions (H x W x L)	23 mm x 200 mm x 122 mm
Weight	0.18 kg/0.40 lb

**Table 27 Dry Contact Mode for the Digital Input Card (P-16DIN-G)**

Maximum Output Voltage – Open Circuit	5.5 V
Maximum Output Current – Short Circuit	5 mA

**Table 28 24 V PLC Contact Mode for the Digital Input Card (P-16DIN-G)**

Maximum Input Voltage	30 V
Minimum Input Voltage to Activate	5 V
Input Current – 24 V Applied	5 mA

### 3.3 Beacon Monitored Output Module (P-BK-MON-G)

The Beacon Monitored Output module (P-BK-MON-G) is one of several I/O modules designed specifically for integration into the PAGASYS GEN II system. (See Figure 23.) These I/O modules use a standard control interface that greatly simplifies the internal wiring of the cabinets.

The Beacon Monitored Output module provides two independent beacon control and monitoring channels. Each beacon control and monitoring channel can operate in two modes:

- Beacon circuit energized mode: The beacon's electrical supply is applied to the beacon circuit, causing the beacons to operate.
- Beacon circuit cable monitoring mode: The beacon monitoring and control interface circuit checks the integrity of the beacon circuit cable. This requires an End of Line Resistor (ELR) at the end of each radial beacon circuit.

Typically, beacon circuits are arranged in a loop or radial configuration, or sometimes in a combination of both. Up to nine radial circuits, each terminated with an ELR, can be successfully monitored by each beacon monitoring and control channel.

**NOTE:** The service model for the Beacon Monitored Output module is K-P-BK-MON-G.

**Figure 23 Beacon Monitored Output Module (P-BK-MON-G)**



**3.3.1 Beacon Monitored Module Specifications (P-BK-MON-G)**

**Table 29 Environmental and Physical for the Beacon Monitored Module (P-BK-MON-G)**

Operating Temperature	-25 to +55°C
Humidity	0-98% non-condensing
P-BK-MON-G Dimensions (H x W x L)	94 mm x 200 mm x 122 mm
Weight	0.91 kg/2.00 lb

**3.4 Relay Output Card (P-SPDT-G)**

The Relay Output card (P-SPDT-G) is one of several I/O boards designed specifically for integration into the PAGASYS GEN II system. (See Figure 24.) These I/O boards use a standard control interface, which greatly simplifies the internal wiring of the cabinets.

The Relay Output card provides 12 single-pole, double-throw (SPDT) voltage-free relay contacts for connection to external equipment or for use within the local cabinet, such as speaker circuit muting.

The Relay Output card provides status LEDs for the following:

- A green Power LED to indicate that the I/O Bus 24 Vdc supply is being applied to the card.
- A green 5 V LED to indicate that on board +5 Vdc switching supply is energized.
- An onboard local microprocessor-controlled status LED to indicate the following.

<b>State</b>	<b>Meaning</b>
Off	Microprocessor failure
On	Microprocessor failure
Pulsed On	Microprocessor is sane and executing code
Pulsed Off	Processor is sane, executing code, and has been addressed by the Controller in the last 30 seconds
Fast Blink	Node identification mode, Response to PcP command visual node identification

- A green status LED for each output relay, which, when illuminated, indicates that the relay coil has been energized.

**NOTE:** The service model for the Relay Output card is K-P-SPDT-G.

Figure 24 Relay Output Card (P-SPDT-G)

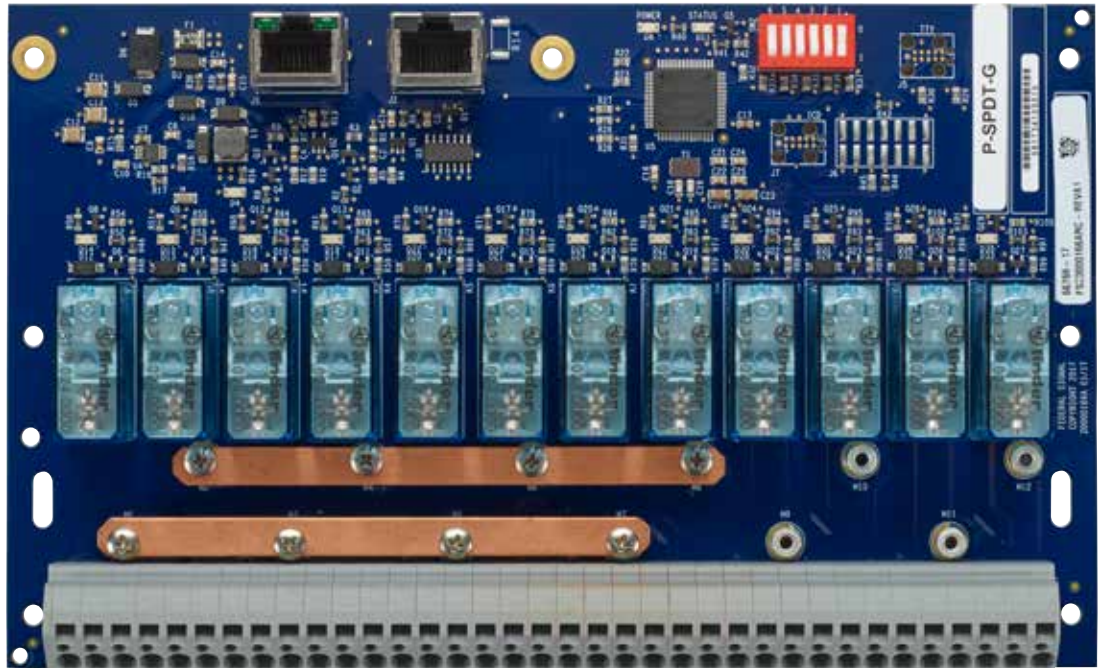

### 3.4.1 Relay Output Card Specifications (P-SPDT-G)

**Table 30 Environmental and Physical for the Relay Output Card (P-SPDT-G)**

Operating Temperature	-25 to +55°C
Humidity	0-98% non-condensing
P-SPDT-G Dimensions (H x W x L)	30 mm x 200 mm x 122 mm
Weight	0.40 kg/0.88 lb

### **3.5 Fan Control and Monitoring Card (P-FCMC-G)**

The Fan Control and Monitoring card is one of several I/O boards designed specifically for integration into the PAGASYS GEN II system. These I/O boards use a standard control interface, which greatly simplifies the internal wiring of the cabinets. (See Figure 25.)

The P-FCMC-G provides the following functions:

- Duplicated wide-input range fan power supply circuits
- External fan DC power supply
- Fan power supply failure detection
- Air temperature measurement
- Automatic fan control based on air temperature
- PAGASYS GEN II Controller remote fan control
- Individual fan failure detection
- Programmable temperature setpoints and hysteresis
- Fail-safe operation

The Fan Control and Monitoring card provides fan control and monitoring for the PAGASYS GEN II system. Two power supply circuits on the card are used to power the cabinet cooling fans. The output from two power supply circuits are combined through diodes to provide a 1+N redundancy scheme, such that a failure in one power supply circuit does not result in loss of fan operation.

The Fan Control and Monitoring card supports autonomous fan control using air temperature measurements from a local temperature sensor mounted on the fan power distribution board. It uses this measured temperature to turn on/off fans based on temperature set points, which are programmable through the fan monitor card configuration page in the PAGASYS GEN II System Manager software. You can override the autonomous fan control on the Fan Monitor diagnostics page in the System Manager software for a period of up to 300 seconds.

The Fan Control and Monitoring card can detect and report individual fan failures. In the event of failure of the Fan Control and Monitoring card, fans are turned on by default.

**NOTE:** The service model for the Fan Control and Monitoring card is K-P-FCMC-G.



Figure 25 Fan Control and Monitoring Card (P-FCMC-G)

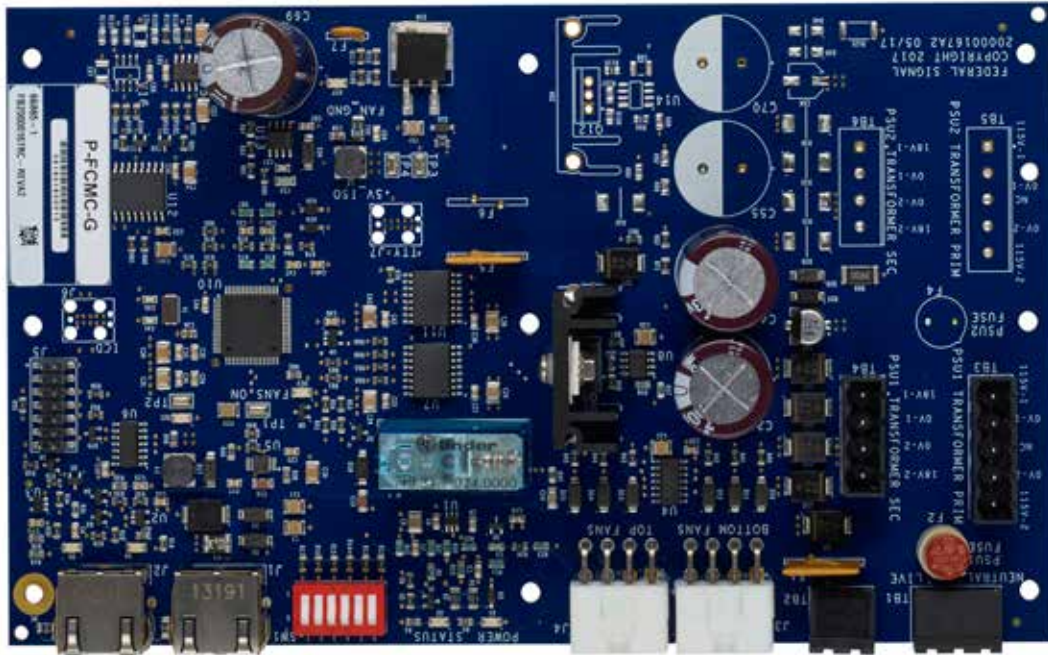

### 3.5.1 Fan Control and Monitoring Card Specifications (P-FCMC-G)

**Table 31 Environmental and Physical for the Fan Control and Monitoring Card (P-FCMC-G)**

Operating Temperature	-25 to +55°C
Humidity	0-98% non-condensing
P-FCMC-G Dimensions (H x W x L)	44 mm x 200 mm x 124 mm
Weight	0.20 kg/0.43 lb

**Table 32 Temperature Measurement**

Measurement range	-30 to +100°C
Measurement Circuit Accuracy	±1°C
Temperature sensor Tolerance at 25°C	±1%

**Table 33 Fan Power Supply**

Fan AC supply input voltage range	85–264 Vac
Input current with 110 V supply	< 600 mA AC
Input current with 230 supply	< 400 mA AC
Fan AC input fuse rating	1.6 A
Fan DC supply output range	24-55 Vdc
Typical Fan current at 48 Vdc	1.2 A
Card Fan fuse hold current	1.85 A
Fan control Relay contacts ratings	10 A

### **3.6 Monitored Input Module (P-MONIC-G)**

The Monitored Input module is one of several I/O modules designed specifically for integration into the PAGASYS GEN II system. (See Figure 26.) These I/O modules use a standard control interface, which greatly simplifies the internal wiring of the cabinets.

The Monitored Input module provides 16 electrically isolated (voltage-free contacts fitted with biasing resistors) monitored inputs for the PAGASYS GEN II system. Typical examples of equipment having voltage-free contacts that require monitoring are an oil platform's fire and gas interface or remote microphone station PTT switch.

The P-MONIC-G provides the following functions:

- 16 independently configurable monitored inputs
- 16 green input status indicator LEDs
- 16 yellow input fault indicator LEDs
- PAGASYS GEN II I/O Bus interface
- 6-bit I/O Bus-address allocating DIP switch
- In-circuit programming
- TTY serial port

**Table 34 Monitored Input Circuits**

Detect closed remote switches	Circuit terminated with 1 K
Detect open remote switches	Circuit terminated with 2 K
Detect circuit fault: open circuit	Circuit resistance > 3.82 K
Detect circuit fault: shorted circuit	Circuit resistance < 470 R

The circuits also provide an alarm status LED and a fault status LED for each monitored input channel. The alarm status LEDs for each input are illuminated when the associated remote switch is closed. The fault status LEDs for each input is illuminated when a fault is detected on its associated external switch circuit.

**NOTE:** The service model for the Monitored Input module is K-P-MONIC-G.

Figure 26 Monitored Input Module (P-MONIC-G)

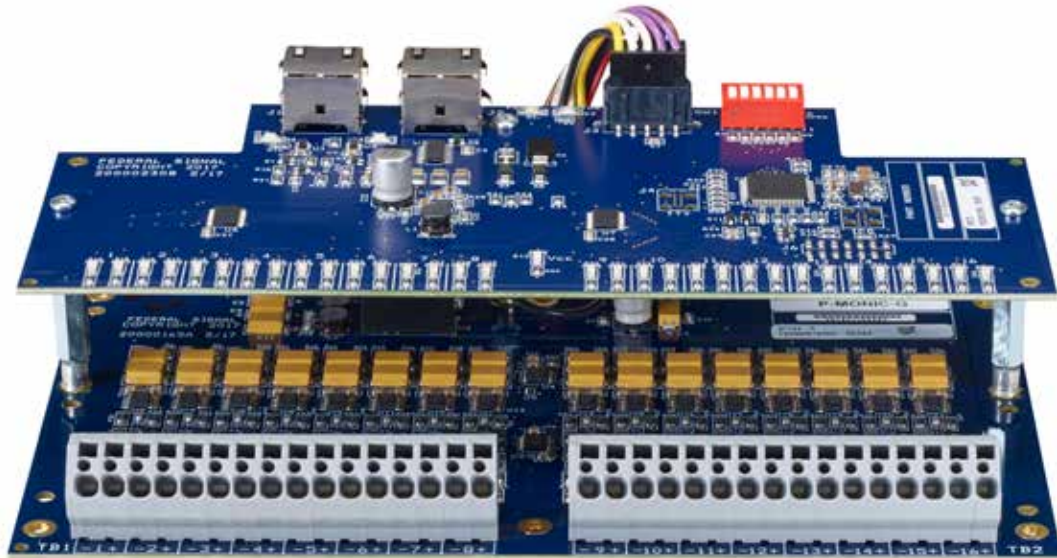

### 3.6.1 Monitored Input Module Specifications (P-MONIC-G)

**Table 35 Environmental and Physical for the Monitored Input Module (P-MONIC-G)**

Operating Temperature	-25 to +55°C
Humidity	0-98% non-condensing
P-MONIC-G Dimensions (H x W x L)	60 mm x 200 mm x 122 mm
Weight (with 2000165 daughter card)	0.17 kg/0.38 lb

### 3.7 Passive Terminal Block Card (P-PTBC-G)

The Passive Terminal Block card (P-PTBC-G) is a passive card that provides four RJ45 to terminal block interfaces. (See Figure 27.) The P-PTBC-G card is primarily intended to provide the cabinet with terminal block type field termination for connection to remote safe area access panels. The PAGASYS GEN II System Controller itself uses RJ45 connectors for its access panel control interfaces. The P-PTBC-G card converts the RJ45 interface to terminal block terminals. Use the P-PTBC-G card wherever there is a requirement to interface between RJ45 cables and terminals blocks.

The Passive Terminal Block card has two models that vary in the type of terminal block contact styles.

**NOTE:** The service model for the Passive Terminal Block card is K-P-PTBC-G.

**Table 36 Passive Terminal Block Card Models**

Model	Number of Access panels supported	Access Panel Field connection Style
P-PTBC-G	4	Cage clamp terminal block
P-PTBC-G-01	4	Screw terminal block

Figure 27 Passive Terminal Block Card (P-PTBC-G)



### 3.7.1 Passive Terminal Block Card Specifications (P-PTBC-G)

Table 37 Environmental and Physical for the Passive Terminal Block Card (P-PTBC-G)

Operating Temperature	-25 to +55°C
Humidity	0-98% non-condensing
P-PTBC-G Dimensions (H x W x L)	30 mm x 200 mm x 79.8 mm
Weight	0.35 kg/0.77 lb

### 3.8 Cable Power Injector I/O Card (P-CPIC-G)

The Cable Power Injector I/O card (P-CPIC-G) is primarily used to boost the number and type of I/O cards that can be connected to an I/O Bus. (See Figure 28.) This is achieved by connecting up to four radial circuits to an I/O Bus, which are powered from an alternative 24 Vdc supply.

Each PAGASYS GEN II System Controller I/O Bus has a practical limit on the number and type of I/O cards that can be powered from the Bus. This practical limit is determined by the current rating of CAT 5/6 cable and the maximum DC current that the PAGASYS GEN II System Controller can provide for each of its four I/O Buses. Given the limits of the system, the current supplied to all the I/O cards connected to a single I/O Bus should not exceed 0.5 A. To increase the number and type of I/O cards that can be connected to an I/O Bus, the Cable Power Injector I/O card can connect up to four radial circuits to an I/O Bus, which are powered from an alternative 24 Vdc supply. The current rating of each of these 4-radial circuits is 1 A.

**NOTE:** The service model for the Cable Power Injector I/O card is K-P-CPIC-G.

Figure 28 Cable Power Injector I/O Card (P-CPIC-G)



### 3.8.1 Cable Power Injector I/O Card Specifications (P-CPIC-G)

**Table 38 Environmental and Physical for the Cable Power Injector I/O Card (P-CPIC-G)**

Operating Temperature	-25 to +55°C
Humidity	0-98% non-condensing
P-CPIC-G Dimensions (H x W x L)	20 mm x 200 mm x 79.8 mm
Weight	0.096 kg/ 0.21 lb

### 3.9 Amplifier Audio Distribution Terminal Block (P-AADCx-G)

The Amplifier Audio Distribution Terminal Block cards (P-AADCx-G) are a range of passive card assemblies that provide terminal block field terminations for the PAGSYS GEN II amplifier's 100 V audio output signals. (See Figures 29-32.)

Amplifier Audio Distribution cards have eight models that vary in the number of amplifiers supported, the number of speaker loop circuits provided per amplifier, and the type of terminal block contact styles.

**Table 39 Amplifier Audio Distribution Cards**

Model	Number of amplifier circuits supported	Speaker loop circuit per amplifier	Terminal block style
P-AADC1-G	8	1	Cage clamp terminal block
P-AADC1-G-01	8	1	Screw terminal block
P-AADC2-G	4	2	Cage clamp terminal block
P-AADC2-G-01	4	2	Screw terminal block
P-AADC4-G	2	4	Cage clamp terminal block
P-AADC4-G-01	2	4	Screw terminal block
P-AADC8-G	1	8	Cage clamp terminal block
P-AADC8-G-01	1	8	Screw terminal block

The PAGSYS GEN II Amplifier Chassis provides a 16-pin audio power connector for its four 100 V audio output signals. Each 100 V audio output signal is provided with four connector pins within this audio power connector enabling the Amplifier Chassis to monitor the integrity of the connected external speaker closed-loop circuit.

The P-AADCx-G cards are connected to the Amplifier Chassis audio power connectors through amplifier audio out cable assemblies. There are several versions of the amplifier audio out cable assemblies, which vary in cable length to accommodate the differing Amplifier Chassis mounting locations within the cabinet. Each cable assemblies have a 16-pin connector receptacle at one end for connection to Amplifier Chassis audio power connectors and two 8-pin connector receptacles at the other end for connection to a P-AADCx-G card. Each 8-pin receptacle connector carries the 100 V audio output signals of two amplifiers.

**NOTE:** The service models for the Amplifier Audio Distribution cards are K-P-AADCx-G, where x represents the number of speaker loop circuits per amplifier.

**Figure 29 P-AADC1-G and P-AADC1-G-01 Cards**

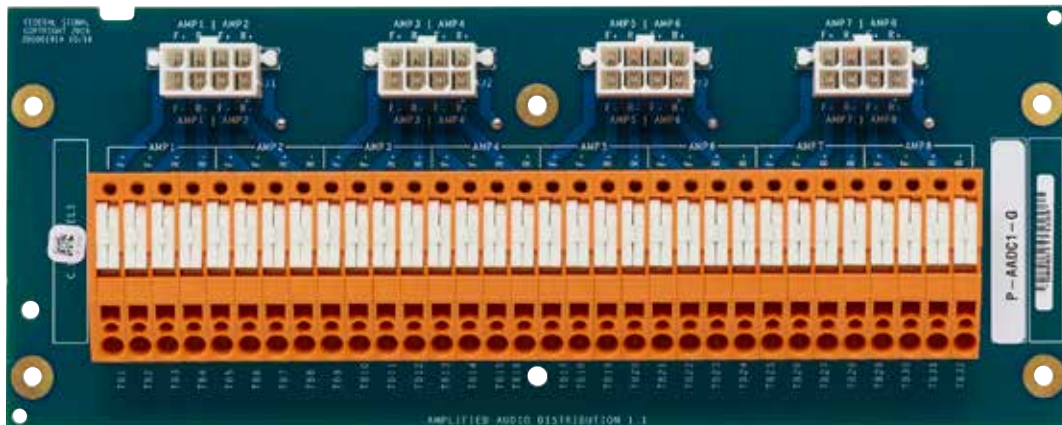

**Figure 30 P-AADC2-G and P-AADC2-G-01 Cards**

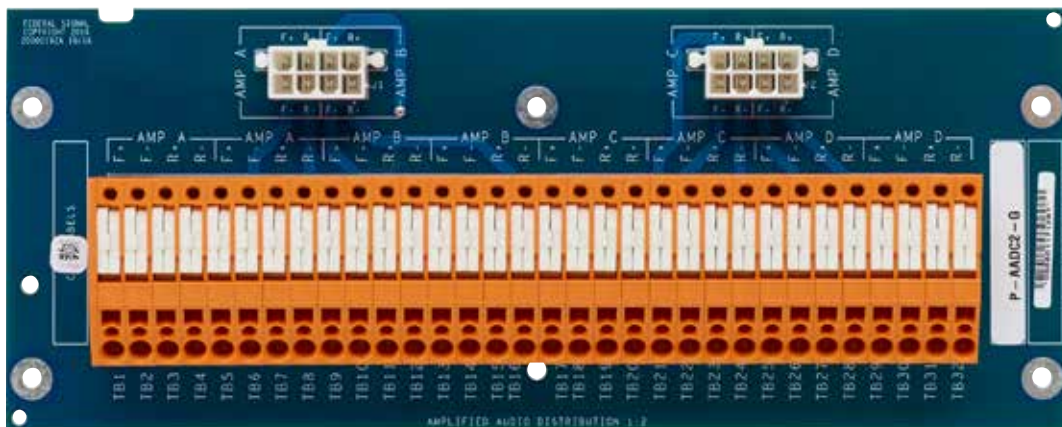

Figure 31 P-AADC4-G and P-AADC4-G-01 Cards

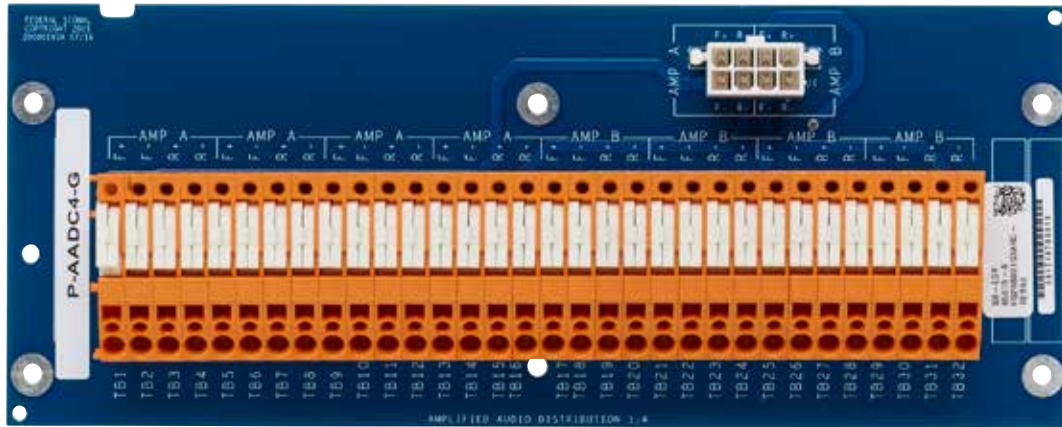
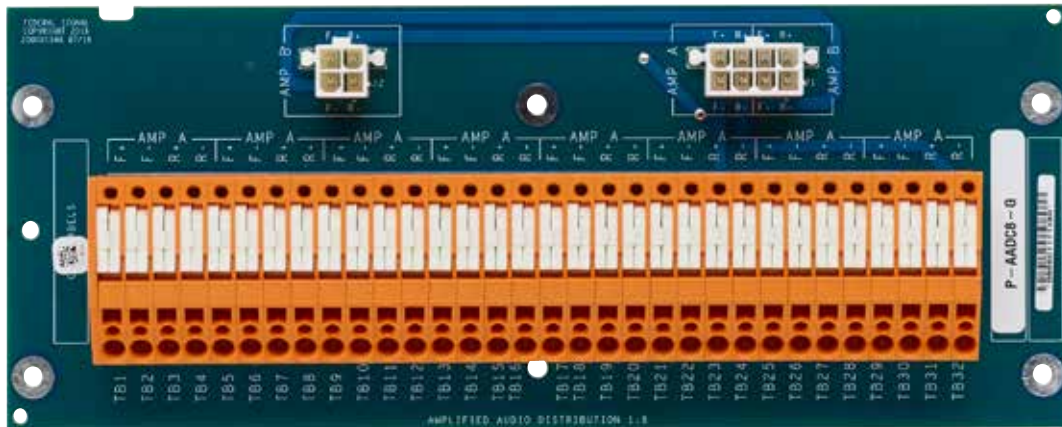

Figure 32 P-AADC8-G and P-AADC8-G-01 Cards



### 3.9.1 Amplifier Audio Distribution Terminal Block Specifications (P-AADCx-G)

Table 40 Environmental and Physical for the Amplifier Audio Distribution Terminal Block Cards (P-AADCx-G)

Operating Temperature	-25 to +55°C
Humidity	0-98% non-condensing
P-AADCx-G Dimensions (H x W x L)	28 mm x 200 mm x 79.8 mm
Weight (P-AADC1-G)	0.20 kg/0.45 lb
Weight (P-AADC2-G)	0.19 kg/0.42 lb
Weight (P-AADC4-G)	0.18 kg/0.40 lb
Weight (P-AADC8-G)	0.20 kg/0.44 lb

### 3.10 Fan Wiring Termination Card (P-FWTC-G)

The Fan Wiring Termination card (P-FWTC-G) is a passive card that provides a termination point for cabinet cooling fans. (See Figure 33.) Two cards are needed in a standard rack: one for the door-mounted cooling fans and one for the roof-mounted fans.

**NOTE:** The service model for the Fan Wiring Termination card is K-P-FWTC-G.

**Figure 33 Fan Wiring Termination Card (P-FWTC-G)**

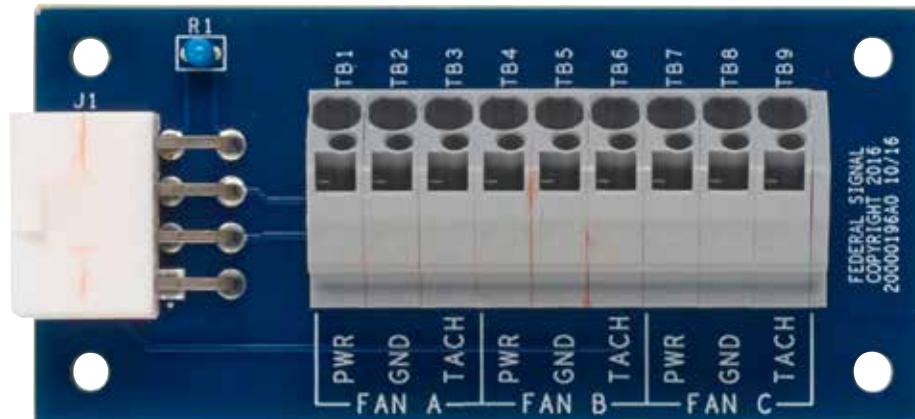

#### 3.10.1 Fan Wiring Termination Card Specifications (P-FWTC-G)

**Table 41 Environmental and Physical for the Fan Wiring Termination Card (P-FWTC-G)**

Operating Temperature	-25 to +55°C
Humidity	0-98% non-condensing
P-FWTC-G Dimensions (H x W x L)	23 mm x 81.3 mm x 38.1 mm
Weight	0.04 kg/0.08 lb

### 3.11 IS Barrier Board (P-IS-BARRIER-G)

The IS Barrier Board (P-IS-BARRIER-G) provides an Intrinsically Safe barrier between Access Panels that are mounted in a hazardous area and the PAGASYS GEN II Cabinet. (See Figure 34.) The IS Barrier Board provides two sets (A and B) of diode safety barrier circuits, each consisting of seven independent diode safety barriers.

A diode safety barrier is designed to limit the amount of energy that can appear at its output terminals. Each diode safety barrier consists of the following:

- An output resistor to limit the current
- Redundant or parallel Zener diode chains to limit the voltage
- Fuses to protect the barrier components

Each set of diode safety barriers is connected to the PAGASYS GEN II System Controller by an RJ45 socket (connectors J1 and J2) and is connected to the PAGASYS GEN II IS access panel or microphone station by an eight-way terminal block (connectors TB2 and TB3). Connector TB1 allows the Barrier Board to be grounded to an IS grounding termination bar.

**NOTE:** The service model for the IS Barrier Board card is K-P-IS-BARRIER-G.



The following tables list the TB2, TB3, and J1, and J2 Connector Signals.

**Table 42 TB2 Connector Signals (P-AP-IS-BARRIER-G)**

<b>TB2 Pin #</b>	<b>PAGASYS GEN II Access Panel IS BARRIER Signal Name</b>	<b>PAGASYS GEN II Access Panel IS BARRIER signal Function</b>
1	HAUDIO-A	AP Audio -
2	HAUDIO+A	AP Audio +
3	IS Barrier GND	AP 0V
4	H+12VA	AP +12V
5	HTX+A	AP RS422 TX+
6	HTX-A	AP RS422 TX-
7	HRX-A	AP RS422 RX-
8	HRX+A	AP RS422 RX+

**Table 43 TB3 Connector Signals (P-AP-IS-BARRIER-G)**

<b>TB3 Pin #</b>	<b>PAGASYS GEN II Access Panel IS BARRIER Signal Name</b>	<b>PAGASYS GEN II Access Panel IS BARRIER signal Function</b>
1	HAUDIO-B	AP Audio -
2	HAUDIO+B	AP Audio +
3	IS Barrier GND	AP 0V
4	H+12VB	AP +12V
5	HTX+B	AP RS422 TX+
6	HTX-B	AP RS422 TX-
7	HRX-B	AP RS422 RX-
8	HRX+B	AP RS422 RX+

**Table 44 J1 Connector Signals (P-AP-IS-BARRIER-G)**

<b>RJ45 socket J1 Pin #</b>	<b>PAGASYS GEN II Access Panel IS BARRIER Signal Name</b>	<b>PAGASYS GEN II Access Panel IS BARRIER Signal Function</b>
1	RX+A	AP RS422 RX+
2	RX-A	AP RS422 RX-
3	TX-A	AP RS422 TX-
4	AUDIO+A	AP Audio +
5	AUDIO-A	AP Audio -
6	TX+A	AP RS422 TX+
7	IS Barrier GND	AP 0V
8	+12VA	AP +12V

**Table 45 J2 Connector Signals (P-AP-IS-BARRIER-G)**

RJ45 socket J2 Pin #	PAGASYS GEN II Access Panel IS BARRIER Signal Name	PAGASYS GEN II Access Panel IS BARRIER Signal Function
1	RX+B	AP RS422 RX+
2	RX-B	AP RS422 RX-
3	TX-B	AP RS422 TX-
4	AUDIO+B	AP Audio +
5	AUDIO-B	AP Audio -
6	TX+b	AP RS422 TX+
7	IS Barrier GND	AP 0V
8	+12VB	AP +12V

**Figure 34 IS Barrier Board (P-IS-BARRIER-G)**

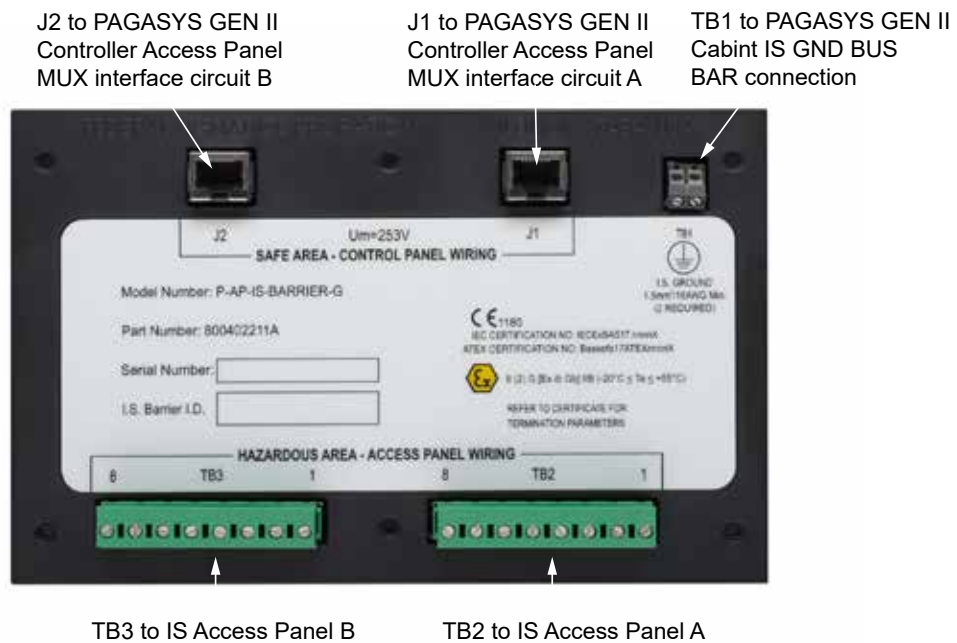

**3.11.1 IS Barrier Board Specifications (P-IS-BARRIER-G)**

**Table 46 Environmental and Physical for the IS Barrier Board (P-IS-BARRIER-G)**

Operating Temperature	-25 to +55°C
Humidity	0-98% non-condensing
P-IS-BARRIER-G Dimensions (H x W x L)	39.2 mm x 200 mm x 79.8 mm
Weight	0.51 kg/1.12 lb

### 3.12 High Integrity Card (P-NPLUS1-G)

The High Integrity I/O card (P-NPLUS1-G) is a passive card that supports I/O control selection in a high-integrity system. A high-integrity system uses redundant controllers that interface with a single set of amplifiers and I/O cards. The High Integrity I/O card selects one of the redundant I/O control signals to use for I/O card management. The High Integrity I/O card supports up to four I/O buses from two different controllers.

**NOTE:** The service model for the High Integrity I/O card is K-P-NPLUS1-G.

**Figure 35 High Integrity Card (P-NPLUS1-G)**

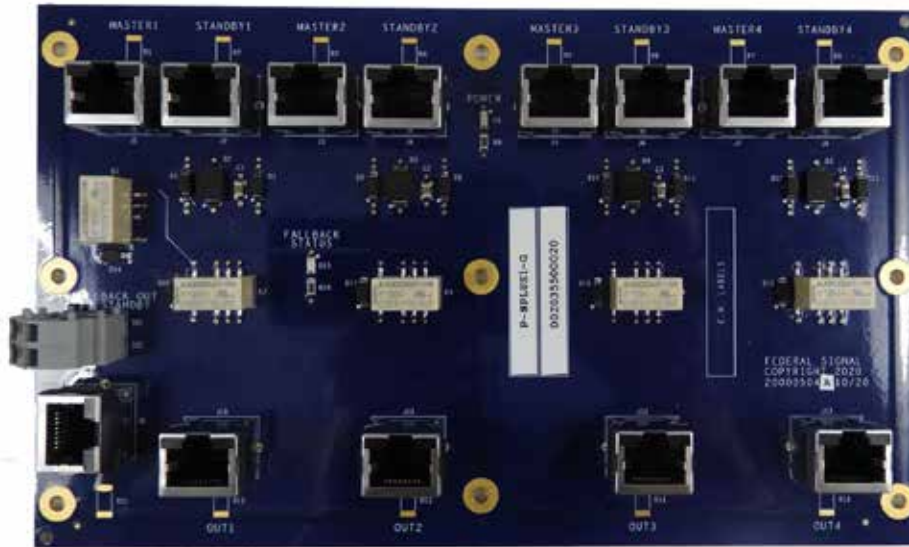

#### 3.12.1 High Integrity Card Specifications (P-NPLUS1-G)

**Table 47 Environmental and Physical for the High Integrity Card (P-NPLUS1-G)**

Operating Temperature	-25 to +55°C
Humidity	0-98% non-condensing
P-NPLUS1-G Dimensions (H x W x L)	22 mm x 200 mm x 122 mm
Weight	0.15 kg/0.34 lb

## 4.0 Access Panels

The PAGASYS GEN II system uses new low-profile Access Panels and microphone stations for Intrinsically Safe (IS) and safe area. Each Access Panel provides independent circuitry to support redundant A/B systems and offers a common microphone for the redundant systems.

**Figure 36 Picture of Desktop Access Panel**



**Table 48 Access Panel and Microphone Station Models**

Model	Description
P-AP-EXDM-G	Access Panel IS Desk Mount GEN II. Requires separate purchase of IS Barrier Boards in cabinet. (Model P-IS-BARRIER-G)
P-AP-SADM-G	Access Panel Safe Area Desk Mount GEN II.
P-AP-EXWM-G	Access Panel IS Wall Mount GEN II. Requires separate purchase of IS Barrier Boards in cabinet. (Model P-IS-BARRIER-G)
P-AP-SAWM-G	Access Panel Safe Area Wall Mount GEN II.
P-AP-EX19-G	Access Panel IS Rack Mount GEN II. Requires separate purchase of IS Barrier Boards in cabinet. (Model P-IS-BARRIER-G)
P-AP-SA19-G	Access Panel Safe Area Rack Mount GEN II
P-MIC-EXWM1-316-G	PAGASYS GEN II Mic Station. Intrinsically safe (requires a separate purchase of two IS Barrier Boards in cabinet, (model P-IS-BARRIER-G), wall mount, IP66, SS316 enclosure, one pushbutton, stubby microphone.

The PAGASYS GEN II Access Panels and microphone stations provide the following functions:

- Monitoring of access panel keypad switches
- Control of an access panel visual and audio indicators
- RS422 Data communication with PAGASYS GEN II System Controller through an Internal AP MUX card or an external AP Aggregator card.

- Local microphone preamplifier and audio line driver
- A 20 kHz monitoring tone, which is used to confirm the audio signal path between the microphone station to the PAGASYS GEN II System Controller

## 5.0 Removing and Installing the Controller Chassis

### 5.1 Removing the Controller Chassis

#### 5.1.1 Removing the front cover

To remove the front cover, press the latch near the right handle and remove the front cover to expose the dust filter and cable connections.

#### 5.1.2 Removing Power from the Controller Chassis

To remove power from the Controller Chassis, place the breaker switch in the off (that is, the down) position.

**Figure 37 Breaker Switches**

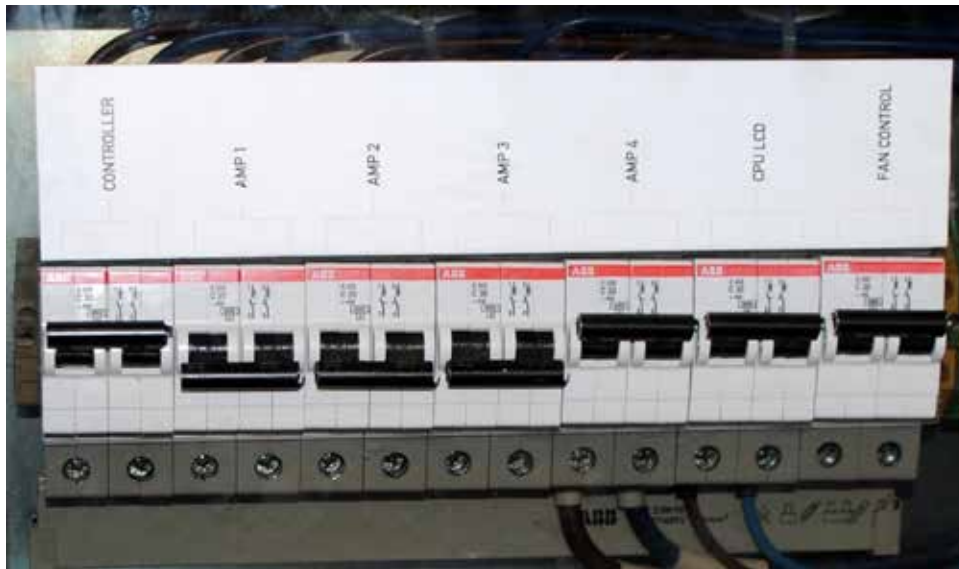

#### 5.1.3 Disconnecting the Controller Chassis cables from the Chassis

To disconnect the Controller Chassis cable from the chassis:

1. Write down or photograph the labels and connector positions of all the cables exposed by the removed front cover.
2. Unplug the cables from the top and bottom RJ45 jack sockets located on the Amplifier Audio Mux.
3. Unplug the cables from the top and bottom RJ45 jack sockets located on the card installed in the AP Mux slot 1.
4. Unplug the cables from the top and bottom RJ45 jack sockets located on the card installed in the AP Mux slot 2.
5. Unplug the cables from the RJ45 jack sockets located on the Processor card.
6. Unplug the USB cables from the USB A and USB B cable jack sockets located on the Processor card.
7. Unplug the RS232 cable from the nine-way D socket located on the Processor card.
8. Unplug the cables from the RJ45 jack sockets located on the Miscellaneous I/O card.

9. Unplug the cables from the RJ11 jack sockets located on the Miscellaneous I/O card.
10. Unplug the RS232 cable from the nine-way D socket located on the Miscellaneous I/O card.
11. Unplug the cables from the RJ45 jack sockets located on the I/O Interface card.
12. Move the cables out of the way to enable the removal of the chassis.
13. Undo the front captive retaining screws under the left and right handles.
14. Carefully and slowly slide the Controller Chassis out of the cabinet. Be ready to hold its weight once it slides all the way out.

### 5.1.4 Removing the Internal Cards

CMOS circuitry is incorporated within this equipment.

#### **NOTICE**

***EQUIPMENT DAMAGE: Observe Electrostatic Discharge precautions when removing, installing, and servicing the Controller Chassis.***

***Do not connect power or any cables to the internal circuit boards removed from the cabinet.***

To remove the internal cards:

1. Remove the Controller Chassis from the cabinet.
2. Undo the top cover retaining screws on the upper right, rear and left edges of the Controller Chassis.
3. Carefully lift the metal top cover. The internal cards are now visible.
4. Select the required internal card to remove.

To remove the card, grip the selected internal card at each end of its top edge and pull the card vertically upwards to release the card from the chassis.

#### **NOTICE**

***EQUIPMENT DAMAGE: Do not pull the card from one end only because this may damage the cards connector(s) or the Chassis Backplane connectors.***

### 5.1.5 Removing the Controller Backplane

After the Controller Chassis is removed from the cabinet and the controller cards are removed from the backplane, you then have access to the controller backplane.

To remove the Controller Backplane:

1. Once the chassis has been removed from the cabinet, undo the top cover retaining screws on the upper right rear and left edges of the Controller Chassis.
2. Carefully lift the metal top cover. The internal cards are now visible.
3. Remove the internal cards as per the procedure above.
4. Make a note of all wire labels, colors, and positions connected to the backplane.

## Removing and Installing the Controller Chassis

---

5. Remove the 5 screws from the backplane's 4-mm card mount terminal lugs J10 through to J14.
6. Disconnect the 5 wires from the screws and refit screws to terminal lugs.
7. Remove the 12 backplane fixing screws and store them for future use.
8. Lift the backplane out of the chassis.

## 5.2 Installing the Controller Chassis

### 5.2.1 Installing the Controller Backplane

To install the Controller Backplane:

1. Place the backplane into the chassis with the DIN connector facing up. The daughterboard DIN connectors should be toward the front of the chassis, and 5 x 4 mm card mount terminal lugs J10 through to J14 toward the rear of the chassis.
2. Align the backplane with its mounting post and fit the fixing screws
3. Connect the 5 wires to the backplane terminal lugs.
4. Fit all controller daughter boards and modules for internal card installation into the chassis. Refer to Installing the Internal Cards below.

### 5.2.2 Installing the Internal Cards

To install the internal cards:

1. Position the internal card to be installed so that its rear edge is located in the appropriate card guides punched into the rear of the Controller Chassis and that its faceplate is located in the appropriate slot in the floor of the Controller Chassis. The internal card to be installed is now located just above its backplane connectors.

**Figure 38 Card Guides in Controller Chassis**

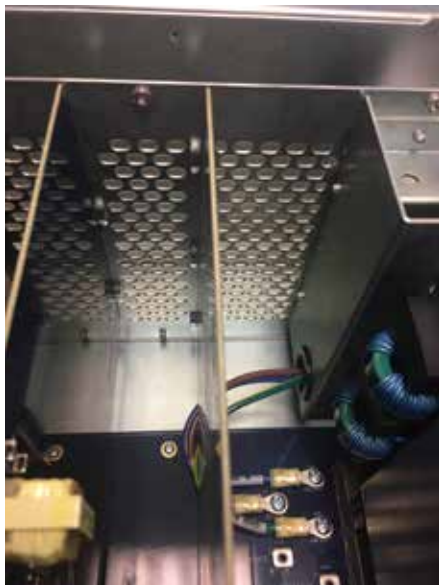

2. Carefully press the internal card vertically downward to mate it with its backplane connectors.



3. Once all internal cards have been installed in their correct locations, refit the Controller Chassis top cover, and refit the top cover retaining screws.

### 5.2.3 Installing the Controller Chassis

To install the Controller Chassis:

1. Temporarily secure all cables out of the way to allow the Controller Chassis to slide into its vacant cabinet position.
2. Carefully slide the Controller Chassis into the cabinet, ensuring that no cables are pinched in the process.
3. Tighten the front retaining screws.
4. Plug all the cables into their correct positions. (See the next section, Installing the Controller Chassis cables.)
5. Attach the front cover, using three slots on the left side as hinges and carefully closing like a door on the right side until the latch clicks in position.

### 5.2.4 Installing the Controller Chassis Cables

See the PAGASYS GEN II System Controller Technical Installation Guide for detailed specifications on Controller card wiring connections.

To connect the Controller Chassis cables to the chassis:

1. After the Controller Chassis is installed in the cabinet (see the prior section, Installing the Controller Chassis) and before the front cover is attached, install the cables.
2. Plug the following cables into the RJ45 jack sockets located on the I/O Interface card.
  - I/O port 1, yellow cable, coming from P-16DIN-G serial port
  - I/O port 2, orange cable, coming from P-FCMC-G serial port
  - I/O port 3, green cable, coming from P-SPDT-G serial port
  - I/O port 4, blue cable, coming from P-BK-MON-G serial port

**Figure 39 Cables Connected into RJ45 Jack Socket**



**I/O Interface Card  
4 x RJ45 Cables (RS485 Serial)**

## Removing and Installing the Controller Chassis

---

4. Plug the RS232 cable into the nine-way D socket located on the Miscellaneous I/O card.
5. Plug the microphone cable into the RJ11 jack sockets located on the Miscellaneous I/O card.
6. Plug the auxiliary audio cables into the RJ45 jack sockets located on the Miscellaneous I/O card.

**Figure 40 Cables Connected on the Miscellaneous I/O Card**

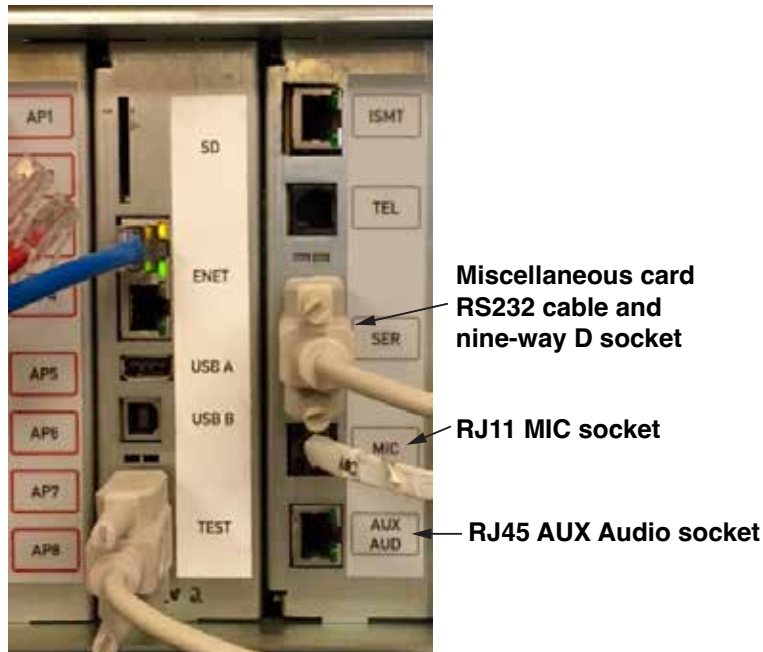

7. Plug the RS232 cable into the nine-way D socket located on the Processor card.
8. Plug any USB cables into the USB A and USB B cable jack sockets located on the Processor card.
9. Plug the Ethernet cables from the System Manager server into the RJ45 jack sockets located on the Processor card.

Figure 41 Cable Connections on the Processor Card

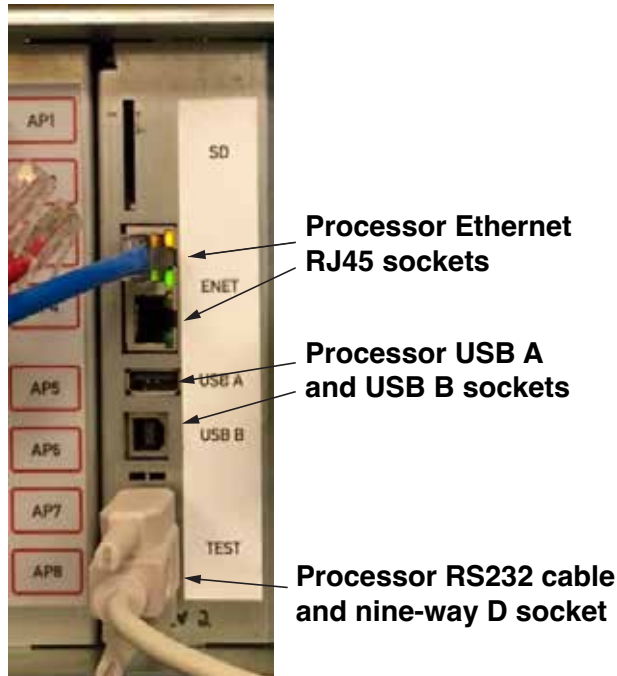

Cable wiring for the AP Mux slot 1 and 2 are differentiated by the type of AP Mux card inserted in the slot:

- If the Internal AP Mux card (P-IAMC-G) is present, insert the RJ45 cables from the Access Panels into the (8) RJ45 sockets on the front of the card.
- If the External AP Mux card (P-EAMC-G) is present in the slot, insert the RJ45 cables from the Access Panel Aggregator card into the (4) RJ45 sockets on the top of the card.

Figure 42 Internal AP Mux Card Connections



**Figure 43 External AP Mux Card Connections**



10. Plug the cables from the Access Panels or Access Panel Aggregator card into the RJ45 jack sockets located on the card installed in the AP Mux slot 2.
11. Plug the cables from the Access Panels or Access Panel Aggregator card into the RJ45 jack sockets located on the card installed in the AP Mux slot 1.
12. Plug the RJ45 cables from the amplifiers into the input/output RJ45 jack sockets located on the top of the Amplifier Audio Mux.
13. Plug the fireman's microphone into the fireman's microphone socket, if available.

**Figure 44 Connections**



14. Write down or photograph the labels and connector positions of all the cables exposed by the removed front cover.

## 5.3 Removing and Installing the Amplifier Chassis (From Cabinet)

### 5.3.1 Safety Instructions

**⚠ DANGER**

***ELECTROCUTION HAZARD: This equipment is part of a Voice Alarm System, and there is the possibility of dangerous voltages being present in the main equipment rack.***

***Internal servicing must be performed by a competent, qualified engineer.***

### 5.3.2 Recommendation for the Equipment Location

Avoid locating the equipment:

- Near heat sources
- In direct sunlight
- Where it is exposed to high humidity or dust levels

### 5.3.3 Preparing Amplifier Installation and Removal

CMOS circuitry is incorporated within this equipment. Observe Electro-Static Discharge precautions when removing, installing, and servicing amplifiers.

**⚠ DANGER**

***ELECTROCUTION HAZARD: Before removing or installing an amplifier, turn off the circuit breaker supplying power to the unit. Do not use the power buttons on the front panel.***

### 5.3.4 Removing the Amplifier Chassis

To remove the Amplifier Chassis:

1. Press a latch near the right handle and remove the front cover to expose the dust filter and cable connections. (See Figure 15.)
2. Write down or photograph the labels and positions of all the cables exposed by the removed front cover.
3. Unplug four audio/control signal cables on the bottom left. Unplug one large 100 V audio output cable in the bottom center. Unplug two standby cables on the bottom right.
4. Move the cables out of the way of the chassis.
5. Undo the front captive retaining screws under the left and right handles.
6. Carefully and slowly slide the Amplifier Chassis out. Be ready to hold its weight once it slides all the way out.

### 5.3.5 Installing the Amplifier Chassis

To install the Amplifier Chassis:

1. Temporarily secure the cables out of the way of the Amplifier Chassis to be placed in the empty chassis position.
2. Carefully slide the Amplifier Chassis into its mainframe position, ensuring that no cables are pinched in the process.
3. Tighten the front retaining screws.
4. Plug all the cables into their former positions as previously recorded.
5. Attach the front cover, using three slots on the left side as hinges and carefully closing like a door on the right side until the latch clicks in position.

### 5.3.6 Replacing the Internal Cards

#### **NOTICE**

**EQUIPMENT DAMAGE: CMOS circuitry is incorporated within this equipment. Observe Electrostatic Discharge precautions when removing, installing, and servicing amplifiers.**

**Do not connect power or any cables to the amplifier removed from the cabinet.**

### 5.3.7 Removing the Amplifier Card

After the Amplifier Chassis is removed from the cabinet and all cables are disconnected, you then have access to the Amplifier Chassis.

To remove the Amplifier Card:

1. Undo the top cover retaining screws on the upper right and left edges of the chassis.
2. Carefully lift the metal top cover. Four vertical amplifier cards (modules) are now visible.  
**NOTE:** To remove an amplifier card, disconnect all its internal cables.
3. Unplug the front panel cable on the top edge.

**Figure 45 Front Panel Cable**



4. Unplug the fan cable near the front fan.

**Figure 46 Fan Cable**



5. Unplug the upper transformer plug.
6. Unplug the lower transformer plug.

### **5.3.8 Installing the Amplifier Card**

To install the amplifier card:

1. Temporarily secure the cables out of the way of the amplifier card to be placed in the empty position.
2. Observe the rear holding rail formed by metal notches on the back wall. Keep the board between these notches as it slides down.
3. Place the amplifier card in the top portion of the front plastic rail and between the first two notches of the back rail.

**Figure 47 Amplifier Card in the Top Portion of the Front Plastic Rail**



4. Slowly slide the card down while ensuring that no wire gets under the board.
5. Check the alignment of the backside of the card between the metal notches.
6. The front plastic rail has a step on which the card may stop when it is 80% of the way down. In such a case, grab the card by only the back handle and lift it slightly (by 2 mm or 0.1 in) so that the front clears the step of the plastic rail. The card then easily slides the rest of the way down, gently resting on the connection headers.

## Removing and Installing the Controller Chassis

---

**NOTE:** Prepare the card for the final step of insertion into the connection headers.

7. Ensure that all three headers on the bottom are aligned.
8. Ensure that the metal handles are in the 20-degree and 60-degree angle up from horizontal, with the front handle short end under the metal ridge and the rear handle short end in the slot of the back wall.

**Figure 48 Metal Handles in the 20-degree and 60-degree Angle**



9. Push both handles down to their horizontal position. This inserts the card plugs into their headers.
10. Reconnect all cable connectors into their proper locations:
  - Insert the lower transformer plug into its header while observing its polarity.
  - Insert the upper transformer plug into its header while observing its polarity.
  - Insert the fan connector into its header while observing its polarity.
  - Insert the front panel connector on the top edge while observing its polarity.

**Figure 49 Lower Transformer Plug**





11. The amplifier card has two black metal handles. Lift both handles at the same time and open them up, turning by an angle greater than 90 degrees.

**Figure 50 Two Black Handles on Amplifier Card**



12. Holding by the open handles, carefully slide the card out of the chassis.

### 5.3.9 Removing the ISMT Card (Optional)

After the Amplifier Chassis is removed from the cabinet and all the cables are disconnected, you then have access to the internal cards.

To remove the ISMT card:

1. Undo the top cover retaining screws on the upper right and left edges of the chassis.
2. The optional vertical ISMT card is located on the right side. This card is shorter than the amplifier cards.
3. To remove the optional ISMT card, lift the black metal handle in the front top corner, turning it up by more than 90° and then carefully slide the card up the holding rails.

**Figure 51 Removing the ISMT Card**



### 5.3.10 Installing the ISMT Card (Optional)

To install the ISMT card:

1. Observe the rear holding rail formed by metal notches on the back wall. Keep the card between these notches as it slides down.
2. Place the ISMT card in the top portion of the front plastic rail and between the first two notches of the back rail.
3. Carefully slide the card down until its plug gently rests on the header of the motherboard.
4. Check the alignment of the backside of the card between the metal notches.

5. Ensure that the metal handle is in the 30° and 60° angle up from horizontal, with the end under the metal ridge.
6. Fully insert the card into its header, pushing the handle into a horizontal position while also applying pressure on the other end of the card (without handle).

To configure the Amplifier Chassis for ISMT after installing the ISMT card, see “9.0 Configuring the Amplifier Chassis” on page 96.

## 6.0 Installing and Configuring the I/O Cards

### 6.1 Main Distribution Frame (MDF)

The PAGASYS GEN II system has been designed to incorporate the Main Distribution Frame (MDF) in the same cabinet as the control and amplification equipment. This area of the cabinet is used to mount system cards that receive terminations from field equipment such as power equipment, beacons, speakers, access panels, and any other terminations to be handled by the system.

**Figure 52 Main Distribution Frame (MDF)**



The MDF contains three areas for mounting terminating equipment: left panel, right panel, and back panel. The left panel is used to mount amplifier audio distribution terminal cards for loudspeaker terminations. The right panel is used for power terminations and mounting the Beacon Monitored Output card. The back panel is used to mount any of the system I/O cards.

Figure 53 Areas for Mounting Terminating Equipment

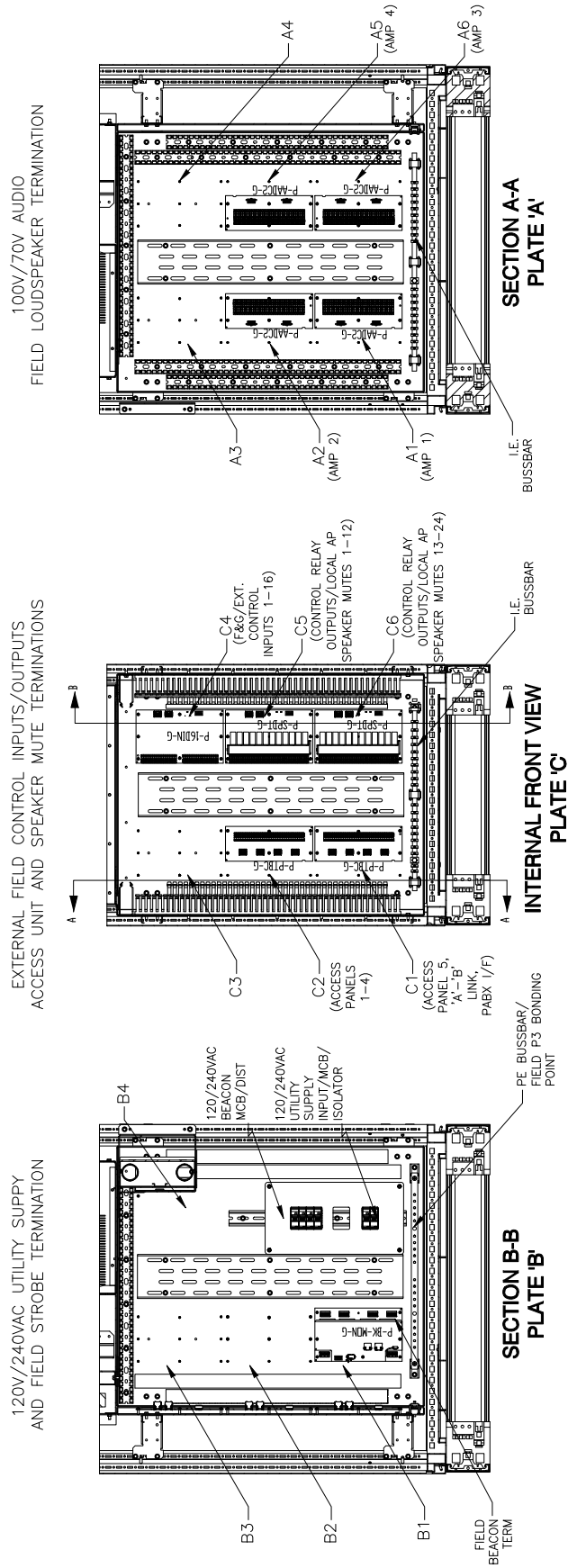

(STANDARD CARD CONFIGURATION SHOWN WITH TERMINATION REFERENCE INFO SHOWN IN PARENTHESIS)

### **6.2 Digital Input Card (P-16DIN-G)**

#### **6.2.1 Removing the Digital Input Card**

To remove the Digital Input Card (P-16DIN-G):

- 1.** Before removing the P-16DIN-G card, ensure that all AC and DC power supplies serving the cabinet are turned off and isolated.
- 2.** Referencing the cabinet wiring drawings and the Technical Installation Guide, disconnect the P-16DIN-G connectors to the system cables in the following manner:
  - Disconnect the I/O Bus CAT 5 cables from card mount RJ45 sockets J2 and J3.
  - Disconnect the digital input wires from TB1 and TB2.
- 3.** While supporting the P-16DIN-G, remove the screws that hold the P-16DIN-G on its mounting pillars. Store the screws in a safe place for reuse.
- 4.** Remove the P-16DIN-G from its mounting pillars.

#### **6.2.2 Installing and Configuring the Digital Input Card (P-16DIN-G)**

The Digital Input card is a panel-mount card assembly that is mounted on the Rear I/O panel in the lower part of the front access cabinet. After installation, the digital input card must have its I/O Bus address set. See the PAGASYS GEN II Digital Input Technical Installation Guide for more information on configuring the I/O Bus address.

To install and configure the Digital Input Card (P-16DIN-G):

- 1.** Before installing the P-16DIN-G card, ensure that all AC and DC power supplies serving the cabinet are turned off and isolated.
- 2.** Place the P-16DIN-G card on to its housing mounting pillars and fasten to the pillars using the screws supplied or previously removed.
- 3.** Referencing the cabinet wiring drawings and the Technical Installation Guide, connect the P-16DIN-G connectors to the system cables in the following manner:
  - Connect the digital input wires to TB1 and TB2.
  - Connect the I/O Bus CAT 5 cables to card mount RJ45 sockets J2 and J3.

See the PAGASYS GEN II System Manager Software User Manual for more information on configuring the digital input card and its inputs.

## **6.3 Beacon Monitored Card (P-BK-MON-G)**

### **6.3.1 Removing the Beacon Monitored Card (P-BK-MON-G)**

To remove the Beacon Monitored card (P-BK-MON-G):

1. Before removing the P-BK-MON-G card, ensure that all AC and DC power supplies serving the cabinet are turned off and isolated.
2. While referencing the cabinet wiring drawings and the Technical Installation Guide, disconnect the P-BK-MON-G connectors to the system cables in the following manner:
  - a. Disconnect the I/O Bus CAT 5 cables from the top card RJ45 sockets J3 and J4.
  - b. Disconnect and make safe the Beacon circuit 1 AC supply wires from the bottom card Terminal block TB1.
  - c. Disconnect and make safe the Beacon circuit 2 AC supply wires from the bottom card terminal block TB2.
  - d. Disconnect the Beacon circuit 1 AC Load Out wires from the bottom card terminal block TB3.
  - e. Disconnect the Beacon circuit 1 AC Load In wires from the bottom card terminal block TB4.
  - f. Disconnect the Beacon circuit 2 AC Load Out wires from the bottom card terminal block TB5.
  - g. Disconnect the Beacon circuit 2 AC Load wires from the bottom card in terminal block TB6.
3. While supporting the P-BK-MON-G card, remove the screws that hold the P-BK-MON-G card on its mounting pillars. Store the screws in a safe place for reuse.
4. Remove the P-BK-MON-G card from its mounting pillars.

### **6.3.2 Installing and Configuring the Beacon Monitored Card (P-BK-MON-G)**

The Beacon Monitored card is a panel-mount card assembly that is mounted on the Power I/O panel in the lower part of the front access cabinet. After installation, the Beacon Monitored card must have its I/O Bus address set. See the PAGASYS GEN II Beacon Monitored Technical Installation Guide for more information on configuring the I/O Bus address.

The P-BK-MON-G module assembly contains two cards separated by spacers and a metal shield and connected by two cable looms. The lower card provides the Beacon Circuit Field Terminal blocks and relay switching circuitry for two independent beacon circuits. The upper card provides an on-board microprocessor, which coordinates the operation of the card, including the relays mounted on the lower card.

To install and configure the Beacon Monitored card (P-BK-MON-G):

1. Before removing or installing the P-BK-MON-G card, ensure that all AC and DC power supplies serving the cabinet are turned off and isolated.
2. Place the P-BK-MON-G card onto its housing mounting pillars and fasten to the pillars using the screws supplied or previously removed.

3. Referencing the cabinet wiring drawings and the Technical Installation Guide, connect the P-BK-MON-G card connectors to the system cables in the following manner:
  - a. Connect the Beacon circuit 1 AC Load Out wires from the bottom card terminal block TB3.
  - b. Connect the Beacon circuit 1 AC Load In wires from the bottom card terminal block TB4.
  - c. Connect the Beacon circuit 2 AC Load Out wires from the bottom card terminal block TB5.
  - d. Connect the Beacon circuit 2 AC Load wires from the bottom card in terminal block TB6.
  - e. Connect and make safe the Beacon circuit 1 AC supply wires from the bottom card Terminal block TB1.
  - f. Connect and make safe the Beacon circuit 2 AC supply wires from the bottom card terminal block TB2.
  - g. Connect the I/O Bus CAT 5 cables from the top card RJ45 sockets J3 and J4.

## 6.4 Relay Output Card (P-SPDT-G)

### 6.4.1 Removing the Relay Output Card (P-SPDT-G)

**⚠ WARNING**

***SHOCK HAZARD: External equipment connected to the P-SPDT-G relay contacts may still continue to provide live voltages to its terminals. Before disconnecting wires from terminals, which are connected to external equipment, ensure that the external equipment is shut down or the wires are made safe at the external equipment.***

To remove the Relay Output card (P-SPDT-G):

1. Before removing the P-SPDT-G card, ensure that all AC and DC power supplies serving the cabinet are turned off and isolated.
2. While referencing the cabinet wiring drawings and the Technical Installation Guide, disconnect the P-SPDT-G connectors to the system cables in the following manner:
  - a. Disconnect the I/O Bus CAT 5 cables from the card mount RJ45 sockets J1 and J2.
  - b. Disconnect the wires from TB1 pins 1 to 36.
3. While supporting the P-SPDT-G card, remove the screws that hold the P-SPDT-G on its mounting pillars. Store the screws in a safe place for reuse.
4. Remove the P-SPDT-G card from its mounting pillars.

### **6.4.2 Installing and Configuring the Relay Output Card (P-SPDT-G)**

The Relay Output card is a panel-mount card assembly that is mounted on the Rear I/O panel in the lower part of the front access cabinet. After installation, the Relay Output card must have its I/O Bus address set. See the PAGASYS GEN II Relay Output Card Technical Installation Guide for more information on configuring the I/O Bus address.

To install and configure the Relay Output card (P-SPDT-G):

1. Before removing or installing the P-SPDT-G card, ensure that all AC and DC power supplies serving the cabinet are turned off and isolated.
2. Place the P-SPDT-G card onto its housing mounting pillars and fasten to the pillars using the screws supplied or previously removed.
3. Referencing the cabinet wiring drawings and the Technical Installation Guide, connect the P-BK-MON-G connectors to the system cables in the following manner:
  - a. Connect the wires to TB1 pins 1 to 36
  - b. Connect the I/O Bus CAT 5 cables to the card mount RJ45 sockets J1 and J3.

## **6.5 Fan Control and Monitoring Card (P-FCMC-G)**

### **6.5.1 Removing the Fan Control and Monitoring Card (P-FCMC-G)**

To remove the Fan Control and Monitoring card (P-FCMC-G):

1. Before removing the P-FCMC-G card, ensure that all AC and DC power supplies serving the cabinet are turned off and isolated.
2. Remove the fixing screws from the P-FCMC-G Perspex® finger guard and remove the Perspex finger guard. Store the Perspex finger guard and fixing screws in a safe place because they must be refitted before the PAGASYS GEN II system is placed back into operation.
3. While referencing the rack wiring drawings, disconnect the P-FCMC-G connectors to the system cables in the following manner:
  - a. Disconnect the AC supply cable loom assembly From TB1.
  - b. Disconnect the I/O Bus CAT 5 cables from card mount RJ45 sockets J1 and J2.
  - c. Disconnect transformer number 2 secondary cable assembly from TB6.
  - d. Disconnect transformer number 1 secondary cable assembly from TB4.
  - e. Disconnect transformer number 2 primary cable assembly from TB5.
  - f. Disconnect transformer number 1 primary cable assembly from TB3.
  - g. Disconnect the AC supply cable loom assembly from TB1.
  - h. Disconnect the External DC supply cable from TB2.
  - i. Disconnect the bottom fan cable assembly socket from card mount Molex® minifit connectors J3.
  - j. Disconnect the Top fan cable assembly socket from card mount Molex minifit connectors J4.

4. While supporting the P-FCMC-G card, remove the fixing screws and threaded mounting pillars that hold the P-FCMC-G card on its mounting pillars. Store the fixing screws and threaded mounting pillars in a safe place for reuse.
5. Remove the P-FCMC-G card from its mounting pillars.

### 6.5.2 Installing and Configuring the Fan Control and Monitoring Card (P-FCMC-G)

The P-FCMC-G card is a panel-mount card assembly connected to two off-board toroidal mains transformers. After installation, the Fan Control and Monitoring card must have its I/O Bus address set. See the PAGASYS GEN II Fan Control and Monitoring Card Technical Installation Guide for more information on configuring the I/O Bus address.

 **CAUTION**

***SHOCK HAZARD: The Fan Control and Monitoring card is provided with a Perspex® finger guard to prevent operator and service personnel from coming into contact with hazardous voltage present on this card. This guard must always be in place when the unit is energized.***

The external transformers provide 3000 V of electrical isolation between primary and secondary windings and provide a secondary terminal voltage of 36 Vac or 18 Vac from an applied primary voltage 230 Vac or 115 Vac, respectively.

To install and configure the Fan Control and Monitoring card (P-FCMC-G):

1. Before removing or installing the P-FCMC-G card, ensure that all AC and DC power supplies serving the cabinet are turned off and isolated.
2. Place the P-FCMC-G card on to its housing mounting pillars and fasten to the pillars using the fixing screws and threaded mounting pillars supplied or previously removed.
3. While referencing the cabinet wiring drawings and the Technical Installation Guide, connect the P-FCMC-G connectors to the system cables in the following manner:
  - a. Connect the top fan cable assembly socket to card mount Molex® minifit connectors J4.
  - b. Connect the bottom fan cable assembly socket to card mount Molex minifit connectors J3.
  - c. If specified in the cabinet wiring drawings and the Technical Installation Guide, connect the External DC supply cable to TB2.
  - d. Connect transformer number 1 primary cable assembly to TB3.
  - e. Connect transformer number 2 primary cable assembly to TB5.
  - f. Connect transformer number 1 secondary cable assembly to TB4.
  - g. Connect transformer number 2 secondary cable assembly to TB6.
  - h. Connect the I/O Bus CAT 5 cables to card mount RJ45 sockets J1 and J2.
  - i. Connect the AC supply cable loom assembly to TB1.
4. Place the P-FCMC-G Perspex finger guard onto its mounting pillars and fasten to the mounting pillars using the fixing screws supplied or previously removed.



**⚠ WARNING**

**ELECTROCUTION HAZARD: The Perspex® finger guard must be fitted to protect operators and service personnel from coming into contact with hazardous voltages. Removal of the finger guard renders the PAGASYS GEN II equipment unsafe and therefore must not be operated with it removed.**

## 6.6 Monitored Input Card (P-MONIC-G)

### 6.6.1 Removing the Monitored Input Card (P-MONIC-G)

To remove the Monitored Input card (P-MONIC-G):

1. Before removing the P-MONIC-G card, ensure that all AC and DC power supplies serving the cabinet are turned off and isolated.
2. While referencing the cabinet wiring drawings and the Technical Installation Guide, disconnect the P-MONIC-G connectors to the system cables in the following manner:
  - a. Disconnect the I/O Bus CAT 5 cables from card mount RJ45 sockets J1 and J2.
  - b. Disconnect the monitored input wires from TB1 and TB2.
3. While supporting the P-MONIC-G card, remove the screws that hold the P-MONIC-G card on its mounting pillars. Store the screws in a safe place for reuse.
4. Remove the P- P-MONIC-G card from its mounting pillars.

### 6.6.2 Installing and Configuring the Monitored Input Card (P-MONIC-G)

The Monitored Input card is a panel-mount card assembly that is mounted on the Rear I/O panel in the lower part of the front access cabinet. After installation, the Monitored Input card must have its I/O Bus address set. See the PAGASYS GEN II Monitored Input Module Technical Installation Guide for more information on configuring the I/O Bus address.

The P-MONIC-G module assembly contains two cards separated by spacers that are connected through a cable loom. The lower card provides the field terminals and the 16 monitored input measurement circuits. The upper card provides a microprocessor that coordinates the scanning of 16 monitored input circuits and reports the status of the monitored inputs to the Controller.

To install and configure the Monitored Input card (P-MONIC-G):

1. Before removing or installing the P-MONIC-G card, ensure that all AC and DC power supplies serving the cabinet are turned off and isolated.
2. Place the P-MONIC-G card on to its housing mounting pillars and fasten to the pillars using the screws supplied or previously removed.
3. While referencing the cabinet wiring drawings and the Technical Installation Guide, connect the P-MONIC-G connectors to the system cables in the following manner.
  - a. Connect the digital input wires to TB1 and TB2.
  - b. Connect the I/O Bus CAT 5 cables to card mount RJ45 sockets J1 and J2.

## **6.7 Passive Terminal Block Card (P-PTBC-G)**

### **6.7.1 Removing the Passive Terminal Block Card (P-PTBC-G)**

To remove the Passive Terminal Block card (P-PTBC-G):

1. Before removing or installing the P-PTBC-G card, ensure that all AC and DC power supplies serving the cabinet are turned off and isolated. This should remove any live voltages generated with the cabinet from the terminal blocks of the P-PTBC-G card.
2. While referencing the rack wiring drawings and the Technical Installation Guide, disconnect the P-PTBC-G connectors to the system cables in the following manner.
  - a. Disconnect the cables from RJ45 connectors J1 through J4
  - b. Disconnect the Access Panel wires from TB1 pins 1 through 33.
3. While supporting the P-PTBC-G card, remove the screws that hold the P-PTBC-G card on its mounting pillars. Store the screws in a safe place for reuse.
4. Remove the P-PTBC-G card from its mounting pillars.

### **6.7.2 Installing and Configuring the Passive Terminal Block Card (P-PTBC-G)**

Avoid locating the equipment near heat sources, in direct sunlight, and where it is exposed to high humidity or dust levels.

Before removing or installing the P-PTBC-G card, ensure that all AC and DC power supplies serving the cabinet are turned off and isolated.

**⚠ WARNING**

***AUTOMATIC EQUIPMENT WARNING: This equipment is part of an automated system. When installing or servicing this equipment or any other part of the warning system, you must be aware that the system could energize circuits and signals at any time. Use extreme caution to protect yourself from electric shock, loud sounds, and bright light that could be generated by the system. To avoid these hazards, always disconnect power to all of the system and its components, including battery backup power supplies when installing or servicing any part of the warning system.***

To install and configure the Passive Terminal Block card (P-PTBC-G):

1. Ensure that the AC or DC power supplies serving the P-PTBC-G card and all other connected equipment are turned off and isolated.
2. Place the P-PTBC-G card on to its housing mounting pillars and fasten to the pillars using the screws supplied or previously removed.
3. While referencing the cabinet wiring drawings and the Technical Installation Guide, connect the P-PTBC-G connectors to the system cables in the following manner.
  - a. Connect the Access Panel wires from TB1 pins 1 through 32.
  - b. Connect the cables from RJ45 connectors J1 through J4.

## 6.8 Cable Power Injector I/O Card (P-CPIC-G)

### 6.8.1 Removing the Cable Power Injector I/O Card (P-CPIC-G)

To remove the Cable Power Injector I/O card (P-CPIC-G):

1. Before removing or installing the P-CPIC-G card, ensure that all AC and DC power supplies serving the cabinet are turned off and isolated. This should remove any live voltages generated with the cabinet from the terminal blocks of the P-CPIC-G card.
2. While referencing the rack wiring drawings, disconnect the P-CPIC-G connectors to the system cables in the following manner.
  - a. Disconnect the cables from RJ45 connectors J1 and J2.
  - b. Disconnect the cables from RJ45 connectors J8 and J9.
  - c. Disconnect the cables from card header J3 and J10.
  - d. Disconnect the cables from RJ45 connectors J4 through to J7.
  - e. Disconnect the cables from RJ45 connectors J11 through to J14.
3. While supporting the P-CPIC-G card, remove the screws that hold the P-CPIC-G on its mounting pillars. Store the screws in a safe place for reuse.
4. Remove the P-CPIC-G card from its mounting pillars.

### 6.8.2 Installing and Configuring the Cable Power Injector I/O Card (P-CPIC-G)

Avoid locating the equipment near heat sources, in direct sunlight, and where it is exposed to high humidity or dust levels.

Before removing or installing the P-CPIC-G card, ensure that all AC and DC power supplies serving the cabinet are turned off and isolated.

**⚠ WARNING**

***AUTOMATIC EQUIPMENT WARNING: This equipment is part of an automated system. When installing or servicing this equipment or any other part of the warning system, you must be aware that the system could energize circuits and signals at any time. Use extreme caution to protect yourself from electric shock, loud sounds, and bright light that could be generated by the system. To avoid these hazards, always disconnect power to all of the system and its components, including battery backup power supplies when installing or servicing any part of the warning system.***

To install and configure the Cable Power Injector I/O card (P-CPIC-G):

1. Ensure that the AC or DC power supplies serving the P-CPIC-G card and all other connected equipment are turned off and isolated.
2. Place the P-CPIC-G card on to its housing mounting pillars and fasten to the pillars using the screws supplied or previously removed.

3. While referencing the cabinet wiring drawings and the Technical Installation Guide, connect the P-CPIC-G connectors to the system cables in the following manner.
  - a. Connect the cables to RJ45 connectors J11 through to J14.
  - b. Connect the cables to RJ45 connectors J4 through to J7.
  - c. Connect the cables to card header J3 and J10.
  - d. Connect the cables to RJ45 connectors J8 and J9.
  - e. Connect the cables to RJ45 connectors J1 and J2.

## 6.9 Amplifier Audio Distribution Cards (P-AADCx-G)

### 6.9.1 Removing the Amplifier Audio Distribution Card (P-AADCx-G)

To remove the Amplifier Audio Distribution card (P-AADCx-G):

1. Before removing or installing the P-AADCx-G card, ensure that all AC and DC power supplies serving the cabinet are turned off and isolated. This should remove any live voltages generated with the cabinet from the terminal blocks of the P-AADCx-G.
2. While referencing the rack wiring drawings, disconnect the P-AADCx-G connectors to the system cables in the following manner.
  - a. Disconnect the cables from card headers J1 through J4 as applicable.
  - b. Disconnect the Speaker Circuit wires from TB1 pins 1 through TB32.
3. While supporting the P-AADCx-G card, remove the screws that hold the P-AADCx-G card on its mounting pillars. Store the screws in a safe place for reuse.
4. Remove the P-AADCx-G card from its mounting pillars.

### 6.9.2 Installing and Configuring the Amplifier Audio Distribution Cards (P-AADCx-G)

Avoid locating the equipment near heat sources, in direct sunlight, and where it is exposed to high humidity or dust levels.

Before removing or installing the P-AADCx-G card, ensure that all AC and DC power supplies serving the cabinet are turned off and isolated.

**NOTE:** The x stands for P-AADC1-G, P-AADC2-G, P-AADC4-G, or P-AADC8-G.

#### **⚠ WARNING**

***AUTOMATIC EQUIPMENT WARNING: This equipment is part of an automated system. When installing or servicing this equipment or any other part of the warning system, you must be aware that the system could energize circuits and signals at any time. Use extreme caution to protect yourself from electric shock, loud sounds, and bright light that could be generated by the system. To avoid these hazards, always disconnect power to all of the system and its components, including battery backup power supplies when installing or servicing any part of the warning system.***

To install and configure the Amplifier Audio Distribution cards (P-AADCx-G):

1. Ensure that the AC or DC power supplies serving the P-AADCx-G card and all other connected equipment are turned off and isolated.
2. Place the P-AADCx-G card on to its housing mounting pillars and fasten to the pillars using the screws supplied or previously removed.
3. While referencing the cabinet wiring drawings and the Technical Installation Guide, connect the P-AADCx-G connectors to the system cables in the following manner.
  - a. Connect the speaker circuit wires from TB1 pins 1 through TB32.
  - b. Connect the cables from RJ45 connectors J1 through J4.

## 6.10 Fan Wiring Termination Card (P-FWTC-G)

### 6.10.1 Removing the Fan Wiring Termination Card (P-FWTC-G)

To remove the Fan Wiring Termination card (P-FWTC-G):

1. Before removing or installing the P-FWTC-G card, ensure that all AC and DC power supplies serving the cabinet are turned off and isolated. This should remove any live voltages generated with the cabinet from the terminal blocks of the P-FWTC-G card.
2. While referencing the rack wiring drawings, disconnect the P-FWTC-G connectors to the system fan wiring.
3. While supporting the P-FWTC-G card, remove the screws that hold the P-FWTC-G card on its mounting pillars. Store the screws in a safe place for reuse.
4. Remove the P-FWTC-G card from its mounting pillars.

### 6.10.2 Installing and Configuring the Fan Wiring Termination Card

Avoid locating the equipment near heat sources, in direct sunlight, and where it is exposed to high humidity or dust levels.

Before removing or installing the P-FWTC-G card, ensure that all AC and DC power supplies serving the cabinet are turned off and isolated.

#### **⚠ WARNING**

***AUTOMATIC EQUIPMENT WARNING: This equipment is part of an automated system. When installing or servicing this equipment or any other part of the warning system, you must be aware that the system could energize circuits and signals at any time. Use extreme caution to protect yourself from electric shock, loud sounds, and bright light that could be generated by the system. To avoid these hazards, always disconnect power to all of the system and its components, including battery backup power supplies when installing or servicing any part of the warning system.***

To install and configure the Fan Wiring Termination card (P-FWTC-G):

1. Ensure that the AC or DC power supplies serving the P-FWTC-G card and all other connected equipment are turned off and isolated.
2. Place the P-FWTC-G card onto its housing mounting pillars and fasten to the pillars using the screws supplied or previously removed.

3. While referencing the cabinet wiring drawings and the Technical Installation Guide, connect the P-FWTC-G connectors to the system fan wiring.

### 6.11 IS Barrier Board (P-IS-BARRIER-G)

#### 6.11.1 Removing the IS Barrier Board (P-IS-BARRIER-G)

To remove the IS Barrier Board (P-IS-BARRIER-G):

1. Before removing or installing the P-IS-BARRIER-G card, ensure that all AC and DC power supplies serving the cabinet are turned off and isolated. This should remove any live voltages generated with the cabinet from the terminal blocks of the P-IS-BARRIER-G.
2. Referencing the rack wiring drawings, disconnect the P-IS-BARRIER-G connectors to the Access Panel wiring.
3. While supporting the P-IS-BARRIER-G card, remove the screws that hold the P-IS-BARRIER-G on its mounting pillars. Store the screws in a safe place for reuse.
4. Remove the P-IS-BARRIER-G card from its mounting pillars.

#### 6.11.2 Installing and Configuring the IS Barrier Board

Avoid locating the equipment near heat sources, in direct sunlight, and where it is exposed to high humidity or dust levels.

Before removing or installing the P-IS-BARRIER-G card, ensure that all AC and DC power supplies serving the cabinet are turned off and isolated.

**⚠ WARNING**

***AUTOMATIC EQUIPMENT WARNING: This equipment is part of an automated system. When installing or servicing this equipment or any other part of the warning system, you must be aware that the system could energize circuits and signals at any time. Use extreme caution to protect yourself from electric shock, loud sounds, and bright light that could be generated by the system. To avoid these hazards, always disconnect power to all of the system and its components, including battery backup power supplies when installing or servicing any part of the warning system.***

To install and configure the IS Barrier board (P-IS-BARRIER-G):

1. Ensure that the AC or DC power supplies serving the P-IS-BARRIER-G card and all other connected equipment are turned off and isolated.
2. Place the P-IS-BARRIER-G card on to its housing mounting pillars and fasten to the pillars using the screws supplied or previously removed.
3. While referencing the cabinet wiring drawings and the Technical Installation Guide, connect the P-IS-BARRIER-G card connectors to the Access Panel wiring.

## 6.12 High Integrity I/O Board (P-NPLUS1-G)

### 6.12.1 Removing the High Integrity I/O Board (P-NPLUS1-G)

To remove the High Integrity I/O Board (P-NPLUS1-G):

1. Before removing or installing the P-NPLUS1-G card, ensure that all AC and DC power supplies serving the cabinet are turned off and isolated. This should remove any live voltages generated with the cabinet from the wiring of the P-NPLUS1-G.
2. Referencing the card wiring picture, disconnect the P-NPLUS1-G I/O BUS connectors from the MASTER<sub>n</sub>/STANDBY<sub>n</sub> ports.
3. While supporting the P-NPLUS1-G card, remove the screws that hold the P-NPLUS1-G on its mounting pillars. Store the screws in a safe place for reuse.
4. Remove the P-NPLUS1-G card from its mounting pillars.

### 6.12.2 Installing and Configuring the High Integrity I/O card

To install and configure the High Integrity I/O card (P-NPLUS1-G):

1. Before removing or installing the P-NPLUS1-G card, ensure that all AC and DC power supplies serving the cabinet are turned off and isolated.
2. Place the P-NPLUS1-G card on to its housing mounting pillars and fasten to the pillars using the screws supplied or previously removed.
3. While referencing the card wiring picture, connect the P-NPLUS1-G connectors to the system cables in the following manner.

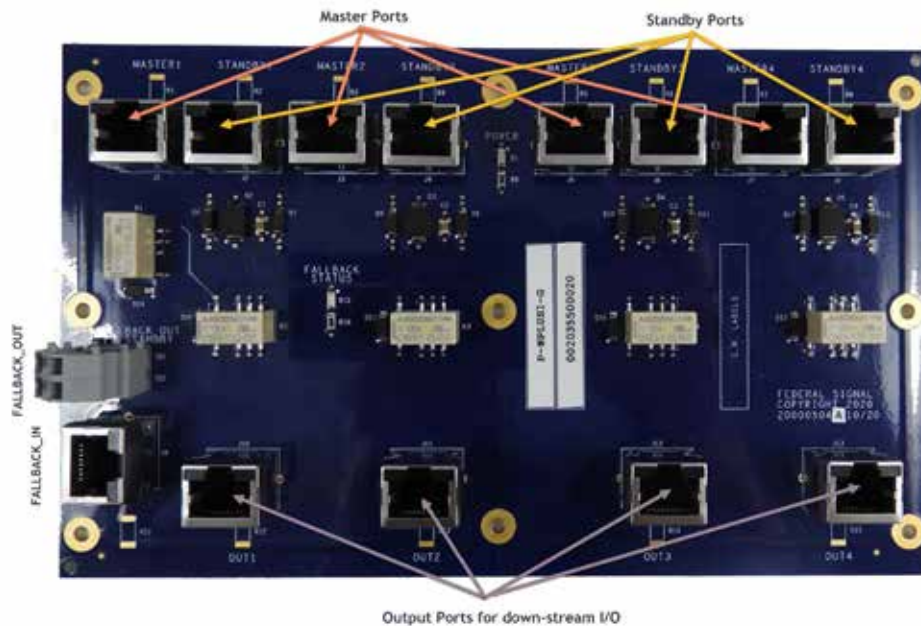

- a. Wire I/O bus cable(s) from a-side controller to MASTER<sub>n</sub> ports.
- b. Wire I/O bus cable(s) from b-side controller to STANDBY<sub>n</sub> ports, grouping with the respective bus from a-side.
- c. Wire the OUT<sub>n</sub> port to the down-stream I/O cards to be shared.
- d. Wire the Fault Relay output from a-side controller to the FALLBACK\_IN port.

## Installing and Configuring the I/O Cards

- e. Wire the FALLBACK\_OUT terminal blocks to an input on b-side (for example, AUX\_IN for GEN II or built-in digital inputs for Remote Controller).
- f. Configure the I/O cards as normal, selecting shared scope.
- g. Configure the I/O card channel on the b-side as input\_channel\_fallback. See below.

The screenshot displays a configuration window for an I/O card channel. The 'Channel ID' is set to 1 and the 'Scope' is 'B-Side'. The 'Name' and 'Comments' fields both contain 'Virtual Input Channel 1'. Under the 'Settings' section, 'Series' is 'Normally Open/NOE', 'Mode' is 'Direct', and 'Contact Type' is 'Dry / Volt-Free Contact'. Timing parameters include 'Hysteresis Time (Seconds)' at 0, 'Minimum Active Time (Seconds)' at 0, and 'Maximum Active Time (Seconds)' at 2. The 'Visibility' section has 'Show STATE in Event Log' and 'Show STATE in System Activity' checked. In the 'Input Function' section, the 'Function' dropdown is set to 'input\_channel\_fallback', which is circled in red. Below this are sections for 'Parameters' (with a warning icon and 'No parameters for this function.'), 'Connection Inputs', and 'Action Buttons' (Enable, Detach, Inhibit). A table at the bottom has columns for Type, Name, Channel Name, Signal, and Source ID.

### **⚠ WARNING**

***AUTOMATIC EQUIPMENT WARNING: This equipment is part of an automated system. When installing or servicing this equipment or any other part of the warning system, you must be aware that the system could energize circuits and signals at any time. Use extreme caution to protect yourself from electric shock, loud sounds, and bright light that could be generated by the system. To avoid these hazards, always disconnect power to all of the system and its components, including battery backup power supplies when installing or servicing any part of the warning system.***



## 7.0 PAGASYS GEN II Controller Firmware

The PAGASYS GEN II system uses the System Manager software to configure and manage the system operation; however, the System Controller is the central point of control for Public Address and General Alarm operations:

- The System Controller manages all system I/O, selects and routes audio to system amplifiers, and manages communications within the PAGASYS system.
- If the System Manager stops communicating, the PAGASYS GEN II controller will continue to operate normally.

### 7.1 Updating PAGASYS GEN II Controller

When updating the System Manager software, it is important to maintain controller firmware compatibility for the following reasons:

- Database fields may have changed since the initial release of the product.
- Messaging between the System Manager and the controller may have changed.
- Features may have been added.
- Improvements for issues discovered during testing and deployment of customer systems.

### 7.2 Upgrading the Controller Firmware

Perform the following procedure when the controller needs an update to match the System Manager's version.

To update the controller firmware using the automated installer, you need the following:

- Laptop or server with a serial port connection (or USB to serial cable). If your computer does not have a serial port, you will need a USB-to-serial adapter.
- SD card
- SD card reader
- Serial cable
- Terminal emulator software (preferably PuTTY)
- Copy of the controller firmware files with installation script.

To update the controller firmware using the automated installer:

1. Connect the serial port cable to the controller shelf using the TEST port DB-9 connector on the front of the controller shelf.
2. To access the TEST port, remove the plastic front cover from the shelf by pressing the tab on the far right of the cover to the left while pulling.

Figure 54 Back of Controller Shelf

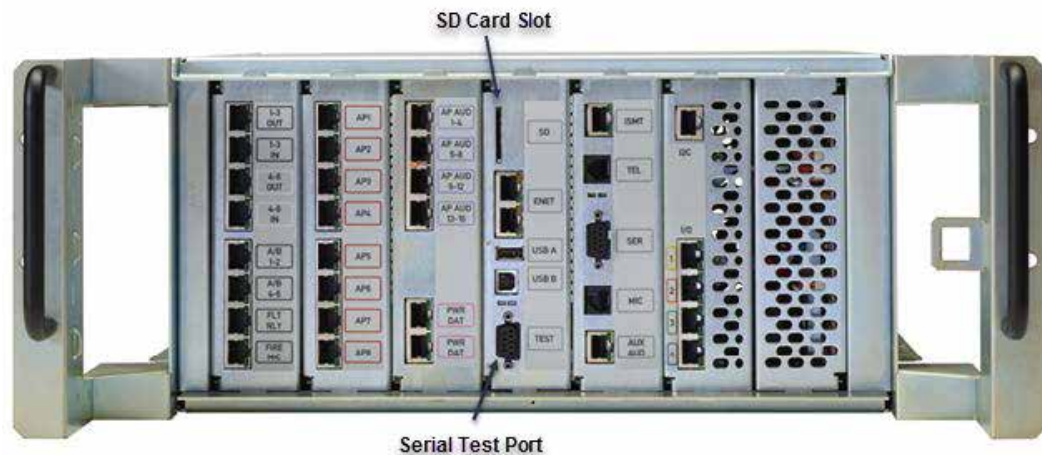

3. To upgrade the controller software, execute a command that upgrades the controller using the serial port address connected to the controller test port. To find out which port is being used by the server, either check the device manager for the port marked as “USB to serial bridge” or use the terminal emulator software to evaluate which port is being used by the system.
4. To find the USB to serial bridge port, access the device manager and view the ports for one marked as USB to serial bridge. See the example below.

Figure 55 View the Ports

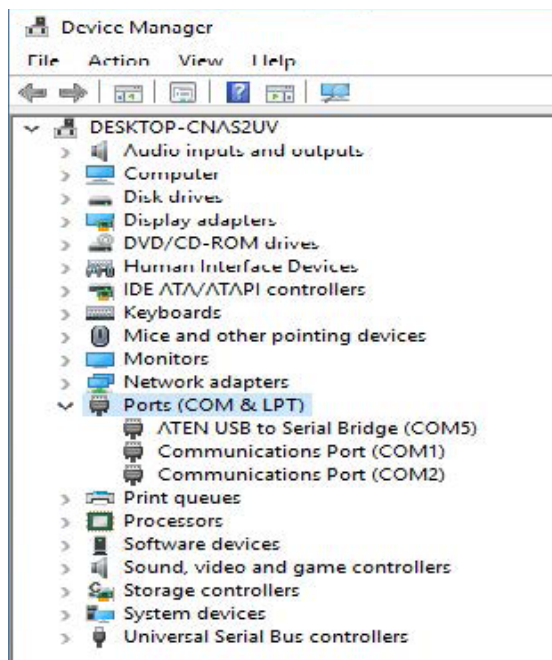

5. To use the emulator software to find the serial port connected to the controller, start the terminal software. The terminal emulator software needs to be configured as serial 115200 baud-rate, 8 data bits, no parity bits, and 1 stop bit. See Figure 56.
6. Change serial ports in the emulation software, COM1, COM2, etc., until the port is found that responds with the Pagasys prompt.

- Once the COM port connected to the controller is known, save the configuration as PAGASYS Controller, exit the terminal emulator software, and continue the upgrade.

Figure 56 PuTTY Example

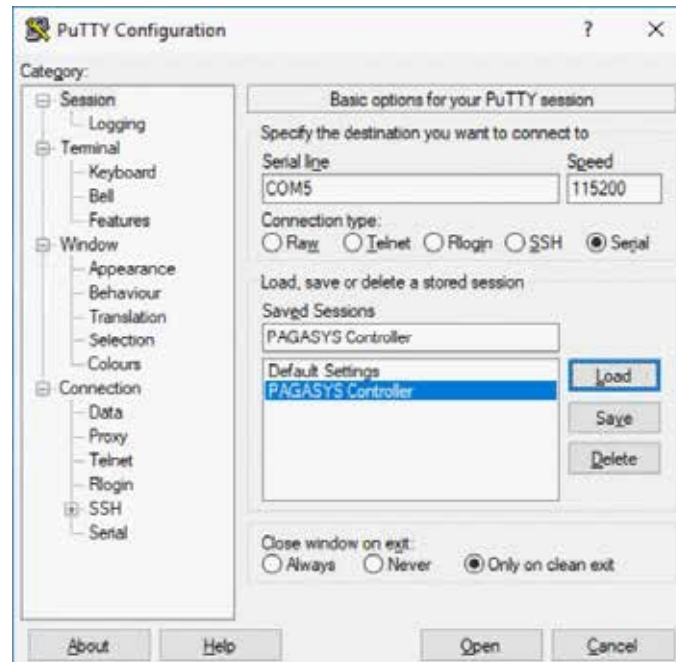

- Once you have the computer connected to the controller and know which serial port connects to the controller, copy the controller firmware folder to the desktop of the host computer.
- Open the firmware folder on the host computer.

Figure 57 Open the Firmware Folder

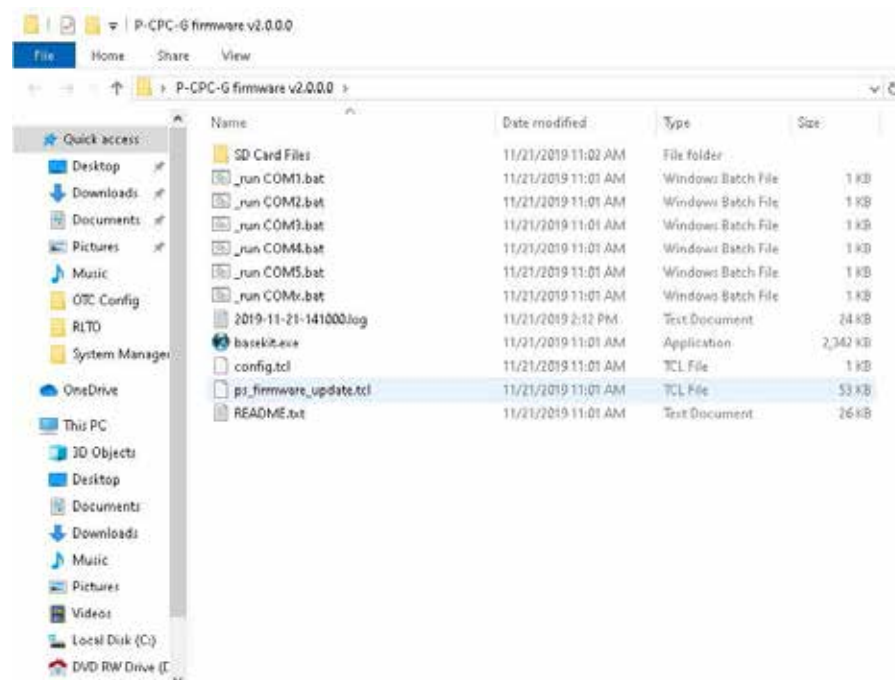

- Using the computer and a local SD card reader, place all the controller binary and CRC files in the root directory of the SD card.

**Figure 58 Place all Controller Binary and CRC Files in Root Directory**

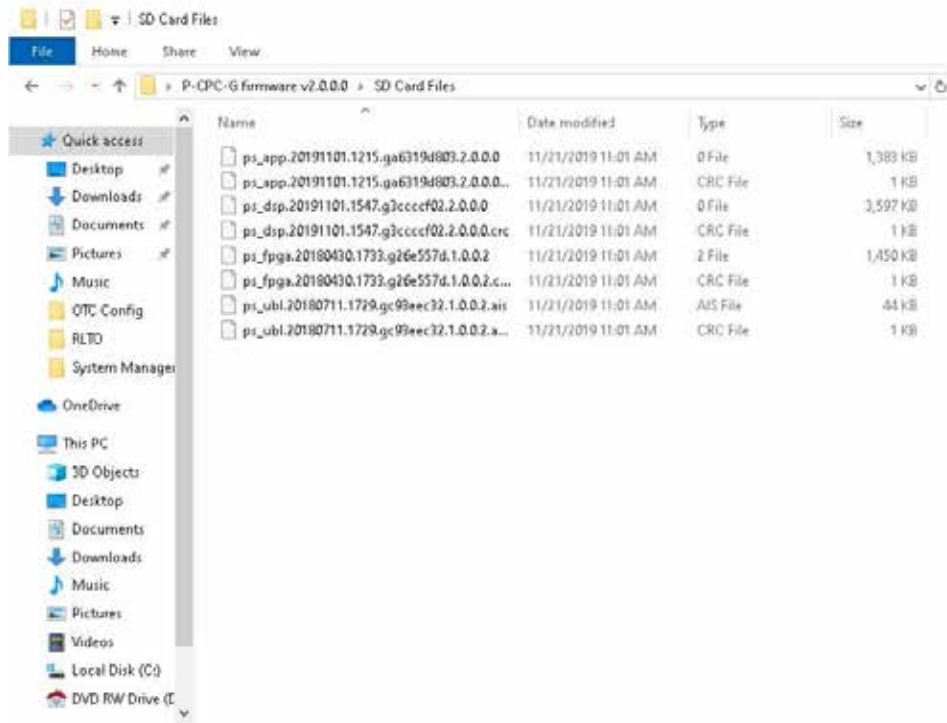

- To initiate the upgrade, insert the SD card into the controller shelf SD card slot.
- Open a Windows® Explorer application and select the desktop folder that contains the installation files.
- Double-click on one of the “\_run COM” batch files directly in the File Explorer window. For example, if you have identified the port as COM2, double-click on “\_run COM2.bat,” and it opens a Command Prompt window and starts running the installation.

Figure 59 Run the Install Application

```

Command Prompt
11/21/2019 11:03 AM <DIR> System Manager Versions
                    5 File(s) 342,100,863 bytes
                    8 Dir(s) 436,330,577,920 bytes free

C:\Users\admin\Desktop>cd P-CPC-G firmware v2.0.0.0

C:\Users\admin\Desktop\P-CPC-G firmware v2.0.0.0>dir
Volume in drive C has no label.
Volume Serial Number is 2CE9-ADD0

Directory of C:\Users\admin\Desktop\P-CPC-G firmware v2.0.0.0

11/21/2019 02:10 PM <DIR> .
11/21/2019 02:10 PM <DIR> ..
11/21/2019 02:12 PM                23,957 2019-11-21-141000.log
11/21/2019 11:01 AM            2,397,942 basekit.exe
11/21/2019 11:01 AM                301 config.tcl
11/21/2019 11:01 AM            53,323 ps_firmware_update.tcl
11/21/2019 11:01 AM            26,364 README.txt
11/21/2019 11:02 AM <DIR> SD Card Files
11/21/2019 11:01 AM                55 _run COM1.bat
11/21/2019 11:01 AM                55 _run COM2.bat
11/21/2019 11:01 AM                55 _run COM3.bat
11/21/2019 11:01 AM                55 _run COM4.bat
11/21/2019 11:01 AM                55 _run COM5.bat
11/21/2019 11:01 AM                50 _run COMx.bat
                    11 File(s) 2,502,212 bytes
                    3 Dir(s) 436,330,577,920 bytes free

C:\Users\admin\Desktop\P-CPC-G firmware v2.0.0.0>basekit ps firmware update.tcl

```

14. After entering the command, the application should execute to completion, ending with the message to restart the controller. If you see a different message, note the message that displays and contact Federal Signal Support.

**IMPORTANT:** Do not power down the controller, as there is a chance that the controller will be left unusable, and a much more difficult recovery procedure will be needed.

Figure 60 Message Now reboot the controller

```

Command Prompt
calculating NOR CRC: 87%
calculating NOR CRC: 90%
calculating NOR CRC: 93%
calculating NOR CRC: 96%
calculating NOR CRC: 99%
calculating NOR CRC: 100%
NOR CRC updated
Installing DSP firmware...
copied DSP binary to sata
copied DSP CRC file to sata
copied DSP binary to nand
copied DSP CRC file to nand
Installing FPGA firmware...
copied FPGA binary to sata
copied FPGA CRC file to sata
copied FPGA binary to nand
copied FPGA CRC file to nand
Collecting obsolete files...
Removing obsolete files...
Restore config CRC file...
restored
Unmount SD card
SD card unmounted

--==< Update successful! >===

Now reboot the controller.

C:\Users\admin\Desktop\P-CPC-G firmware v2.0.0.0>
    
```

15. After you receive the upgrade Success message, reboot the controller firmware. This can be done by powering off the controller and powering back up from the power panel under the server in the rack.
16. Wait for the firmware to finish rebooting, indicated by the message “NOTICE All memory allocation is now locked” on the script execution window.
17. After the successful reboot, the controller firmware upgrade is complete.

Figure 61 Firmware Upgrade is Complete

```

COM3 - PuTTY
fallback operating"
2019-11-22T12:41:41.000-07:00 NOTICE Fault pilot_tone_fail cleared on "local_rack_audio" 00.0
2019-11-22T12:41:41.000-07:00 WARNING Watchdog Margin reduced to 29s for "PCP Refresh Config 4"
PAGASYS>
2019-11-22T12:41:42.000-07:00 WARNING Watchdog Margin reduced to 27s for "Widget Timers"
2019-11-22T12:41:42.000-07:00 WARNING Watchdog Margin reduced to 29s for "PCP Refresh Config 2"
2019-11-22T12:41:42.000-07:00 WARNING Watchdog Margin reduced to 29s for "PCP Slave Ping 2"
PAGASYS>
2019-11-22T12:41:43.000-07:00 WARNING Watchdog Margin reduced to 29s for "PCP Refresh Config Amps"
PAGASYS>
2019-11-22T12:41:44.000-07:00 WARNING Watchdog Margin reduced to 296s for "Monitor Files Integrity"
PAGASYS>
2019-11-22T12:41:46.000-07:00 NOTICE All memory allocation is now locked
PAGASYS>
2019-11-22T12:41:47.000-07:00 WARNING Watchdog Margin reduced to 298s for "Controller Faults"
PAGASYS>
    
```

**NOTE:** There is a README file in the firmware folder that gives detailed instructions on the installation and the recovery procedures.

## 8.0 Controller Chassis Operations

### 8.1 Configuration

Standard Controller Chassis configuration is included in the PAGASYS GEN II System Manager User Manual.

### 8.2 Controller Card Real-Time Clock Maintenance

The Controller card includes a 3 V Lithium CR16xx coin battery cell, which supports the processor card real-time clock when power is removed from the Controller Chassis.

Lithium CR batteries have a long shelf life since they have a low self-discharge rate, so a controller card can be in storage for a significant amount of time with the Mylar® tab inserted between the battery and the battery cell holder contacts, and the battery will still be usable. Follow manufacturer recommendations regarding the shelf life of the battery. If manufacturer recommendations are not available, replace the battery if stored for more than two years.

To enable the battery for operation: The Mylar tab should be extending out of the controller PCB SD card port; pull this Mylar tab to enable the coin battery on the controller PCB. Once the Mylar tab is removed, the real-time clock should maintain the date/time value when system power is removed from the Controller card. (Set the system date and time initially after installing the controller card.)

During regular maintenance of the system, replace the controller card lithium CR battery cell if it has been in use for more than two years and the card has been removed from power for any significant amount of time during that period. If the PAGASYS GEN II System Manager reports that the controller battery cell needs to be replaced, or if the date/time resets when power is removed from the controller card, replace the battery cell.

### 8.3 Replacing the Controller Card Lithium CR Battery

To replace the controller card lithium CR battery:

1. Use the instructions in “5.0 Removing and Installing the Controller Chassis” on page 62 to remove the controller card from the Controller Chassis.
2. Remove the Lithium CR battery cell from the battery holder.
3. Insert a new Lithium CR battery cell into the holder.
4. Use the instructions in “5.0 Removing and Installing the Controller Chassis” on page 62 to reinstall the controller card in the Controller Chassis and bring the Controller Chassis back into service.
5. Reset the system date and time after reinstalling the Controller Chassis.

## 9.0 Configuring the Amplifier Chassis

To configure the Amplifier Chassis:

- The four amplifier cards have to be of uniform type: either DC or AC models. Each module has a separate power fuse.
- Each Amplifier Chassis needs to have its address set using the mini DIP switches, which are visible on the back of the Amplifier Chassis. Set the switches to reflect the desired amplifier number in the PAGASYS GEN II System Manager Software.

### 9.1 Setting the DIP Switches

Set the DIP switches using a reverse binary logic, with the switch in an up position representing 0, and in a down position representing 1.

For example,

- For amplifier 1, set the DIP switches to down-up-up-up-up to represent 10000.
- For amplifier 2, set the DIP switches to up-down-up-up-up to represent 01000, and so on.
- Number the amplifiers starting at one in the cabinet bottom amplifier position and then increasing by one moving up.
- In a 4 kW system, set the amplifier DIP switches for the amplifier at the top of the cabinet to up-up-down-up-up to represent 00100 (represents amplifier four). See the figure below.

**Figure 62 Setting Mini DIP Switches**



- Amplifier Chassis housed in an auxiliary cabinet should have DIP switches continue numbering from the Amplifier Chassis in the connected controller cabinet.
- Jumpers on the Amplifier Signal Backplane do not function as fuses but are connections to configure the chassis to have a Standby Amplifier. If ISMT support is needed in the Amplifier Chassis, you must remove all four jumpers to avoid damaging the ISMT card.



- You can designate an Amplifier Card as a Standby Amplifier. Install the Standby Amplifier in physical slot 4 of an Amplifier Chassis.
- Each module/card can communicate with a System Controller through two RS485 communication channels for redundancy. In the absence of a System Controller, the amplifier defaults to a standalone operation.
- Each amplifier card may be configured to a different audio input channel, or they can share channels.
- Each amplifier card has a separate output wire pair within the output cable, but two output pairs can be externally bridged to produce a 600 W output.
- Each amplifier card has a Standby relay, which can reroute its output speakers to a standby Bus. This relay is powered and controlled by the adjacent amplifier card so that a faulty amplifier card can be rerouted.
- Each amplifier card has its own indicator LED lights and a power button.

## 9.2 Powering up/Powering down

To power up the Amplifier Chassis:

- The amplifier (all four cards [modules]) powers up automatically upon connection of power.

To power down the Amplifier Chassis:

- Power down an amplifier card by pressing the power button and holding it for three seconds. Another half-second press of the power button restores the power.
- You can put an amplifier card, or the whole amplifier, to sleep by a system command. This condition stops the output bridge from working and puts the amplifier into a low-current consumption mode.

## 9.3 Normal Operations

The amplifier card has a self-test capability that checks its own performance.

LEDs	Description
Green NORMAL LED	Indicates all parameters are normal.
Yellow LED lights	Failures are reported by communications channels.
Green NORMAL LED, steady on	Indicates that the amplifier card is capable of delivering audio output power. Blinking LED indicates that the card is capable of delivering output, but a self-diagnostic detected a value out of calibration, such as a mild overload or load impedance out of calibration.
NORMAL LED turning off	Indicates a severe abnormality.
Nine green dB LEDs	Show the level of output, as referenced to 100 V <sub>RMS</sub> . A line-level audio signal input must be connected to the selected input channel.

LEDs	Description
Blue SELECTED LED	Indicates that the output of an amplifier card is connected to the output header. Connect the speaker system/load to the 100 V <sub>RMS</sub> line connections.

### 9.4 Standby Amplifier Operations and Routing

In a PAGASYS GEN II system, amplifier-module redundancy should be provided by the use of Standby Amplifiers. A Standby Amplifier can provide redundancy for an Amplifier Chassis or for any Amplifier Chassis that is connected to the chassis containing the Standby Amplifier by connecting the chassis using a standby cable. If a Standby Amplifier is needed, the Standby Amplifier must be positioned in slot four of the Standby Amplifier Chassis, and the jumpers on the Amplifier Signal Backplane for this chassis must be configured to standby chassis configuration. See Figure 51 for a view of the jumpers configured to support the Standby Amplifier. If a chassis is not going to support a Standby Amplifier, or the chassis is being configured to support ISMT, the jumpers should be removed from the Amplifier Signal Backplane.

**Figure 63 Jumpers configured to support a Standby Amplifier**

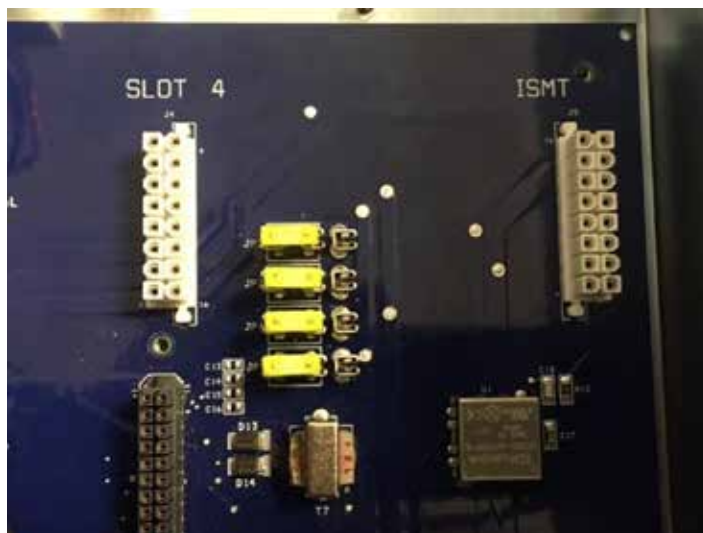

## 9.5 Test Features

### Test Tone

Use a 20 kHz test tone to check the integrity of the audio system connections. The System Controller may generate this tone to test the connection from the audio source to each of the amplifier inputs. The tone may be generated by the amplifier card itself to test the impedance of the load speakers. The tone may be generated by the optional ISMT card.

### Impedance Calibration

Use the impedance calibration procedure to capture and store the impedance of speakers connected to an amplifier card when the ISMT card is not used. Ensure that the system is not transmitting audio signals prior to initiating the procedure. Initiate impedance testing on the amplifier from the System Manager in the amplifier Field Diagnostics menu. The amplifier card generates a test tone and measures its speaker impedance, and then stores the result as a new calibrated value.

**NOTE:** Only do calibrations when it has been verified that all speakers are working without faults and all the tapping adjustments are completed. Any change of the loudspeaker circuit requires recalibration.

### Automatic Testing of Impedance

Each amplifier card periodically tests the impedance of its speakers and compares the result with the stored calibrated value. All impedance tests are initiated by the System Controller. If the result is out of tolerance, a load fault is reported on the RS485 communication line, and a yellow LOAD FAULT LED turns on.

### Earth Fault Detection System

Audio output lines are isolated from the earth ground. Earth fault detection system continuously checks for current leaks and reports a failure to the System Controller when out of tolerance. A LOAD FAULT LED also turns on.

### Automatic Monitoring Temperature

Each amplifier card monitors its own temperature and reports to the System Controller. It turns on its fan when necessary and monitors the fan operation. If the temperature exceeds 80°C, HIGH TEMPERATURE LED turns on. If the temperature continues to rise, the amplifier card may shut down.

### Cut-out Condition

A cut-out condition, indicated by a yellow CUT OUT LED, means that the Class D amplifier bridge is disabled. It occurs at every power up during a normal initial ramp up; however, a severe overload or other malfunction may extend this condition beyond the initial ramp up. The condition is reported to the System Controller. The module attempts to restart the bridge every few seconds.

### 9.6 ISMT Operations (Optional)

Intelligent Speaker Monitoring and Tapping (ISMT) requires special ISMT-capable speakers and a P-ISMT-G card in the Amplifier Chassis.

Remove the four jumpers on the right side of the front motherboard of the chassis containing the ISMT card. Jumpers in all other shelves must be either on the right side or removed altogether.

One ISMT card supports not only all four amplifier cards of its own chassis, but also all other chassis sharing the standby cable connections.

It is a method of monitoring remote speaker status, using special communication commands sent over the speaker lines. Through this communication link, you can instruct each ISMT loudspeaker to change its tapping, recalibrate itself, and return status information back to the ISMT card.

The ISMT card performs the monitoring procedure when amplifier cards are idle and the system has allocated the time for the procedure.

During that time, the ISMT card provides 24 Vdc power over the speaker lines for the speaker monitoring circuits.

In one part of the procedure, a 20 kHz test tone is generated by the ISMT card, while each ISMT speaker measures the current through its speaker coil.

## 10.0 Setting up a Standby Amplifier

### 10.1 Defining an Amplifier Chassis 1 as the Standby Amplifier

Amplifier Chassis are numbered from bottom to top in a control cabinet. Auxiliary Cabinets are numbered from one to five. The PAGASYS GEN II system allows one amplifier card in an amplifier group to be the Standby Amplifier, and any Amplifier Chassis in the system can contain the Standby Amplifier.

- Any Amplifier Chassis in the system can contain the Standby Amplifier
- The Amplifier Chassis containing the Standby Amplifier must be configured as the Standby Amplifier Chassis in the System Manager software application
- The Standby Amplifier must be in the fourth amplifier slot in the Standby Amplifier Chassis
- All Amplifier Chassis that use the Standby Amplifier must be interconnected through the standby amp bus ports on the Amplifier Chassis
- The Standby Amplifier is configured using the System Manager software application

**Figure 64 Defining an Amplifier Chassis**

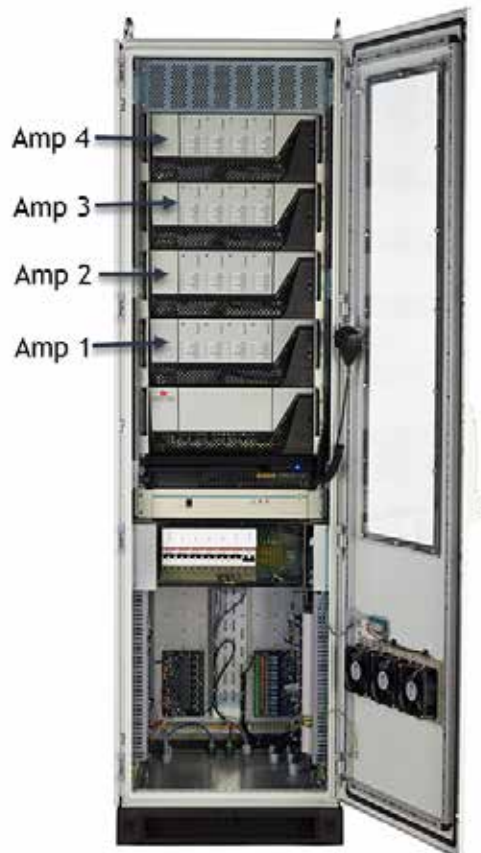

## Setting up a Standby Amplifier

---

To define an Amplifier Chassis 1 as the Standby Amplifier:

1. Remove the Standby Amplifier Chassis from the cabinet by removing the chassis mounting screws (that is, two sets of screws, left and right).

**Figure 65 Removing the chassis mounting screws**



2. Remove the (12) screws holding the cover on the chassis (that is, four each, left, right, and back) and remove the cover.

**Figure 66 Removing the cover screws**



- 3. Configure the Standby Amplifier Chassis by inserting the four jumpers on the signal mother board in the left-most position.

**NOTE:** Do not place the jumpers in the left-most position if the Amplifier Chassis is populated with an ISMT card.

Figure 67 Inserting four jumpers in the left-most position

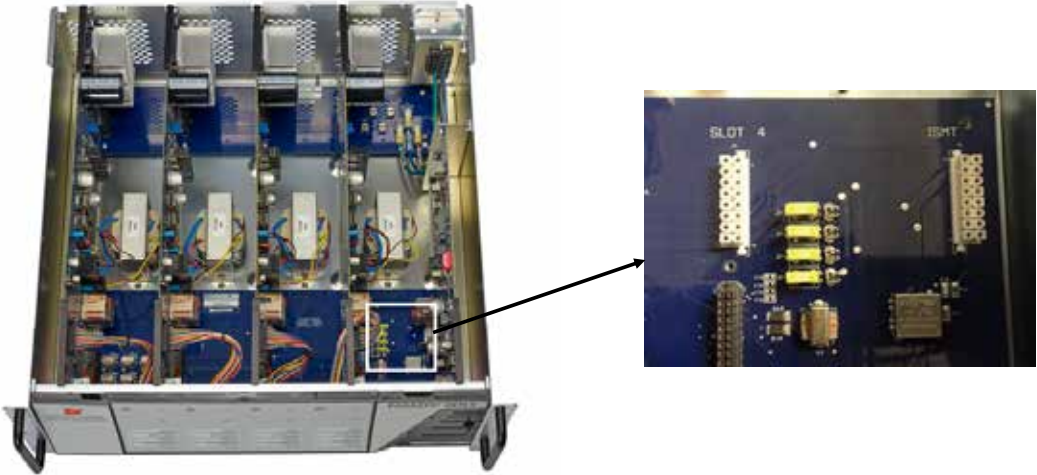

- 4. The Standby Amplifier must be in the fourth amplifier slot in the Standby Amplifier Chassis.

Figure 68 Fourth amplifier slot

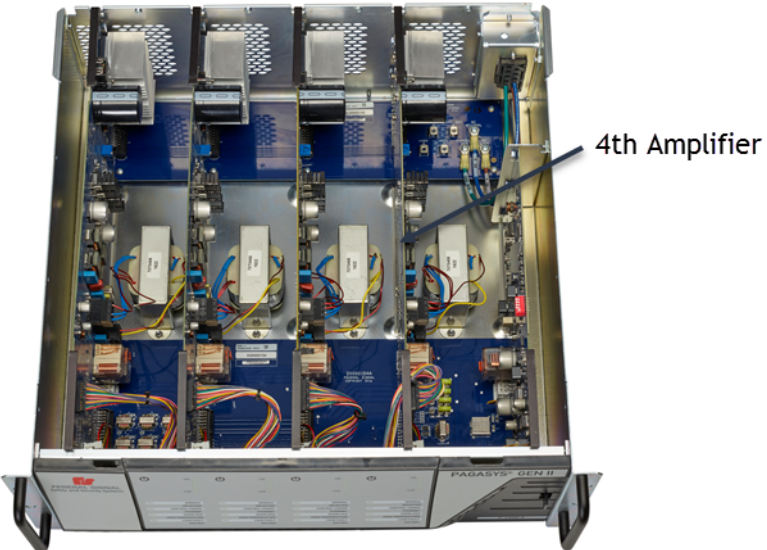

## Setting up a Standby Amplifier

- Interconnect all Amplifier Chassis that use the Standby Amplifier through the standby amp bus ports on the Amplifier Chassis.

**Figure 69 Standby amp bus ports on the Amplifier Chassis**



- Configure the Standby Amplifier using the System Manager software application.
  - Select Configuration > Equipment
  - From the list, scroll to Amplifiers and select the fourth slot of the Standby Amplifier Chassis
  - From the Options section, in the Monitoring list, click None.
  - From the Options section, in the Zone Standby list, click Standby (no zone)

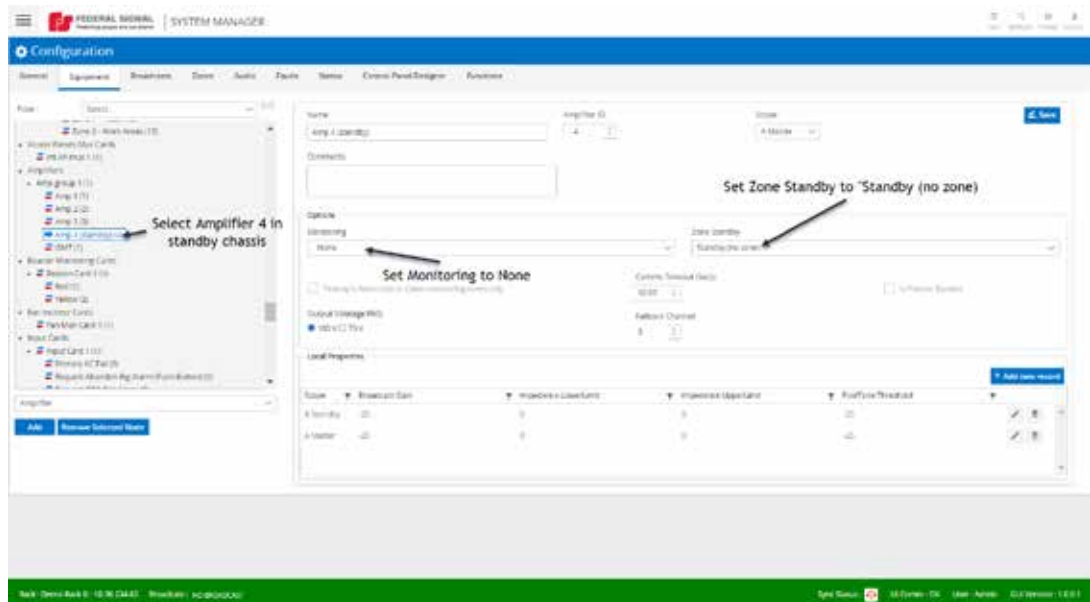



## 11.0 Terminating Speakers to MDF

### 11.1 Terminating a speaker to Amplifier Chassis 1, Amplifier 1

The PAGASYS GEN II system comes standard with one amplified audio distribution card, P-AADC2-G, for each Amplifier Chassis in the cabinet. With a four Amplifier Chassis system, four P-AADC2-G cards are provided.

The amplifier output signal is wired to the P-AADC2-G card using an amplifier audio out cable assembly that terminates on the P-AADC2-G card 8-pin connector receptacles (two per card). The speakers are terminated on the spring terminal block connectors on these cards. Each card supports up to two speaker loop circuits per amplifier PCB in the chassis.

In the following drawing, Amplifier Chassis 1 is already terminated to the 8-pin connectors on the amplified audio distribution card in slot 1 on the audio (left) panel assembly in the MDF area.

**Figure 70 Left (Audio) MDF Panel**

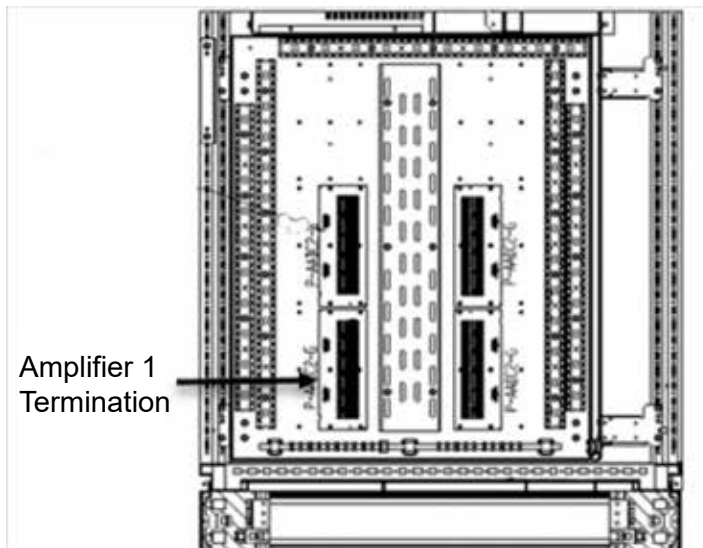

To terminate speakers to MDF:

- On the target amplified audio distribution card, terminate the +/- speaker wires to the primary Amp A forward + (F+) and forward – (F-) spring terminal block.
- If a speaker loop is needed, connect the return speaker wire to the reverse + (R+) and reverse – (R-) spring terminal block.
- This version of the amplifier audio distribution card (P-AADC2-G) allows the amplifier to be connected to up to two speaker runs. If a second speaker run is needed, wire the second speaker wire set to the secondary set of terminal blocks.

Figure 71 Target amplified audio distribution card (Amp A)

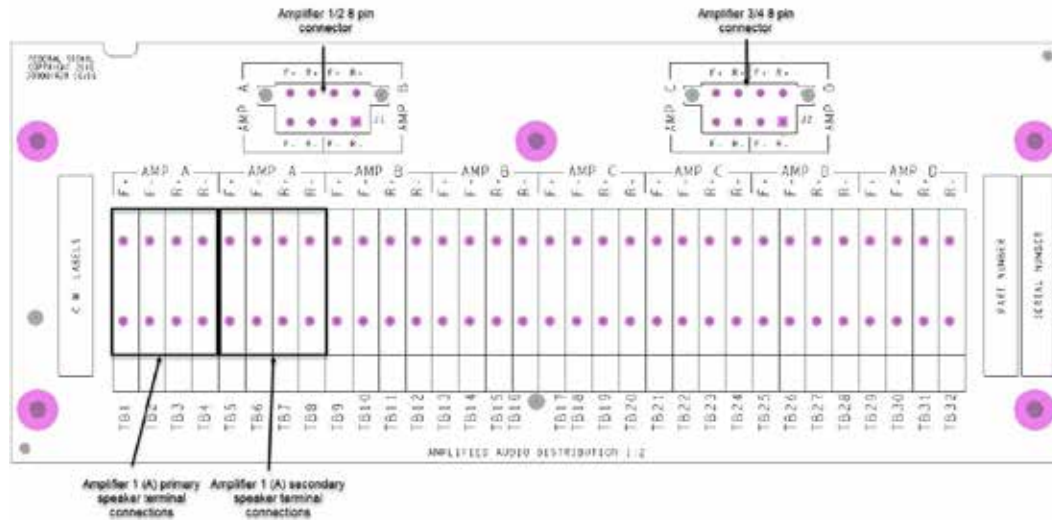

## 11.2 Terminating a speaker to Amplifier Chassis 2, Amplifier 2

Assuming the use of a standard amplified audio distribution card, P-AADC2-G, with spring terminal block connectors for speakers.

Amplifier Chassis 2 will already be terminated to the 8-pin connector on the amplified audio distribution card in slot 2 on the audio (left) panel assembly in the MDF area.

Figure 72 Amplifier 2 Termination

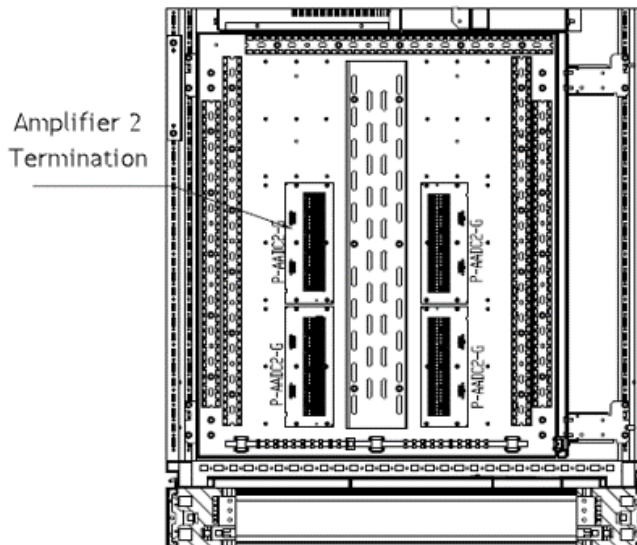

To terminate a speaker to Amplifier Chassis 2, amplifier 2:

- On the target amplified audio distribution card, terminate the +/- speaker wires to the primary Amp B forward + (F+) and the forward – (F-) spring terminal block.
- If a speaker loop is needed, connect the return speaker wire to reverse + (R+) and reverse – (R-) spring terminal block.

- This version of the amplifier audio distribution card (P-AADC2-G) allows the amplifier to be connected to up to two speaker runs. If a second speaker run is needed, wire the second speaker wire set to the secondary set of terminal blocks

Figure 73 Target amplified audio distribution card

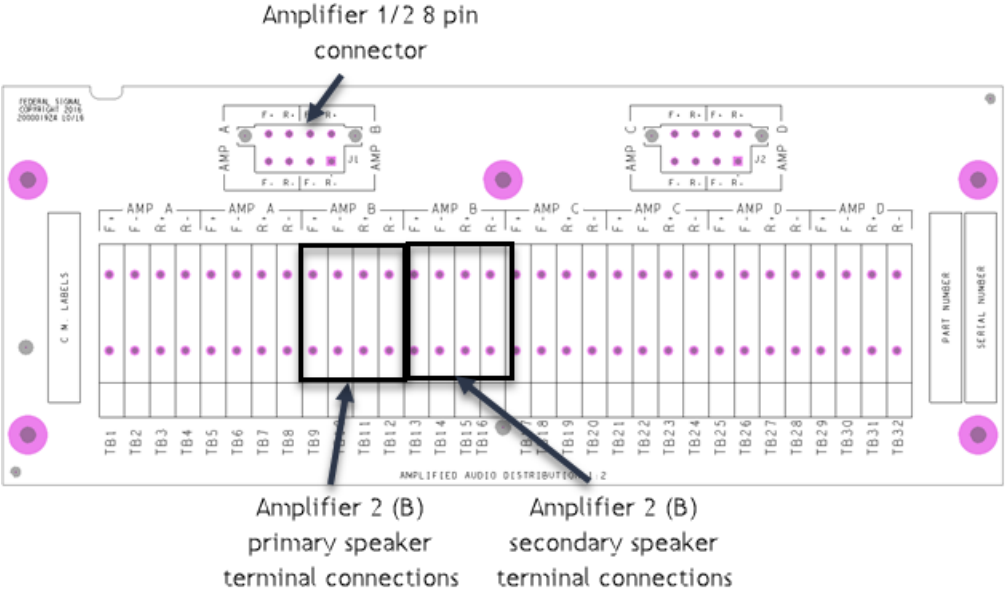

## 12.0 Terminating ISMT Speakers to MDF

### 12.1 Terminate an ISMT speaker to Amplifier Chassis 1, Amplifier 2

- Amplifier Chassis 1 should already be terminated to the 8-pin connector on the amplified audio distribution card in slot 1 on the audio (left) panel assembly in the MDF area.

Figure 74 Left (Audio) MDF Panel

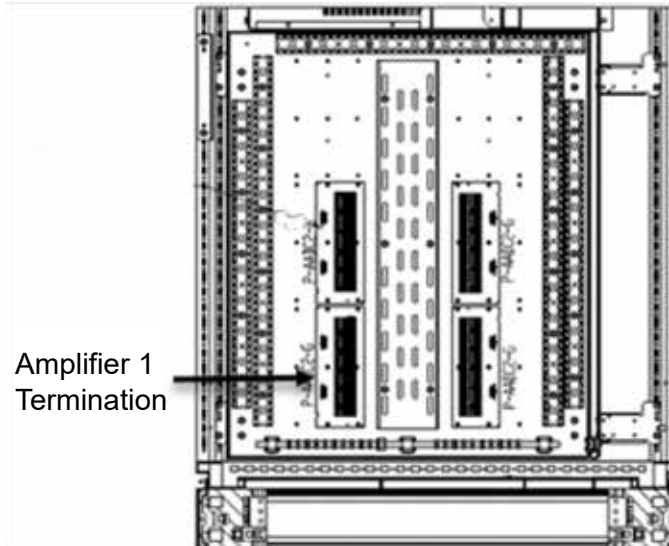

- Using a standard amplified audio distribution card, P-AADC2-G, with spring terminal block connectors for speakers
- Amplifier Chassis 1 is set up with an ISMT card installed
- Amplifiers are installed in all four slots

Figure 75 Amplifiers 2 and 4 are part of this ISMT configuration

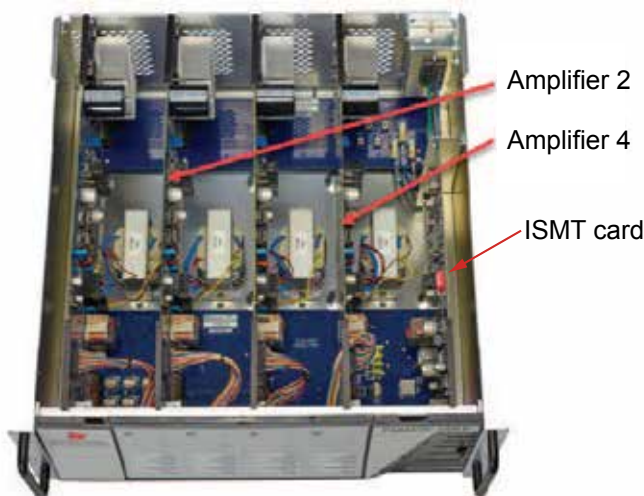

To terminate an ISMT speaker to Amplifier Chassis 1, Amplifier 2:

1. Configure the ISMT Amplifier Chassis by inserting the four jumpers on the signal motherboard in the right-most position, or remove the jumpers from the chassis.

**NOTE:** Do not place the jumpers in the left-most position if the Amplifier Chassis is populated with an ISMT card.

Figure 76 Inserting four jumpers in the right-most position

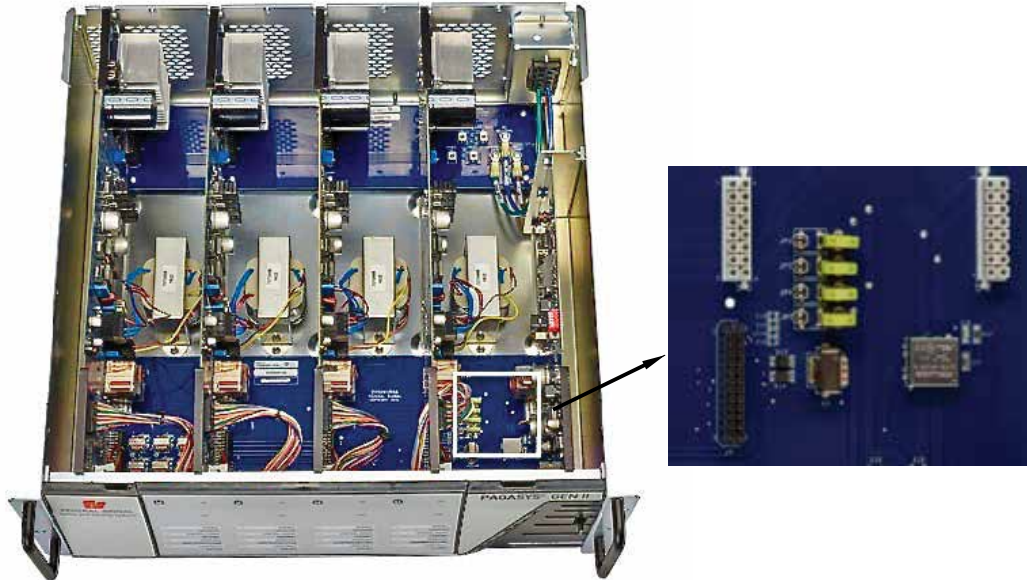
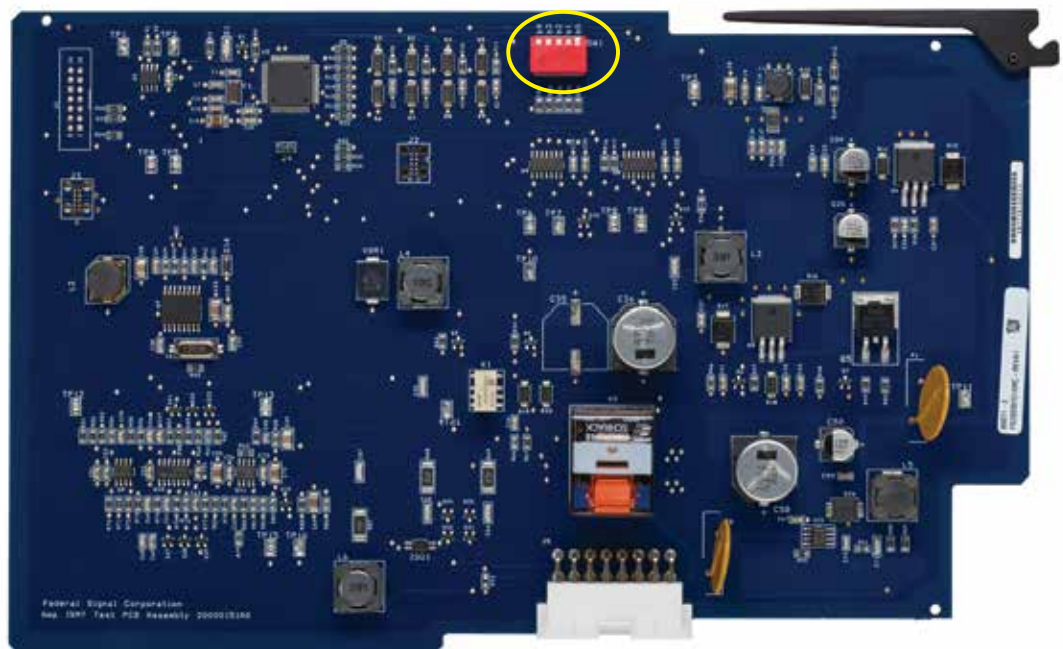

Figure 77 ISMT Card (P-ISMT-G)

ISMT card DIP switches



## Terminating ISMT Speakers to MDF

2. Set the ISMT card DIP switches to match the DIP switch settings on its Amplifier Chassis.
3. Insert the ISMT card in the slot on the far right side of the Amplifier Chassis.
4. Configure the Standby Amplifier using the System Manager software application.
  - a. Select Configuration > Equipment.
  - b. From the list, scroll to Amplifiers and select the amplifier in the second slot of Amp Chassis 1.
  - c. From the Options section, in the Monitoring list, click ISMT Spur Monitoring (or ISMT Loop Monitoring, if the ISMT speaker is being wired as loop).
  - d. From the Options section, in the Zone Standby list, click the desired zone

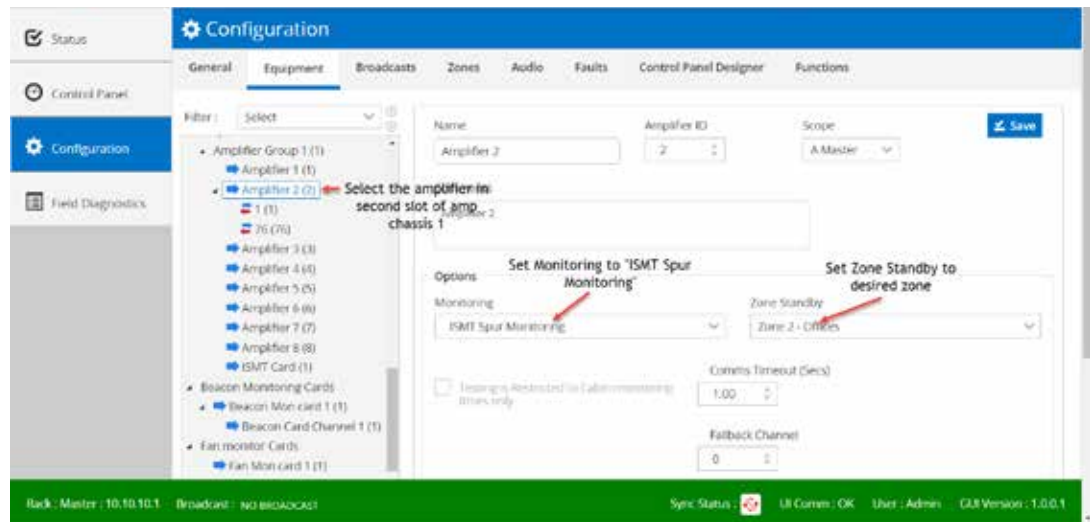

To terminate an ISMT speaker to Amplifier Chassis 1, Amplifier 2:

- On the target amplified audio distribution card, terminate the +/- speaker wires to the primary Amp B forward + (F+) and the forward – (F-) spring terminal block. (Ensure wires are terminated correctly, as an ISMT speaker will not communicate when wires are crossed.)
- If a speaker loop is needed, connect the return speaker wire to the reverse + (R+) and reverse – (R-) spring terminal block.
- This version of the amplifier audio distribution card (P-AADC2-G) allows the amplifier to be connected to up to two speaker runs. If a second speaker run is needed, wire the second speaker wire set to the secondary set of terminal blocks.

Figure 78 Target amplified audio distribution card

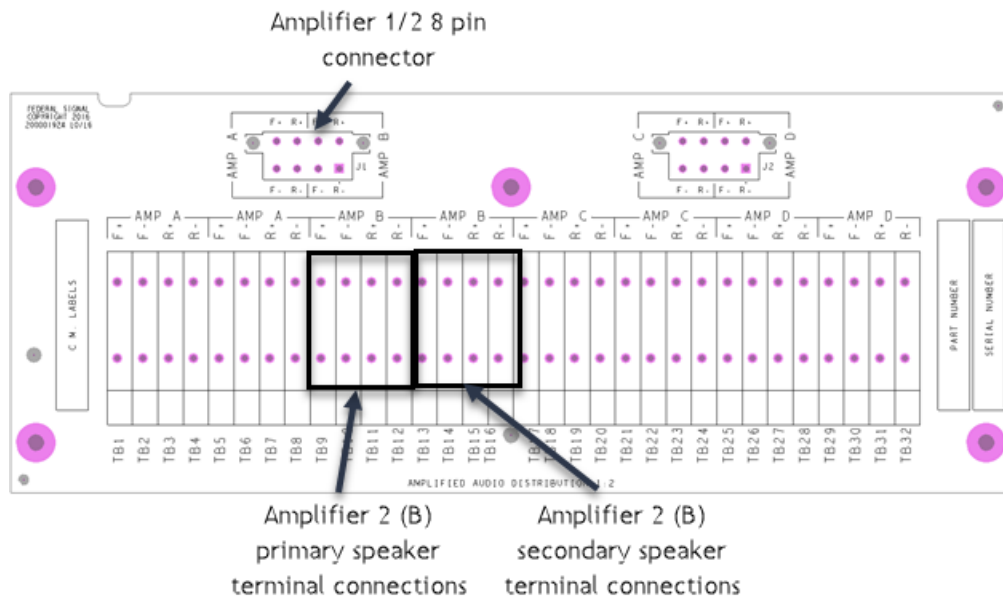

### 12.1.1 Discovering ISMT speakers using amplifier diagnostics

Discover ISMT speakers using the System Manager software application.

- Select Field Diagnostics > Equipment
- From the list, scroll to Amplifiers. Select the amplifier in the second slot of Amp Chassis 1
- From the Speakers section, click the Find All button to have the amplifier discover any ISMT speakers connected to the amplifier
- When ISMT speakers are discovered, click the Copy All To Config button to add the speakers to the system configuration

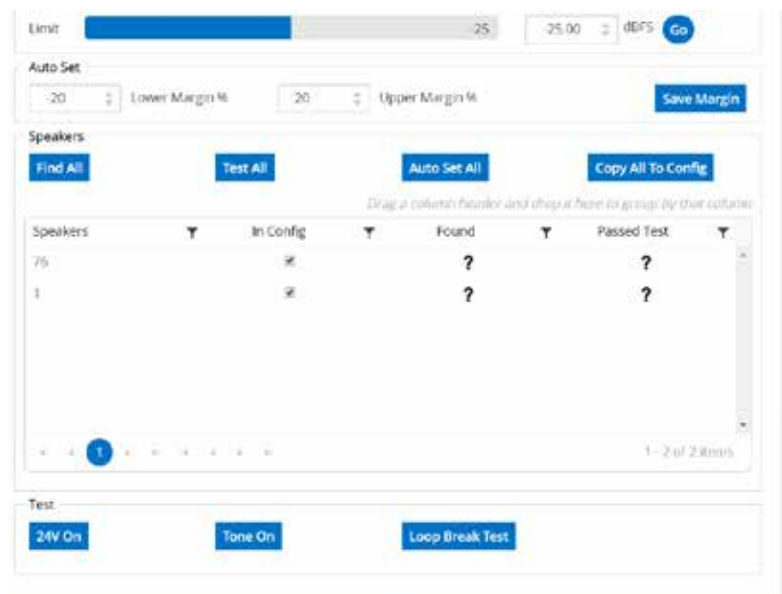

## 13.0 Terminating Beacons to MDF

### 13.1 Terminate a beacon to the beacon monitored output module

The P-BK-MON-G module consists of two connected PCBs and provides two independent beacon control and monitoring channels. The P-BK-MON-G module is a standard I/O module with the PAGASYS GEN II system and will be installed on the beacon I/O (right) panel assembly in the MDF area of the cabinet.

Figure 79 Beacon monitored output module

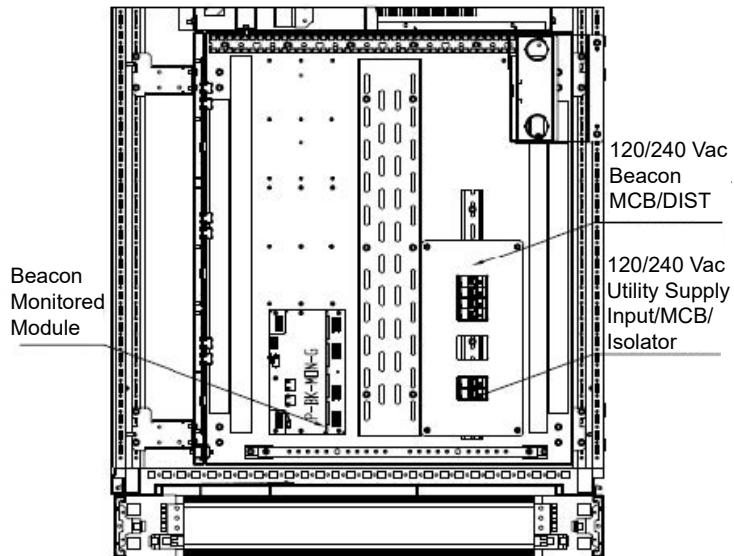



The Controller Chassis will already have I/O terminations to the beacon monitored output module beacon I/O (right) panel assembly in the MDF area of the cabinet. See RJ45 J3/J4 connections on the upper PCB in the following figure. (Both J3/J4 ports are interconnected, and the second port is used to chain additional I/O cards when needed on this I/O bus.) This view also shows the AC input connectors for the beacon monitored output module from the AC source on the lower PCB and the mini-switch used to set the modules bus address.

**Figure 80 P-BK-MON-G with RJ45 J3/J4 Connections**

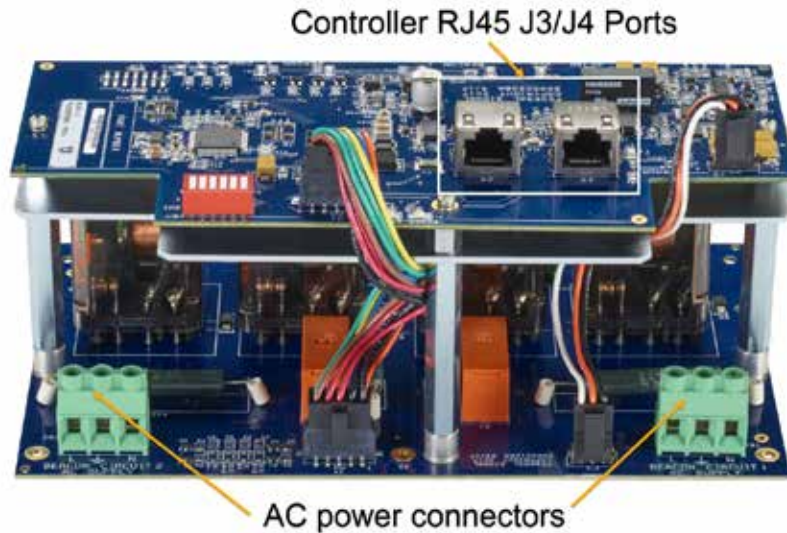

## Terminating Beacons to MDF

---

On the reverse side, the P-BK-MON-G provides four beacon channel connectors to connect the two beacon runs. The output connectors route the power to energize the beacons on the channels. The input connectors are used to terminate the beacon channel wire runs to complete the beacon loop. Each channel is designed to support 16 A of power output, so it is recommended that the number of beacons on a beacon channel not exceed this rating when active.

**Figure 81 P-BK-MON-G with Four Beacon Channels**

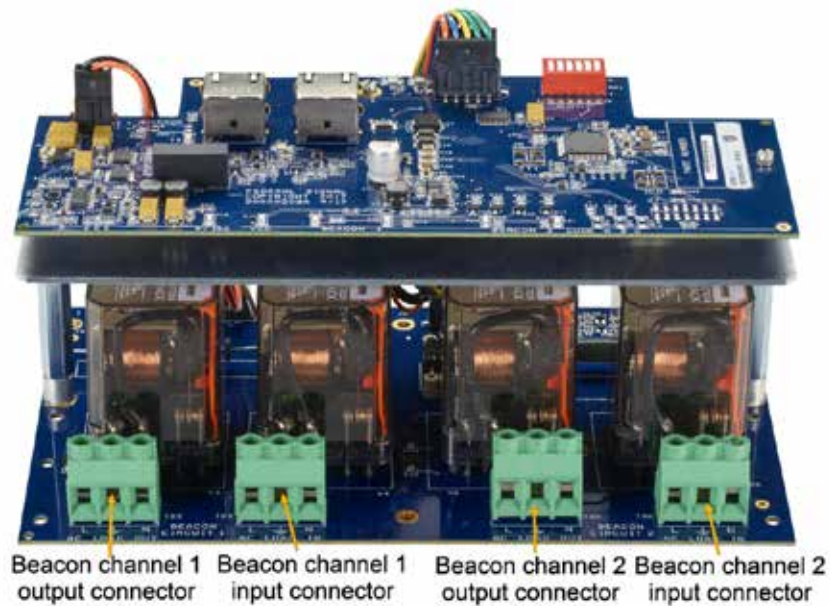

To support beacons, the beacon monitored card and channels must be configured using the System Manager software, if not already present.

- Select Configuration > Equipment.
- From the list, scroll to Beacon Monitoring Cards and select the primary controller.
- Select the monitoring card in the node list and select the Add button.
- Configure the beacon monitoring card to be consistent with I/O Bus ID and beacon monitoring card configured Node ID.
- Select the newly added beacon monitoring card and add a beacon monitoring card channel where the beacon has been installed.

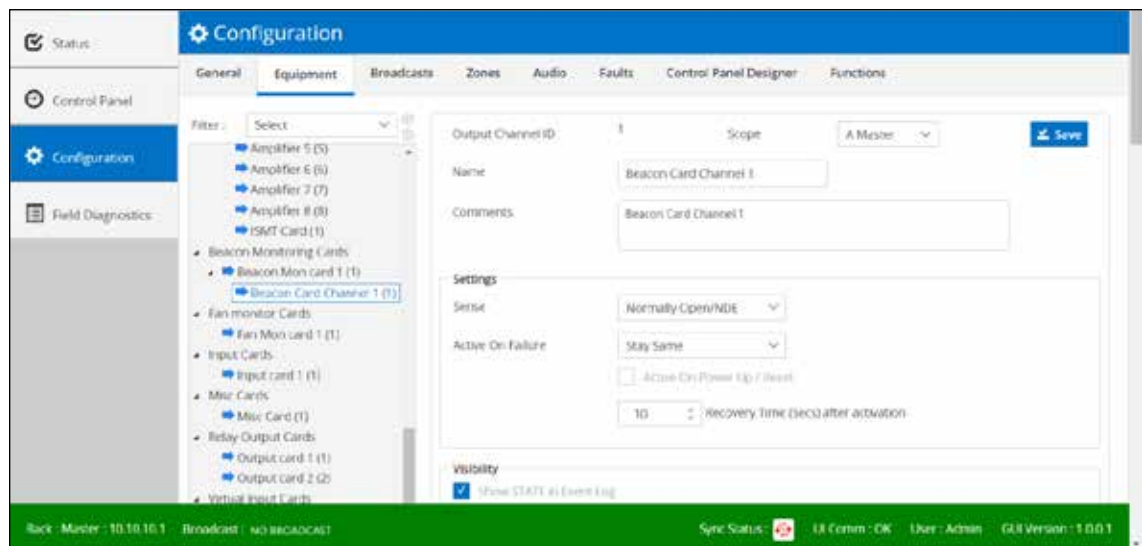

## Terminating Beacons to MDF

Beacons must be configured for the output function, selecting the function desired for the beacon and selecting broadcasts and zones that the beacons on the selected channel will activate.

Output-Function

Function:

Parameters

Broadcast List    Zone List

Broadcast Type	Name
Alarm	Test Tone
Alarm	Fire Alarm
Routine Page	PADX Playback
Duckable Alarm	PAPA2
Routine Page	Routine Page

Broadcast Type	Name
Alarm	General Alarm 75 1L
Emergency Page	EmPage
Alarm	General Alarm
Alarm	PAPA

Connection-Inputs

Inhibit    Drive

## 14.0 Control Panel Designer

### 14.1 Adding a new button and LED to a control panel to use a new broadcast

The new button and LED will be created on the default Access Panel 33 using the System Manager software application.

1. Select Configuration > Equipment.
2. If Access Panel 33 does not already exist in the equipment tree list under Access Panels > Soft Panel:
  - a. From the equipment tree list, select Access Panels
  - b. Click the down arrow and select Access Panel
  - c. Click the Add button
3. Once Access Panel 33 is available, select the panel on the equipment tree and create and configure a new Access Panel Button and Access Panel Indicator on soft Access Panel 33. (See the next section.)

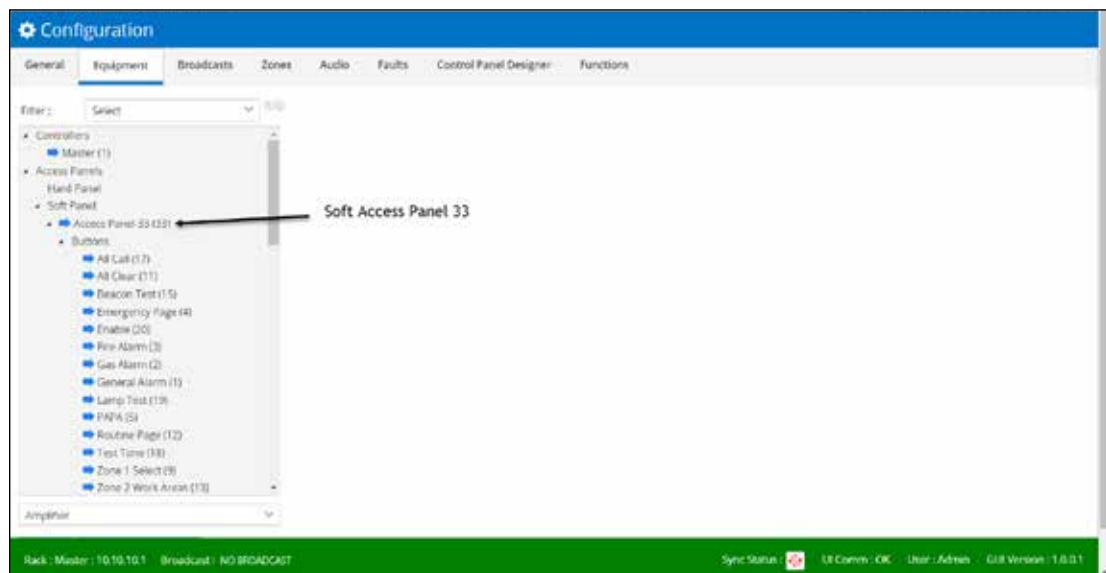

After Access Panel 33 is created, add a new button object in the Configuration > Equipment list to use an existing or newly created broadcast.

To add a new button and LED to a control panel:

1. Select Configuration > Equipment.
2. From the equipment tree list, select Soft Panel > Access Panel 33. With the access panel selected, add a new Access Panel button.

### 14.1.1 Configuring a new Access Panel Button

To configure a new Access Panel button:

1. Go to the item select list under the equipment tree, select Access Panel Button, and select Add to add the new Access Panel Button.
2. Select the new Access Panel Button and configure an available Button ID.
3. In the Name box, type a name.
4. In the Comments box, type a comment.
5. From the Settings section, click the Sense arrow: typically Normally Open/NDE.
6. From the Settings section, click the Mode arrow: typically Toggled.
7. From the Visibility section, set the Visibility desired.
8. From the Input-Function section, set the Function values. Function for a typical alarm broadcast button are `input_channel_bcast_req_fixed_zones` or `input_channel_bcast_req_variable_zones`, which differ in how output zones are selected.
9. In the Parameters section, under the Broadcast ID tab, in the Broadcast box, select the broadcast. (Use the ID for the new broadcast.)
10. In the Parameters section, under the Zone List tab, in the Broadcast box, select the zone.

### 14.1.2 Creating the new Access Indicator for the Access Panel Button

To create a new Access Panel Indicator for the Access Panel Button that was created using the System Manager software:

1. Select Configuration > Equipment.
2. From the list, scroll to Soft Panel/Access Panel 33. With the access panel selected, Add a new Access Panel Indicator.
  - a. Go to the item select list under the equipment tree, select Access Panel Indicator, and select the Add button to add the new Access Panel Indicator.
  - b. Select the new Access Panel Indicator and configure an Indicator ID that matches the Button ID for the new Access Panel Button. Give the indicator a Name, Scope, and set Output-Function to `indicator_simple`.
3. Access the Access Panel Button associated with this indicator, and add a connection under Connection-Output to drive the Access Panel Indicator under the State tab.
4. If a Lamp Test option is available on the system, access the Lamp Test button on the soft access panel, and add this new Access Panel Indicator to the list of Connection-Outputs

### **14.1.3 Adding the new button and indicator in the Control Panel Designer**

After the new button and indicator objects are created in the Equipment list, add the new button and indicator in the Control Panel Designer using the System Manager software:

- 1.** Select Configuration > Control Panel Designer.
- 2.** Copy an existing access panel button and indicator.
- 3.** Paste and move the new button and indicator to the desired location.
- 4.** Select the new button, open Properties on the right edit window, edit any attributes that need changes, and select the Controller ID# of the new Access Panel button created in Equipment under Access Panel 33.
- 5.** Select the new indicator, open Properties on the right edit window, edit any attributes that need changes, and select the Indicator ID# of the new Access Panel indicator created in Equipment under Access Panel 33.
- 6.** Once the button and the indicator have been set up as needed, changes can be locked out for these objects by clicking the lock icon on the top of the properties window. (Open lock changes to locked.)
- 7.** Click Save.

## 15.0 Configuring a Broadcast

### 15.1 Creating a new broadcast for PAGASYS GEN II

Creating a new broadcast in the PAGASYS GEN II System Manager software starts with new audio to support the broadcast.

1. Select Configurations > Audio > Recorded Messages tab.

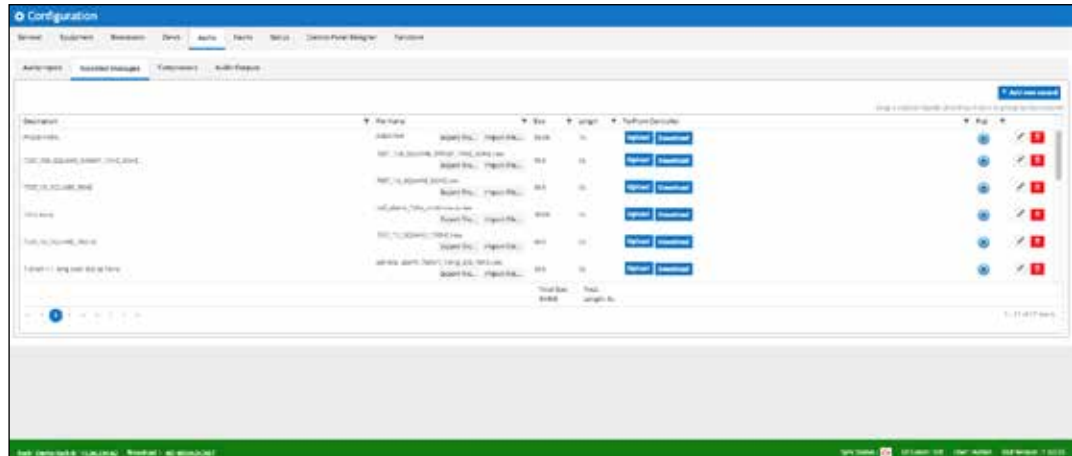

2. Click the + Add new record button to add a new audio file to recorded messages. The New Message dialog box appears.

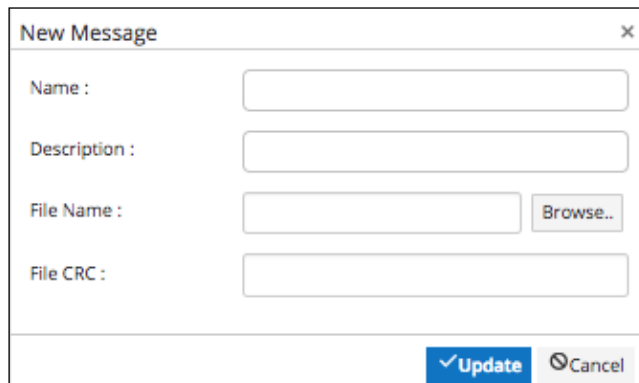
A dialog box titled "New Message" with a close button (X) in the top right corner. It contains four input fields: "Name:", "Description:", "File Name:", and "File CRC:". The "File Name:" field has a "Browse..." button to its right. At the bottom of the dialog, there are two buttons: "Update" (with a checkmark icon) and "Cancel" (with a circle icon).

3. Give the new audio a name and description, and select an audio file using the File Name/Browse button. (Audio files must be 16 bit, 48 kHz.) The system will calculate the File CRC for the audio file. After the file loads successfully, click the Update button to return to the audio list. Ensure that you select Upload next to the new audio to upload it to the controller.



## 15.2 Adding a new button and LED to a control panel

After creating a new recorded message (or using an existing message), create a Broadcast using the audio with the System Manager software.

1. Select Configuration > Broadcast.

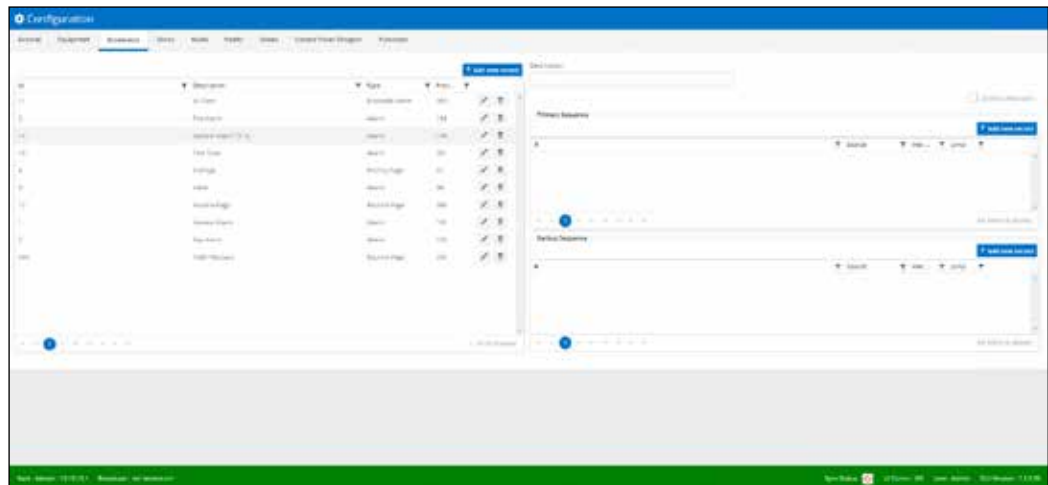

The following dialog box shows the Ducking Attenuation field.

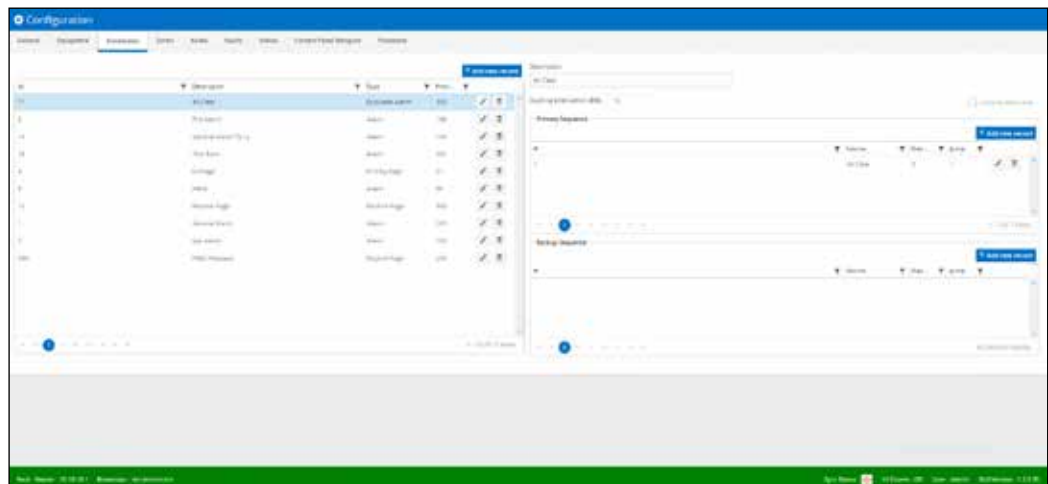

## Configuring a Broadcast

---

- Click the + Add new record button to add a new broadcast. The New Broadcast dialog box appears.

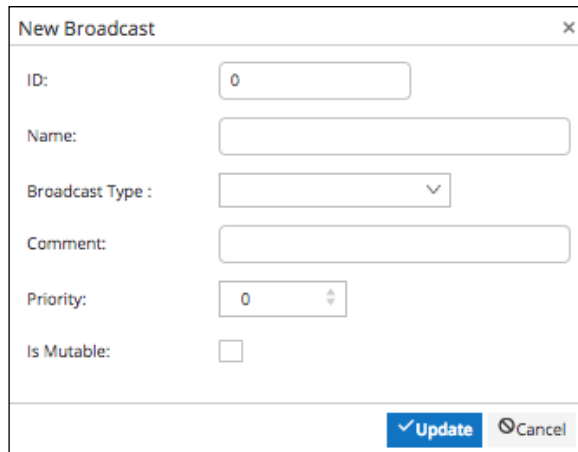

The 'New Broadcast' dialog box contains the following fields and controls:

- ID:
- Name:
- Broadcast Type:
- Comment:
- Priority:
- Is Mutable:
- Buttons:

- Give the new broadcast an ID, Name, select a Broadcast Type, add a Comment, and set the priority. Lower priority value takes precedence over higher values.

**NOTE:** The ducking attenuation is needed only when the broadcast type is a Duckable alarm.

- Click Update to save the new broadcast under the Name.
- Select the new broadcast in the list, then select the + Add new record button under the Primary Sequence section. The New Primary Sequence dialog box appears.

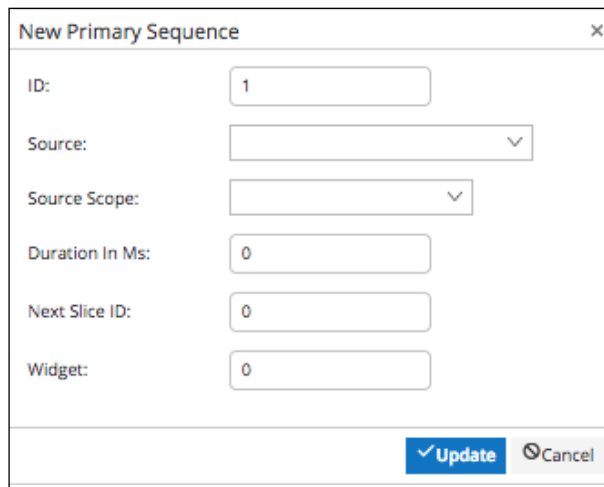

The 'New Primary Sequence' dialog box contains the following fields and controls:

- ID:
- Source:
- Source Scope:
- Duration In Ms:
- Next Slice ID:
- Widget:
- Buttons:

- Select an audio source, such as the new audio you added, set the Source Scope, select the Next Slice ID to generate a continuous alarm. Select 1 to continuously play single audio, or select next audio in sequence to play more than one audio in sequence.

## 16.0 Programming PABX Interface

### 16.1 Configuring the Miscellaneous Card

To configure the Miscellaneous card to create a PABX playback broadcast, first create a PABX Playback Broadcast to drive the playback message after dialing into the PABX interface and leaving a message using the System Manage software.

1. Select Configuration > Broadcasts.

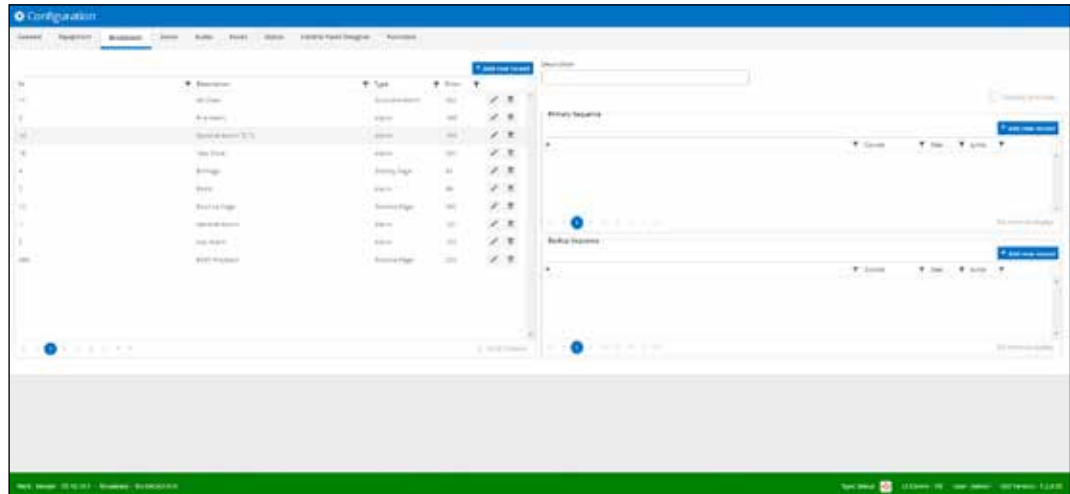

2. Click the + Add new record button to add a new broadcast. The New Broadcast dialog box appears.

**New Broadcast** ✕

ID:

Name:

Broadcast Type:

Comment:

Priority:

Is Mutable:

3. Create a new PABX Playback Broadcast.
  - a. Set ID to the desired value.
  - b. Set Name to the desired value. In this case, we are using PABX Playback.
  - c. Click the down arrow to set the Broadcast Type to Routine Page.
  - d. Add a Comment if needed.
  - e. Select the Priority to an appropriate value for your system.
  - f. Leave Is Mutable unchecked.
  - g. Click Update to save the broadcast.

4. Select the new broadcast you created, and then click the + Add new record button under the Primary Sequence section to select a source for the broadcast. The New Primary Sequence dialog box appears.

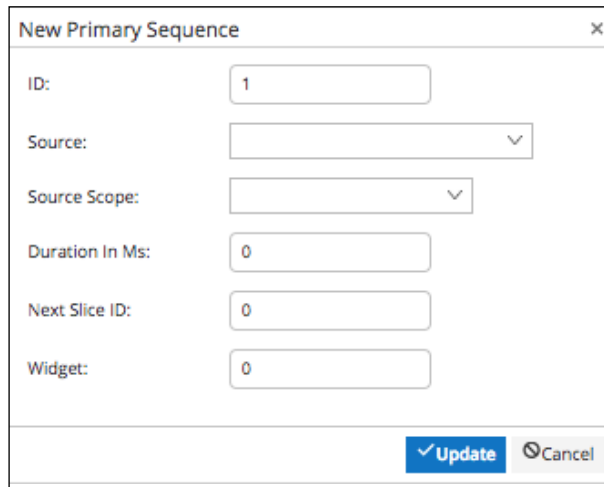

The image shows a dialog box titled "New Primary Sequence" with a close button (X) in the top right corner. It contains several input fields: "ID:" with the value "1", "Source:" with a dropdown arrow, "Source Scope:" with a dropdown arrow, "Duration In Ms:" with the value "0", "Next Slice ID:" with the value "0", and "Widget:" with the value "0". At the bottom right, there are two buttons: "Update" (with a checkmark icon) and "Cancel" (with a close icon).

5. Select source PABX Recording, with the appropriate scope. Set the Duration in Ms and the Next Slice ID. Set Widget to the same value as the Broadcast ID.
6. Click Update to save Primary Sequence #1.

## 16.2 Configuring the Miscellaneous Card

To configure the Miscellaneous card to enable connection to PABX system, including programming telephone and answering settings using the System Manager software.

1. Select Configuration > Equipment > Misc Card.

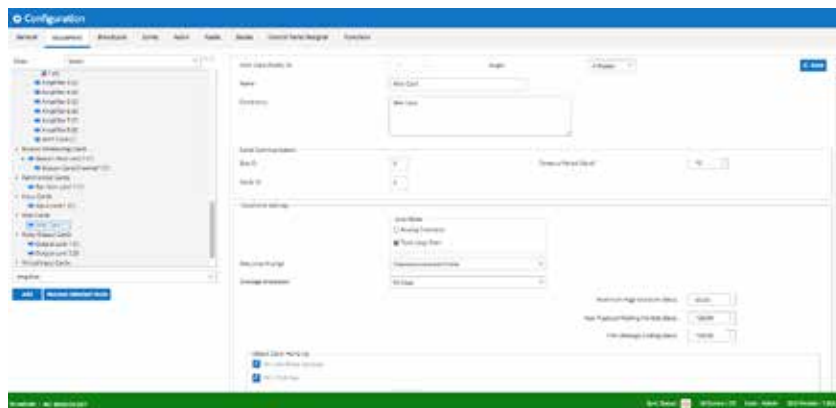

2. Configure the Telephone Settings.
  - a. Set the line mode, typically Analog Extension. (See the next section.)
  - b. Set the Welcome Prompt to an available broadcast message.
  - c. Set the Message Broadcast to an available broadcast message.
  - d. Set the Maximum Page Duration, Max Playback Waiting Periods, and Trim Message Ending to desired values (for example, 60/120/100 seconds).
3. Configure the Detect Caller Hang Up values. If the On DTMF Key check box is selected, enter the DTMF key desired.

4. Configure the Abort Call. If the On DTMF Key check box is selected, enter the DTMF key desired.
5. Set the option to Skip Welcome. If the On DTMF Key check box is selected, enter the DTMF key desired.
6. From the Zone Selection section, select the zones for available PABX broadcasts.

### 16.3 Analog Extension Mode

The call is set up by the PABX sending a ringing signal, and the PAGASYS interface responding to that by seizing the line.

Depending on the PABX, the call may be terminated using one of the following methods:

- Line reversal/line break (also known as K/P reversal)
- Call progress tone

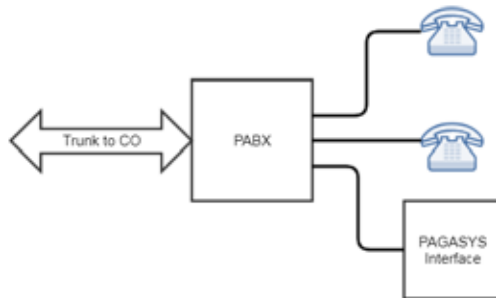

### 16.4 Loop Start Mode

The PAGASYS interface puts a voltage on the line, but initially, no current flows.

The call is set up by the PABX going off-hook, which causes current to flow in the line. The PAGASYS interface detects this with a current sensor.

The call is terminated by the PABX going on-hook, which causes the current flow to stop.

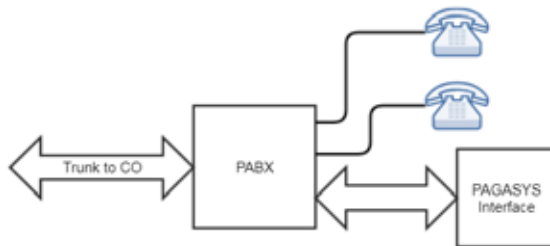

## 17.0 Configuring local speaker mute

### 17.1 Configuring local speaker mute to avoid feedback

When making a live page from the local microphone in a zone, feedback can be prevented by muting the local speaker. The following procedure shows how to mute a speaker using the Relay Output Module. As an example, we assume that Amplifier Chassis 1 is already terminated to the eight-pin connector on the amplifier audio distribution card in slot 1 on the audio (left) panel assembly in the MDF area, and the relay output module, P-SPDT-G, is already installed on the rear MDF I/O panel, on the right side.

To mute a speaker using the Relay Output Module:

1. On amplified audio distribution card 1, terminate the wires to the primary amp a forward+ (F+) and forward- (F-) spring terminal block.

**Figure 82 Target amplified audio distribution card**

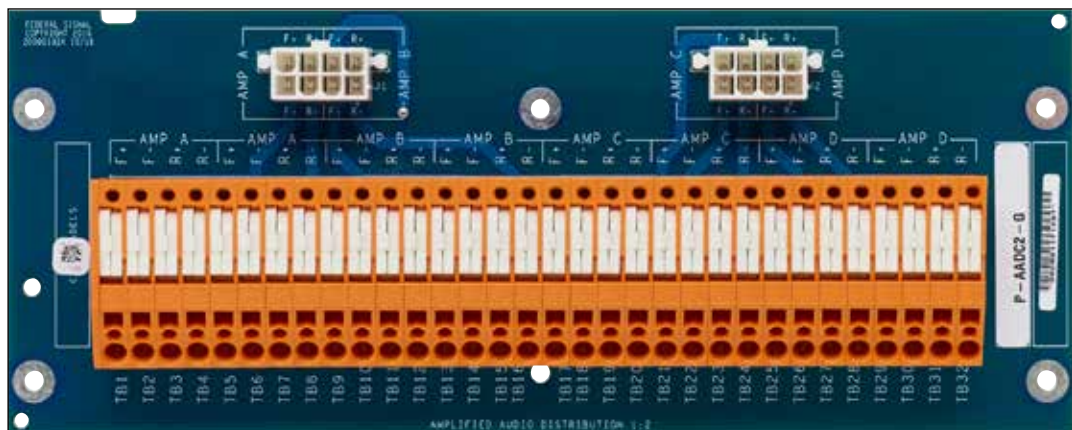

2. Terminate the other end of the wire on the relay output board, F+ to TB1 pin 3 (1 COM) and F- to TB1 pin 6 (2 COM).
3. Connect the speakers to be muted to pin 1 (F+ to 1 NC) and pin 4 (F- to 2 NC). This will allow the speakers to operate normally until the relay output board is changed to normally open.

**Figure 83 Target amplified relay output board**

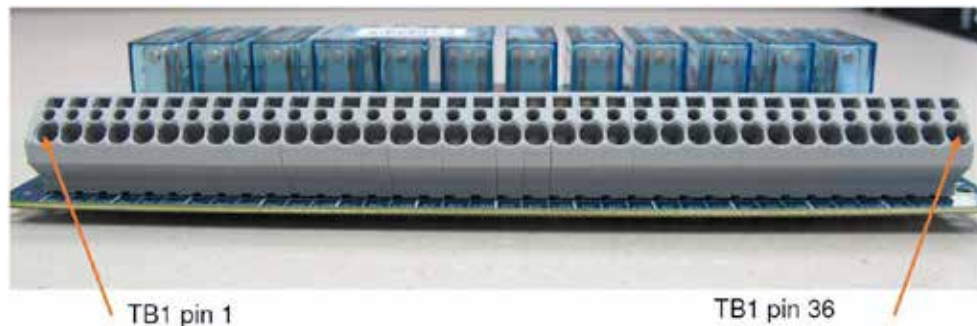

**Table 49 Relay output board terminal block pinout for speaker muting**

Terminal Block	TB1 Pin #	Relay contact Relay
1	1 NC	RL1
2	1 NO	RL1
3	1 COM	RL1
4	2 NC	RL2
5	2 NO	RL2
6	2 COM	RL2

4. Configure the Relay Output card using the System Manager software.
  - a. Make sure the Relay Output card is already in the configuration equipment tree. If not, add the card.
  - b. Select the Relay Output card (should be card 1), and then add two relay output card channels: one for the F+ relay and one for the F- relay. Ensure the configuration matches the physical location of the speaker wiring from the prior step.
  - c. Configure the relay output card channels as follows:
    - Sense = Normally Open/NDE
    - Active on Failure = Stay Same
    - Function = output\_channel\_bcast\_active\_any
    - Broadcast List = Priority Page and Routine Page (or existing live broadcasts you wish to mute)
    - Zone List = local zone correlating to the amplifier wiring from the prior step
  - d. Save changes, upload to the controller, and restart controller to ensure changes are permanent.

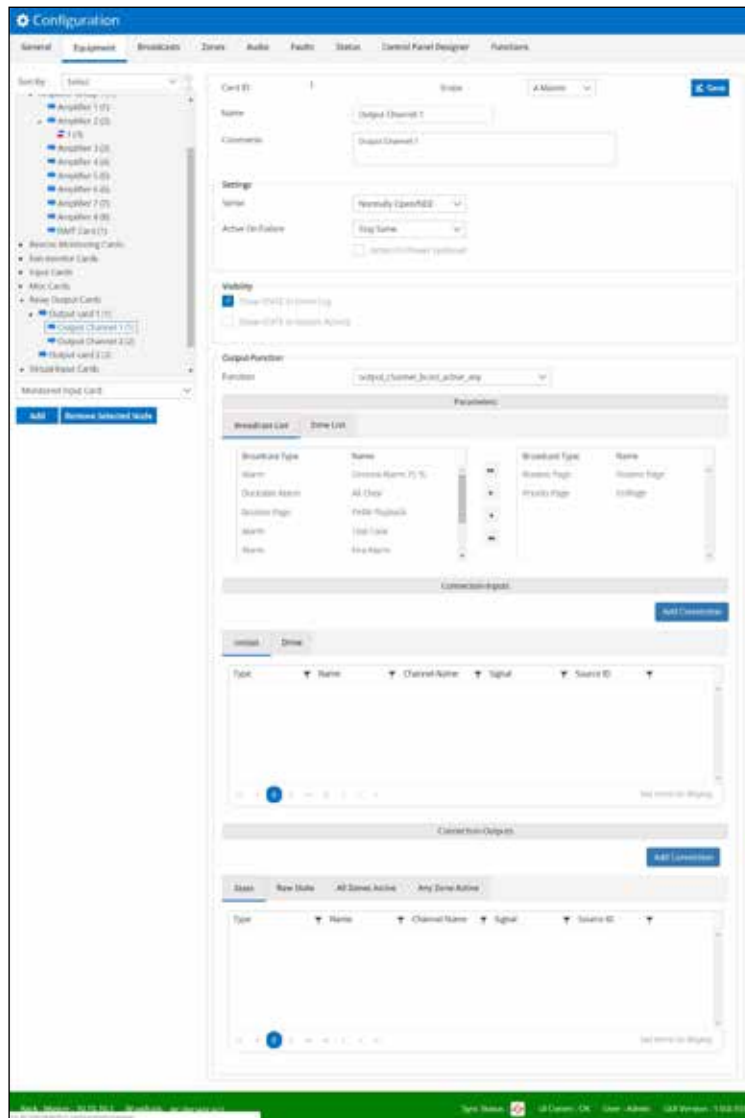

5. Make a live broadcast for one of the broadcasts configured and ensure that it plays only on speakers that are outside of the muted zone.



## 18.0 Configuring an Amplifier

### 18.1 Creating a new amplifier entity in the equipment tree

When an amplifier is not configured in the System Manager GUI but is physically present in the Amplifier Chassis, the System Controller will not communicate with it, and the status LED on the amplifier will flash.

To initiate communication between the amplifier and controller, the amplifier must be configured in the System Manager equipment tree.

1. Ensure the amplifier PCB is installed in an Amplifier Chassis. The amplifier number will relate to chassis number and location in the chassis. Amplifier Chassis one will have amplifiers 1-4, Amplifier Chassis two will have amplifiers 5-8, and so on.
2. Select Configuration > Equipment.
3. If no amplifier group exists, one must be created before adding an amplifier.
  - Select the Amplifiers object in the equipment tree and Add an Amplifier Group using the item select list under the equipment tree.
4. When a target Amplifier Group exists, select the Amplifier Group and Add an Amplifier on the equipment tree using the item select list under the equipment tree.
5. See the next section on how to configure the new Amplifier.

Amplifier Chassis one will have amplifiers 1-4, based on the slot, starting from the left. Additional chassis will start numbering where the prior chassis left off; and chassis two will have amplifiers 5-8, and so on.

**Figure 84 Amplifier Chassis**



Figure 85 Defining an Amplifier Chassis

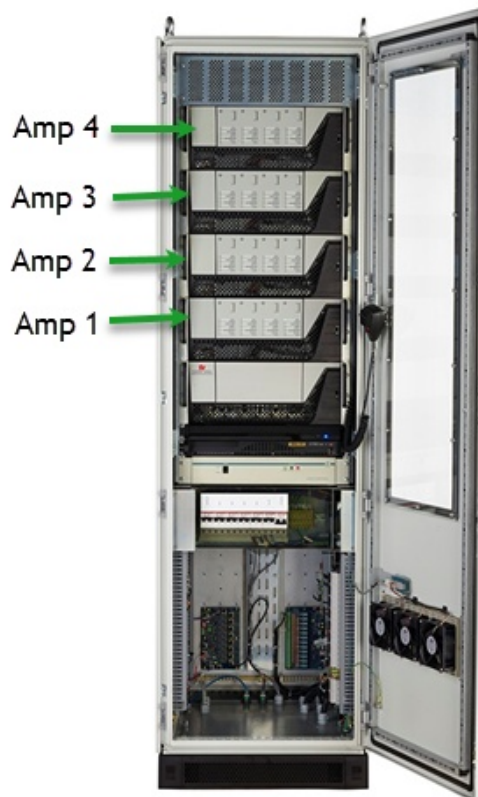

### 18.2 Configuring a new amplifier entity in the equipment tree

After the amplifier is added to the equipment tree, configure the amplifier using the System Manager software:

1. Select Configuration > Equipment and select the amplifier created in the prior section.
2. Give the new amplifier a Name, Comment, an amplifier ID consistent with its chassis and slot location. (See the prior section.) Select scope (A Master for a standalone system, Duplicated for A/B system).
3. Select the Monitoring Option (typically Impedance Monitoring unless the amplifier is standby or supports ISMT), select a Zone Standby, and choose other options if needed.

4. Add Local Properties by selecting + Add new record. The New Local Properties dialog box appears.

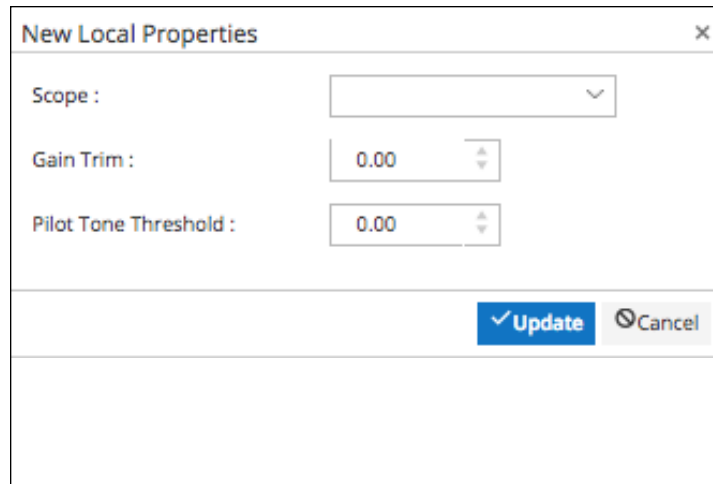

The image shows a dialog box titled "New Local Properties" with a close button (X) in the top right corner. The dialog contains three input fields: "Scope" with a dropdown arrow, "Gain Trim" with a numeric value of 0.00 and up/down arrows, and "Pilot Tone Threshold" with a numeric value of 0.00 and up/down arrows. At the bottom right, there are two buttons: "Update" (with a checkmark icon) and "Cancel" (with a circle and slash icon).

- a. Set the Broadcast Gain between -30 and 0
- b. Set initial Impedance Lower Limit and Upper Limit and Pilot Tone Threshold. (These values can be changed in Field Diagnostics after evaluating measured Critical Path [Pilot Tone] Monitoring and Impedance Monitoring)
- c. Click Update.

## 19.0 Installing Hardware Access Panel

### 19.1 Connect Hard Access Panel to the PAGASYS GEN II System

PAGASYS GEN II systems can be configured with soft or hard access panels to initiate broadcasts or live messages. The soft access panel is embedded in the System Manager, referred to as the control panel.

The hard access panel is an external device connected to the PAGASYS GEN II system via a four-wire interface. The four-wire interface is either un-terminated or terminated with an RJ45 interface. If the hard access panel has an un-terminated four-wire interface (typical), the cable may be terminated onto one of the passive terminal block cards (P-PTBC-G) in the MDF area at the bottom of the cabinet.

The standard configuration for the PAGASYS GEN II system includes two of these boards on the rear left-side MDF panel, and the eight ports from the access panel Mux 1 card are terminated to these cards' RJ45 ports by default. The four-pair wires from the access panel should be attached to the terminal block on these cards corresponding to the desired access panel number. If terminated with an RJ45 interface, the cable may be terminated directly into one of the access panel ports on the Controller Chassis access panel Mux 1 card.

**Figure 86 Passive Terminal Block Card (P-PTBC-G)**

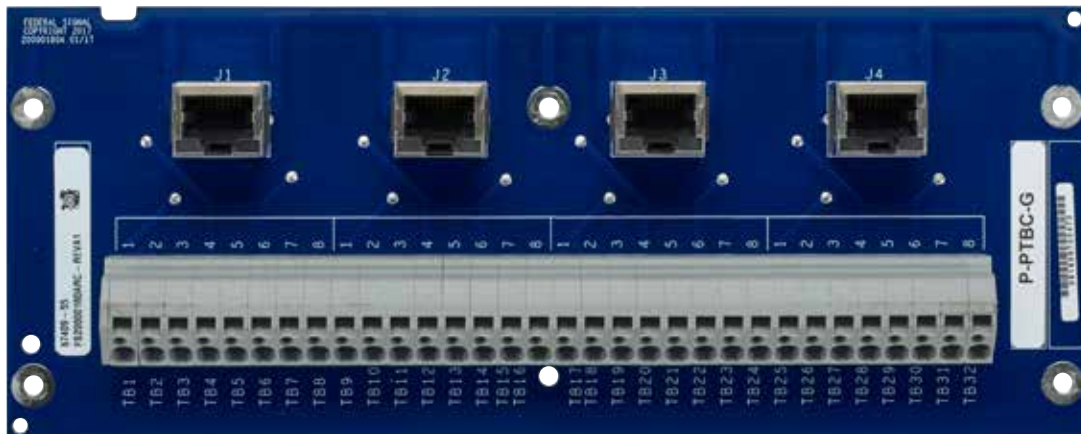

## 19.2 Configure the panel in System Manager

Once the hard access panel is connected to the PAGASYS GEN II system, configure the panel using the System Manager software. If a soft access panel is already created with similar functions to what is needed on the hard access panel, clone the soft access panel.

To clone the soft access panel:

1. Select Configuration > Equipment > Access Panel.

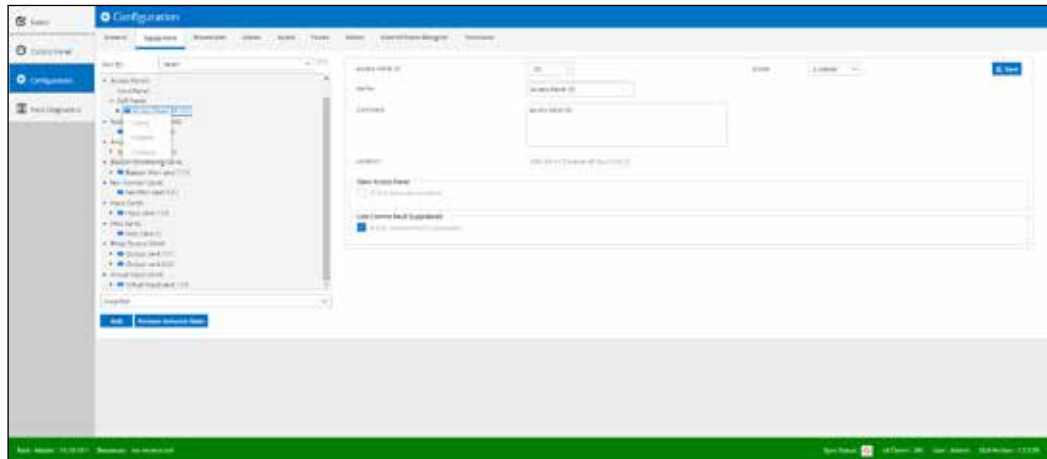

2. Right-click the existing soft access panel (Access Panel 33, most likely) and select Clone. The Select Access Panel dialog box appears.

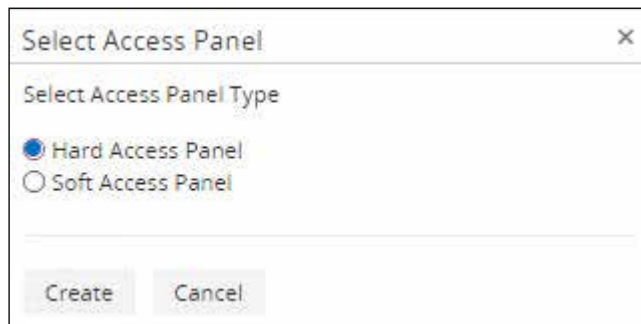

3. Click Hard Access Panel.
4. Click Create.

## Installing Hardware Access Panel

When the hard access panel is cloned from another panel, the buttons and indicators for the new access panel are available on the System Manager equipment tree. In this example, hard access panel 1, the user must configure the Buttons and Indicators attributes (Function, Broadcasts, Zone selections, and Input/Output Connections) to use the access panel.

To configure the new hard access panel:

1. Select Configuration > Equipment > Hard Panel. Select the new Access Panel just created.
2. The General Alarm example that follows is fully configured. Use the existing soft access panel attributes to define new access panel configuration.

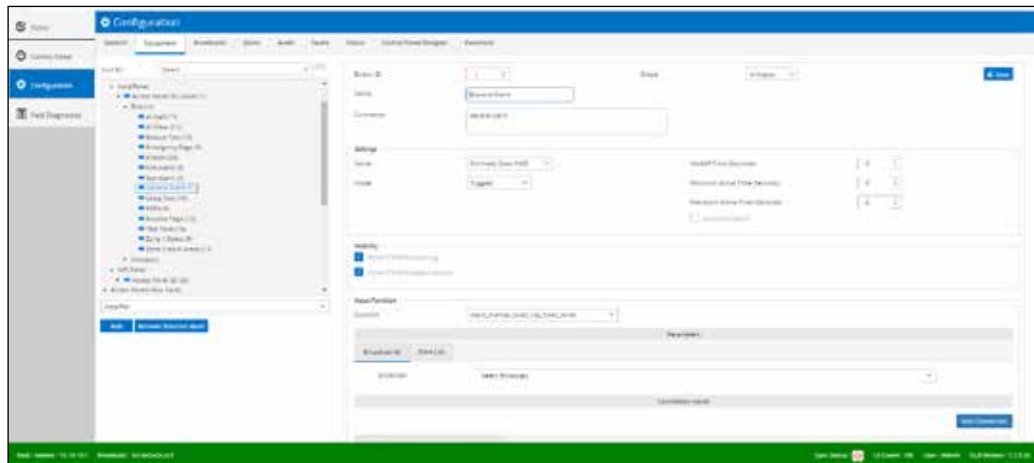

3. Select File > Upload Config to Controller to upload the access panel to the System Controller.
4. Select File > Restart Controller to restart the System Controller to implement the new configuration.

## 20.0 Ordering PAGASYS GEN II Systems

### 20.1 Ordering Standard Cabinets and Accessories

Federal Signal offers an online configurator to allow users to order PAGASYS GEN II kits. Items that can be ordered include PAGASYS GEN II kits and service parts. The web link to the configurator is as follows:

<https://configurator.pagaglobal.com/Index>

**Figure 87 PAGASYS GEN II Configurator**

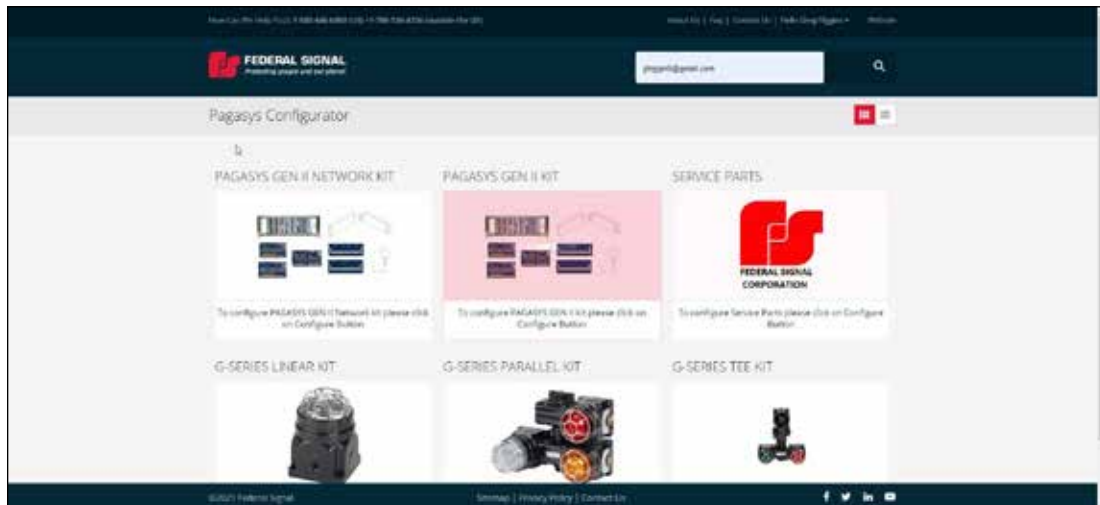

The PAGASYS configurator allows the user to select standard PAGASYS GEN II kits, starting with IP enabled configuration (P-NET-G-IP), non-networked (P-NET-G) configuration, or Service Parts at the entry point to configurator. For the networked/non-networked configurations, the available kits with descriptions are reflected below.

#### **PK-NET-G and PK-NET-G-IP**

PK-NET-G and PK-NET-G-IP, controller kits, include the appropriate PAGASYS GEN II controller (non-networked or networked), along with the I/O cards normally installed on the MDF I/O panel connected to the controller I/O PCB, controller backplane, internal AP MUX, amplifier audio MUX, processor, miscellaneous, I/O interface, and AC power supply cards), the controller cabinet slide assemblies, mounting screws/nuts, and the microphone (with mounting bracket) that is normally connected to the controller miscellaneous card. This kit does not include CAT5 wires normally connecting the controller to the I/O cards or the amplifier. This wiring is included in the cabinet kit, model PK-CABINET-G.

#### **GENII-RC**

GENII-RC, remote controller, is a new 2U form factor rack-mountable mini-controller that provides the user the capability of supporting PA/GA services remotely using an Ethernet interface without the need for a full PAGASYS GEN II cabinet. The configurator allows the user to select either the AC (120/240 Vac) or DC (48 Vdc) model.

#### **PK-Axxxx-G**

PK-Axxxx-G, the amplifier kits include the Amplifier Chassis configured with the appropriate number of amplifier channel cards (1-4), selected for output audio voltage of  $100\text{ V}_{\text{RMS}}$  or  $70\text{ V}_{\text{RMS}}$ . The kit also includes the amplifier cabinet slide assemblies, mounting

screws/nuts, one P-AADC2-G amp audio distribution card with audio output cable, and an amplifier standby cable.

### **PK-ISMT-G**

PK-ISMT-G, ISMT kit, provides the ISMT PCB that will be installed in the Standby Amplifier Chassis, next to the slot 4 amplifier channel card. The ISMT card is not installed in the chassis when shipped.

### **GENII-RA700 and GENII-RA700-70**

GENII-RA700 and GENII-RA700-70, remote amplifier, is a new 2U form factor rack-mountable 2 x 350 W amplifier that provides the user the capability of supporting PA/GA services remotely using an Ethernet interface without the need for a full PAGASYS GEN II cabinet. The configurator allows the user to select either the 100 V<sub>RMS</sub> or 70V<sub>RMS</sub> model.

### **PK-FAN-G**

PK-FAN-G, fan kit, includes the fan power supply assembly, the fan termination PCBs (two), six fans, the fan upper/lower cable assemblies, screws/washers/nuts.

### **PK-BK-MON-G**

PK-BK-MON-G, the beacon control and monitor kit, includes the beacon monitor assembly and mounting screws. The MDF kit includes the mounting location for the beacon monitor assembly, but does not include the module.

### **P-SERV-G and P-SYSMGR-G**

P-SERV-G and P-SYSMGR-G, the server kit includes the 1U Windows<sup>®</sup>-based server, the 1U LCD/keyboard, cable assemblies to connect the server and LCD/keyboard, and the PAGASYS GEN II System Manager software that is needed to configure the System Controller. The server options include standard LCD/keyboard or touchscreen LCD/keyboard. If the server is not needed, the user can purchase the software only for a reduced price.

### **P-GLOBALIZATION-G**

P-GLOBALIZATION-G, if the server or System Manager software is selected, the configurator gives the user the option of selecting the globalization kit. The globalization kit allows the user to select up to ten different languages for System Manager language support. If one of the ten available languages is not sufficient, contact your sales representative for the availability of other languages.

### **P-TRANS-SW-G-xxx**

P-TRANS-SW-G-xxx, the transfer switch model provides a source for redundant power supplies for the PAGASYS GEN II system and is available in 120 Vac or 240 Vac models.

### **P-AP-XXXX-G**

P-AP-XXXX-G, the six access panel models include three access panel types, desk mount (DM), wall mount (WM), and rack mount (19). Each model is available in a safe area (SA) or explosive environment (EX) versions. EX models require the purchase of the optional barrier card to provide an Intrinsically Safe barrier between access panels that are mounted in a hazardous area and the PAGASYS GEN II cabinet.



**P-AP-KYB-COVER**

P-AP-KYB-COVER, the access panel keyboard cover is an access panel option that protects the access panel keypad, helping to prevent accidental key selections.

**P-MIC-EXWMx-316-G**

P-MIC-EXWMx-316-G, the microphone station models, either one button or two buttons, provide an IP66 rated pushbutton station solution that can be used in an EX environment when connected to an optional barrier card.

**P-IS-BARRIER-G**

P-IS-BARRIER-G, the barrier card is needed when the PAGASYS GEN II system is connected to an access panel or microphone station in an EX environment for intrinsically safe operation.

**P-GAP-G**

P-GAP-G, Global Access Panel, is used to interface with networked controllers. Includes a Windows<sup>®</sup>-based server, GAP software, analog microphone, and a Dante interface to translate live voice to digital format.

**PK-CABINET-G**

PK-CABINET-KIT is the standard Federal Signal cabinet. This kit includes parts in a standard PAGASYS GEN II system that are not offered in the other kits, such as the standard 800 x 600 x 2000 cabinet, metalwork, wiring, and so forth.

**PK-POWER-G and PK-POWER-G-120**

PK-POWER-KIT provides the power panel assembly above the MDF area of the standard PAGASYS rack.

**PK-MDF-KIT**

PK-MDF-KIT includes the four MDF panels, the audio panel, the I/O panel, the power panel, and the rear upper MDF panel (used to attach the rear of the fan control module to cabinet). These panels do not include the audio or I/O PCBs, or the beacon monitor assembly, as these PCBs are available in other kits.

The Service Parts configurator allows the user to select PAGASYS GEN II server parts for the system controller, amplifiers, or I/O cards.

Once configurations are selected, the user enters sold/ship to information, and the quote generated can be printed or emailed as needed.

## 20.2 Ordering PAGASYS GEN II Service Parts

PAGASYS GEN II controller service parts are available for spares or replacement of all PCBs included with the Standard Controller Chassis.

**Table 50 PAGASYS GEN II Controller Service Parts**

Model	Description
K-P-NET-G	Controller Chassis Service Model
K20000170	Controller Backplane Service Model
K-P-IAMC-G	Internal AP MUX Card GEN II Service Model
K-P-AAMC-G	Amplifier Audio MUX Card GEN II Service Model
K-P-CPC-G	Processor Card GEN II Service Model
K-P-CMC-G	Miscellaneous Card GEN II Service Model
K-P-IOIC-G	I/O Interface Card GEN II Service Model
K-P-ADPS-G	120/240 Vac Power Supply GEN II Service Model
K-P-EAMC-G	External AP MUX Card GEN II Service Model

PAGASYS GEN II controller service parts are available for spares or replacement of all PCBs included with the Standard Controller Chassis.

**Table 51 PAGASYS GEN II Amplifier Service Parts**

Model	Description
K20000154	Single backplane signal PCB card service part
K20000155	Single backplane power PCB card service part
K-P-ISMT-G	Single ISMT line card service part
K20000150	Single amplifier PCB card 100 V service part without Transformer
K12000775	Transformer 300 W, 100 V Audio service part
K20000150-70	Single amplifier PCB card 70 V service part without Transformer
K12001655	Transformer 300 W, 70 V Audio service part

PAGASYS GEN II controller service parts are available for spares or replacement of all PCBs included with the Standard Controller Chassis.

**Table 52 PAGASYS GEN II I/O and Terminal Block Service Parts**

Model	Description
K-P-APIC-G	Access Panel Aggregator I/O Card GEN II, Service Model
K-P-16DIN-G	Digital Input I/O Card GEN II, Service Model
K-P-BK-MON-G	Beacon Monitoring I/O GEN II, Service Model
K-P-SPDT-G	Relay Output I/O Card GEN II, Service Model
K-P-FCMC-G	Fan Control/Monitoring I/O Card GEN II, Service Model
K-P-MONIC-G	Monitored Input I/O Card GEN II, Service Model
K-P-PTBC-G	Passive Terminal Block Card, Spring, Service Model
K-P-CPIC-G	Cable Power Injector I/O Card, Service Model
K-P-AADC1-G	Amplifier Audio Distribution Card 1:1, Spring, Service Model
K-P-AADC2-G	Amplifier Audio Distribution Card 1:2, Spring, Service Model
K-P-AADC4-G	Amplifier Audio Distribution Card 1:4, Spring, Service Model

<b>Model</b>	<b>Description</b>
K-P-AADC8-G	Amplifier Audio Distribution Card 1:8, Spring, Service Model
K-P-FWTC-G	Fan Wiring Termination Card, Service Model
K-P-IS-BARRIER-G	IS Barrier Board Service Model

## **21.0 Getting Technical Support**

For technical support, contact:

Federal Signal  
Technical Support  
Phone: 800-524-3021 or 708-534-4790  
Email: [techsupport@fedsig.com](mailto:techsupport@fedsig.com)  
[www.fedsig.com](http://www.fedsig.com)



**FEDERAL SIGNAL**  
Safety and Security Systems

2645 Federal Signal Drive  
University Park, Illinois 60484

[www.fedsig.com](http://www.fedsig.com)

Technical Support      800-524-3021 (US) • +1 708-534-4790 (International)